

THIS INSTRUCTION BOOKLET CONTAINS
IMPORTANT SAFETY INFORMATION. PLEASE
READ AND KEEP FOR FUTURE REFERENCE.

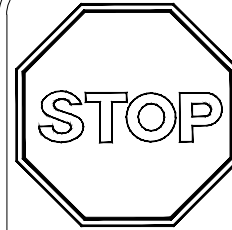

DO NOT RETURN PRODUCT TO THE STORE
Individual stores do not stock parts.

Lot Number: _____

Date Of Purchase: ____/____/____

If a part is missing or damaged, call our toll-free customer service line.
We will gladly ship your replacement parts FREE of charge.

For prompt, reliable service please have your assembly manual ready.

Recommended # of people needed for assembly:2
(However it is always better to have an extra hand.)

Spanish translations are located in the center of this manual.

Thank you for purchasing .

BEFORE STARTING

- Read each step carefully before starting. It is very important that each step of instruction is performed in the correct order. If these steps are not followed in sequence, assembly difficulties will occur.
- Make sure all parts are included. Most board parts are labeled or stamped on the raw edge.
- Work in spacious area, preferably on a carpet, near the place the unit will be used.
- Have the following tools close at hand.
- Do not use power tools to assemble your furniture. Power tools may strip or damage the parts.

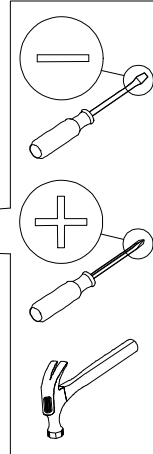

HELPFUL HINTS

- Visit our website for assembly video clips.
- Call our toll free number if you need assistance.
- Compression dowels are tapped in with a hammer.
- Back panels provide stability and support. Use all the nails provided. Units without the back panel installed may collapse.
- When tapping nails into a board, be sure there are equal margins on all side to square the unit.
- Move your new furniture carefully, with two people lift and carry the unit to it's new location.
- Never push, drag or scoot your furniture (especially on carpet).
- Your furniture can be disassembled and reassembled to move.
- Additional parts are available for a nominal fee.

For help with assembly, identifying parts, product information or to order parts, please contact us

PARTS

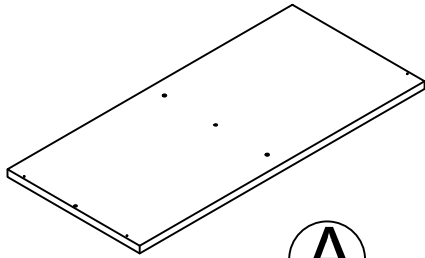

TOP

A

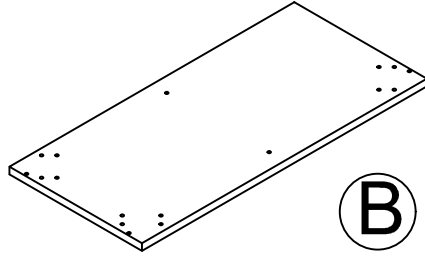

BOTTOM

B

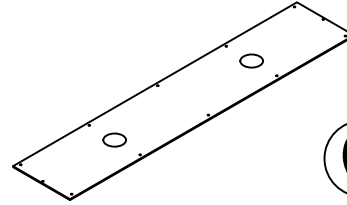

BACK PANEL

C

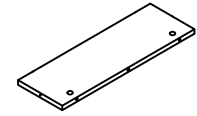

LEFT SIDE PANEL

D

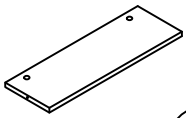

RIGHT SIDE PANEL

E

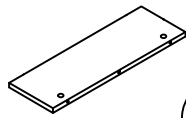

PARTITION

F



LEG

G

QTY:4

PARTS

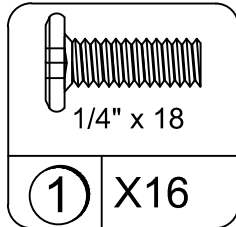

1/4" x 18

① X16

BOLT
TTL2060
Spare: 2

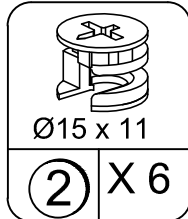

Ø15 x 11

② X 6

CAM LOCK
TTL6025
Spare:1

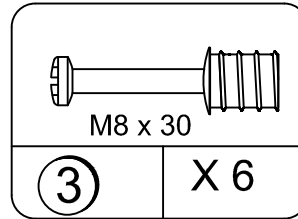

M8 x 30

③ X 6

CAM BOLT
TTL6026
Spare:1

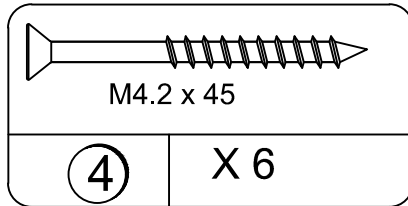

M4.2 x 45

④ X 6

SCREW
TTL1079
Spare:1

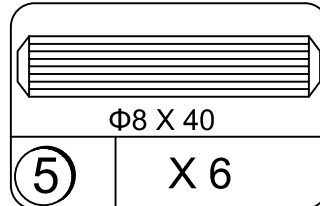

Ø8 X 40

⑤ X 6

WOOD DOWEL
TTL4005
Spare:1

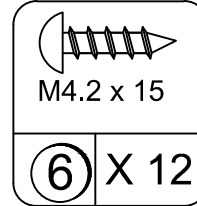

M4.2 x 15

⑥ X 12

SCREW
TTL1009
Spare:2

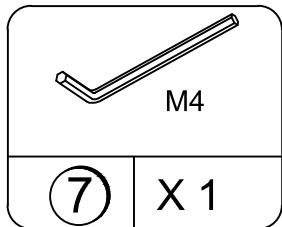

M4

⑦ X 1

HEX KEY
TTL5015



**WARNING
ADVERTENCIA**

WARNING LABEL
TTL1748

This illustration shows how the CAM fastening system works.

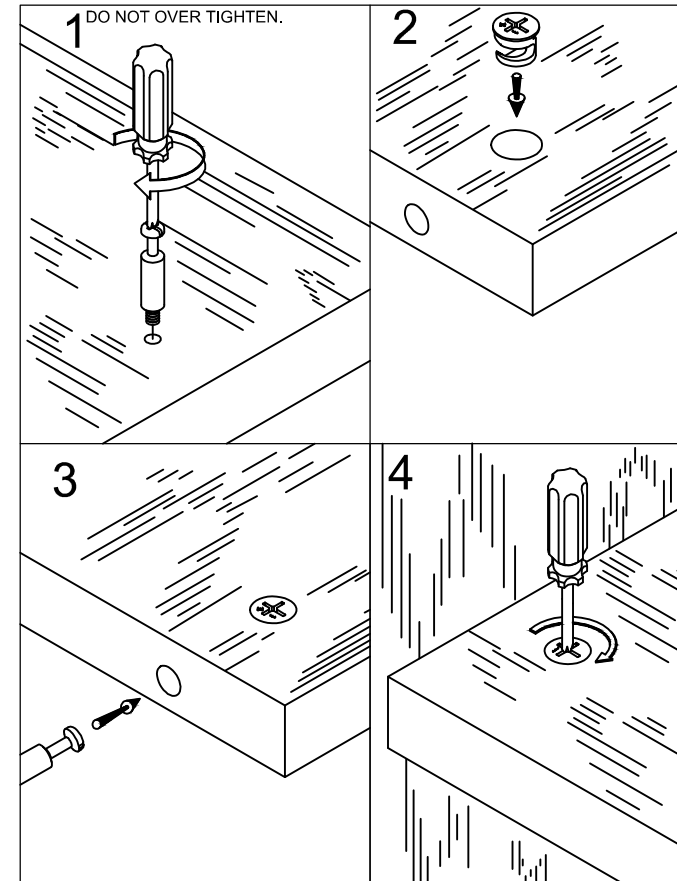

1

- Screw six cam bolts (3) into the holes of top (A) as below shown.
- Insert three wood dowel (5) into the holes of top (A) as below shown.

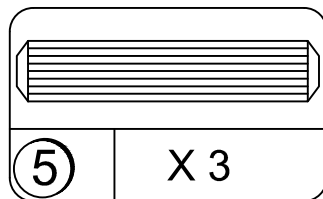
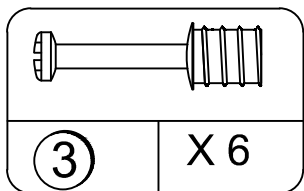
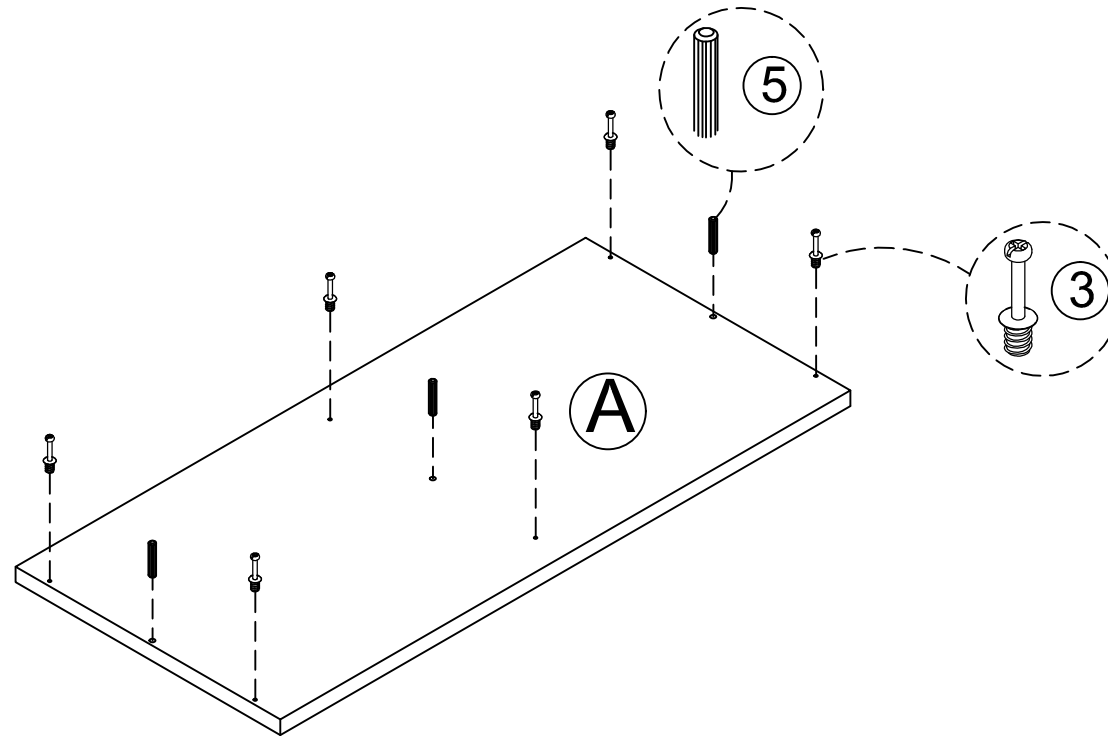

2

- Attach panels (D&E&F) to top (A) with six cam locks (2) as below shown.
- Insert three wood dowel (5) into the holes of panels (D&E&F) as below shown.

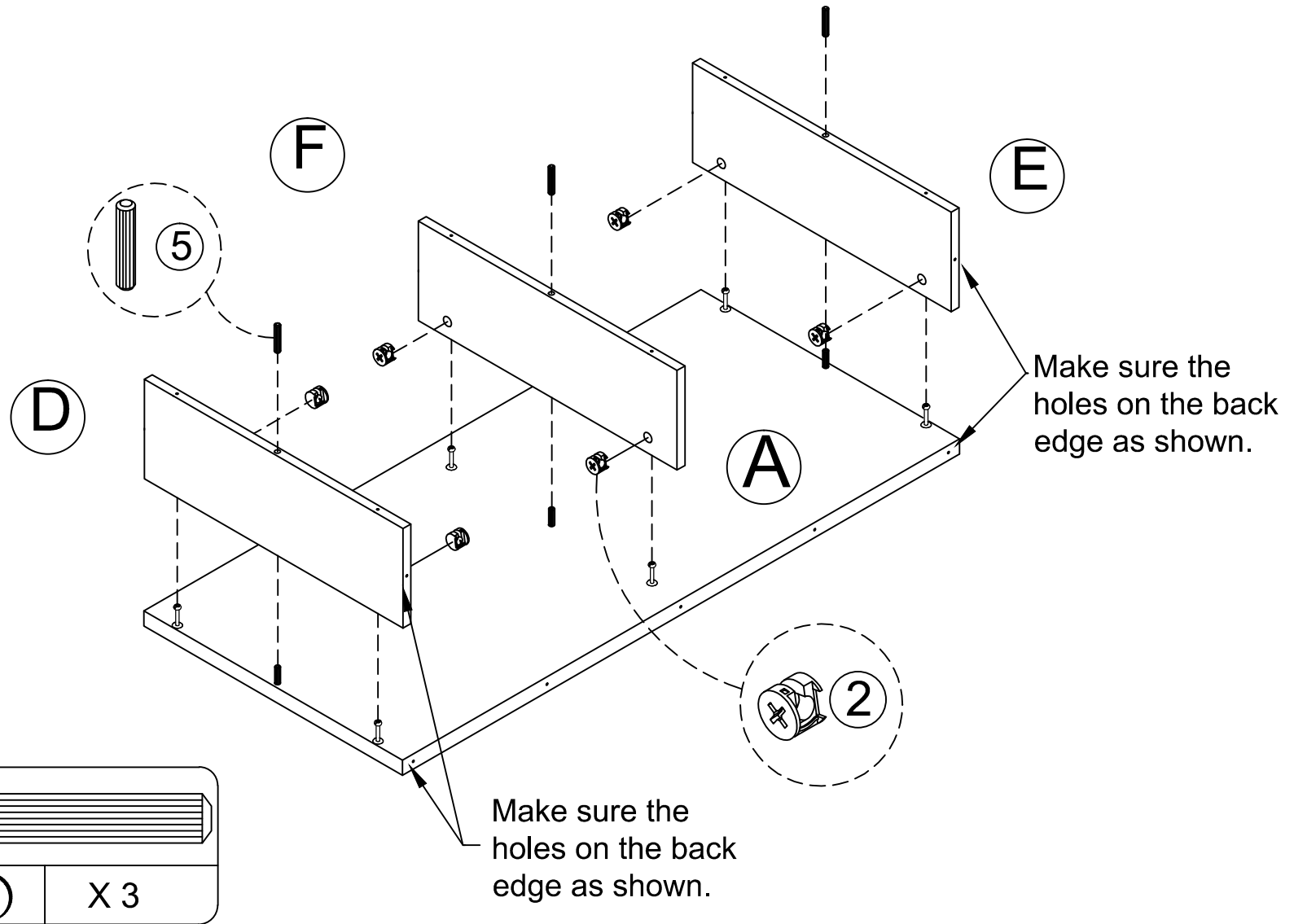

3

- Attach bottom (B) to assembled unit with six screws (4) as below shown.

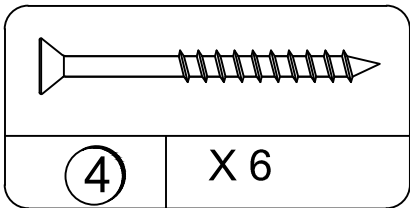
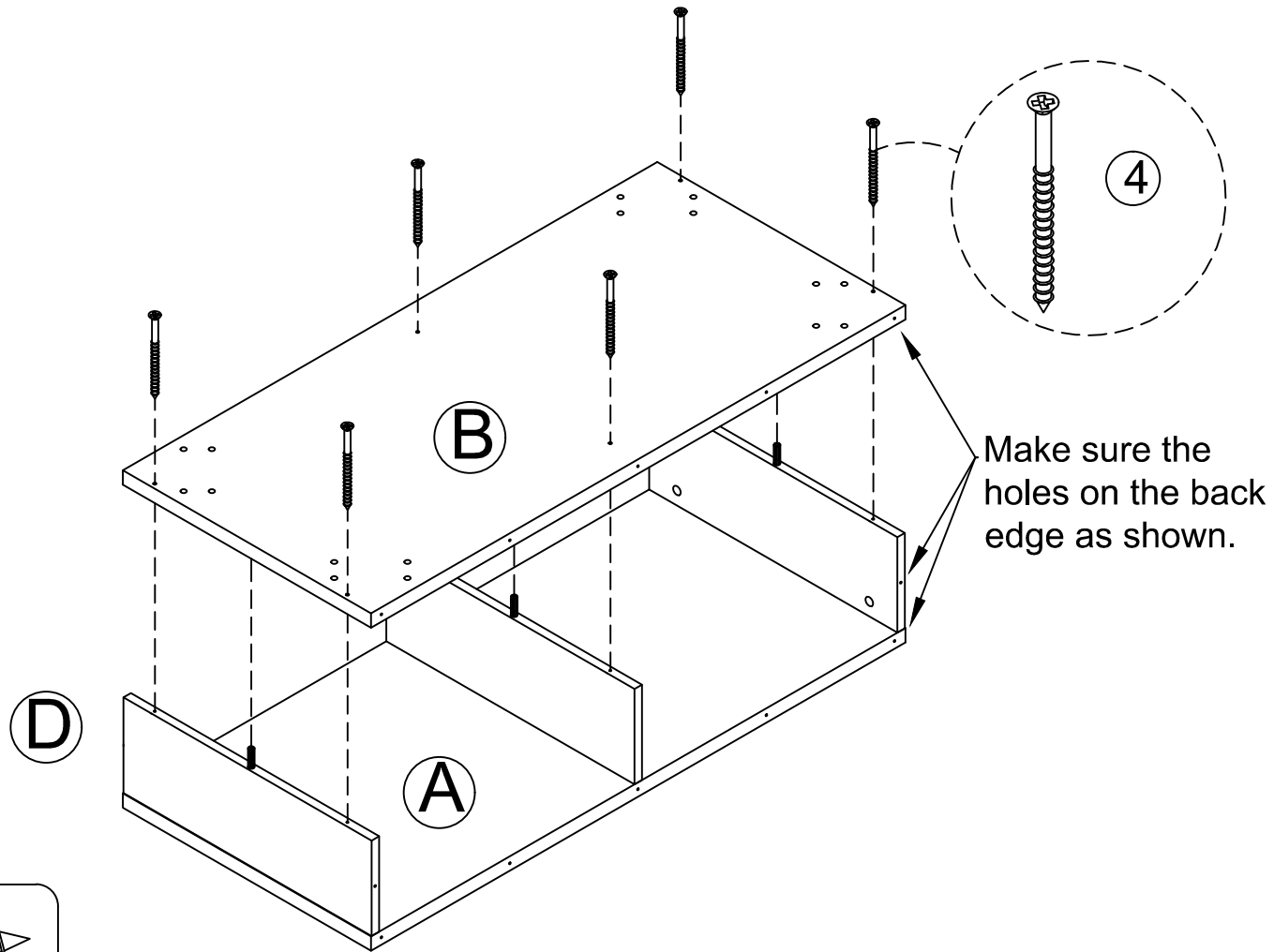

4

- Attach back panel (C) to assembled unit with twelve screws (6) as below shown.

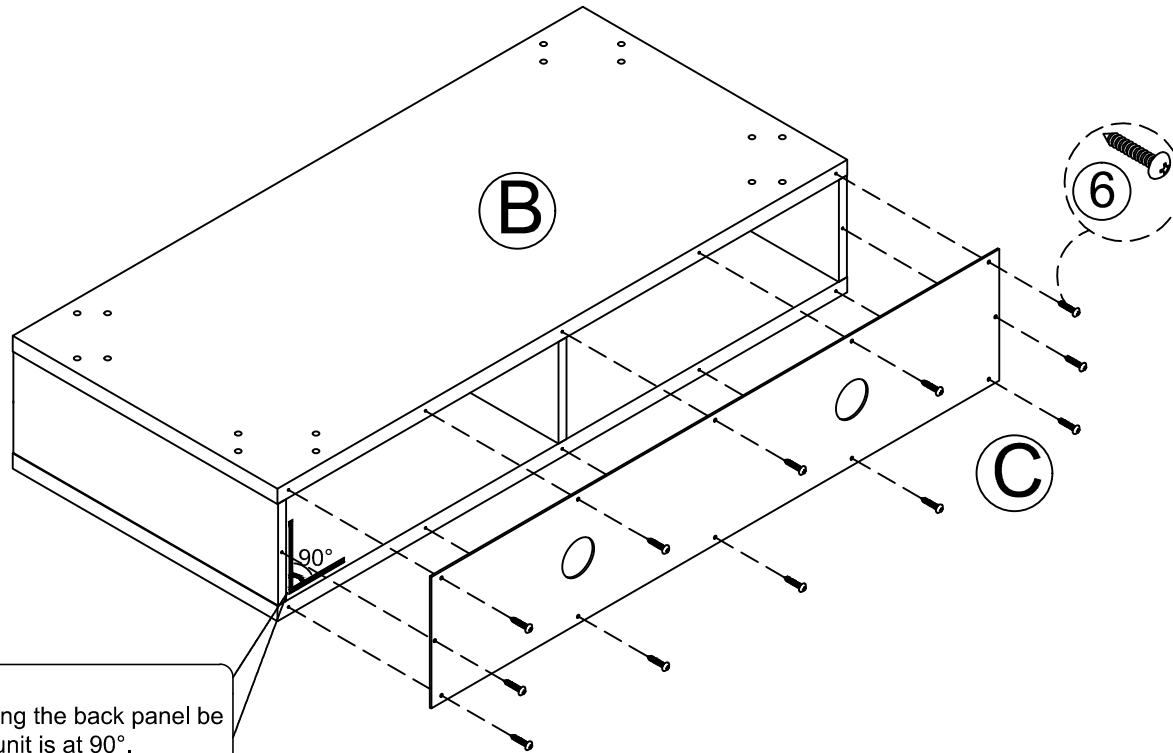

Before attaching the back panel be sure that the unit is at 90°.

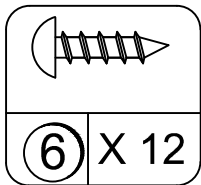

5 - Attach four legs (G) to assembled unit with sixteen bolts (1) as below shown.

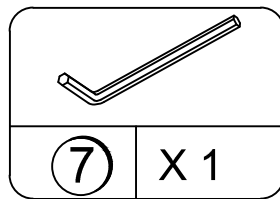
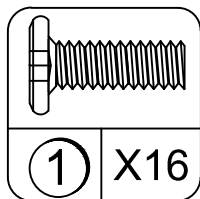
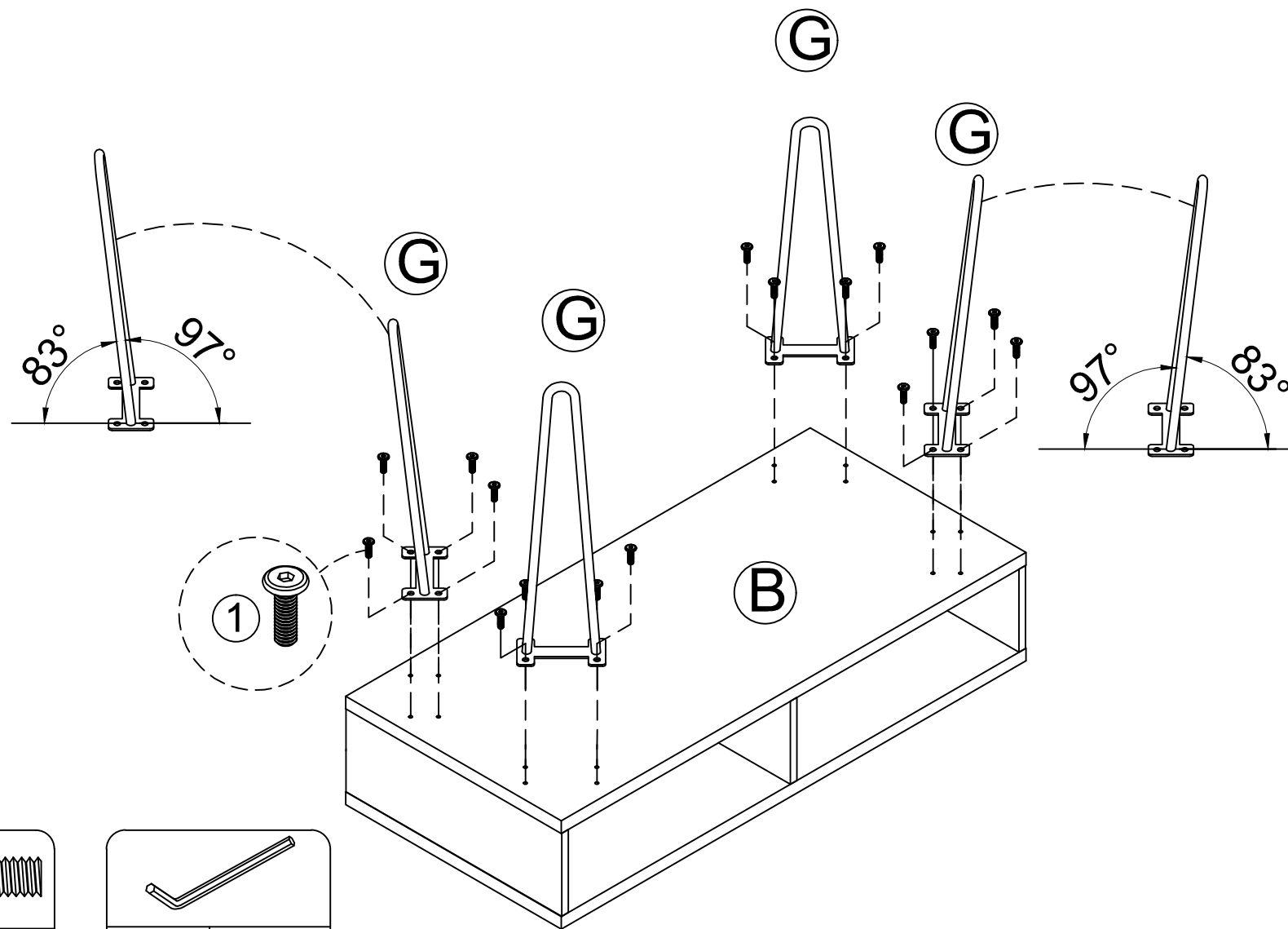

Call our toll free number for any assistance you should need or visit our website

WEIGHT LIMITS:

Clean the product with your favorite furniture polish and a soft cloth. Do not use harsh chemicals or abrasive cleaners.

Before moving the unit, remove everything including TV from the unit. Move your new furniture carefully with two people. Lift and carry the unit. Never push or drag the unit.

Do not allow children to climb or play on the unit. Failure to comply could result in severe injury.

This unit has been designed to support the maximum loads shown. Exceeding these load limits could cause unit sagging, instability, product collapse and/or serious injury.

Apply the warning label to the TV stand as shown, be sure the TV covers the label in use. You will not be able to remove the label after it is applied to the TV stand.

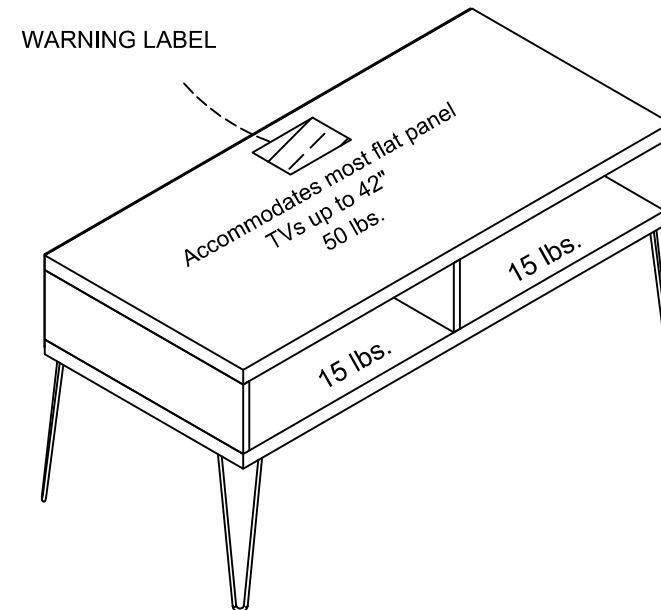

Enjoy Your Furniture