









PART IDENTIFICATION	QUANTITY PER SET	PART IDENTIFICATION	QUANTITY PER SET
A: 	1	D: 	4
B: 	1	E: 	1
C: 	4		

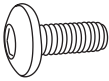
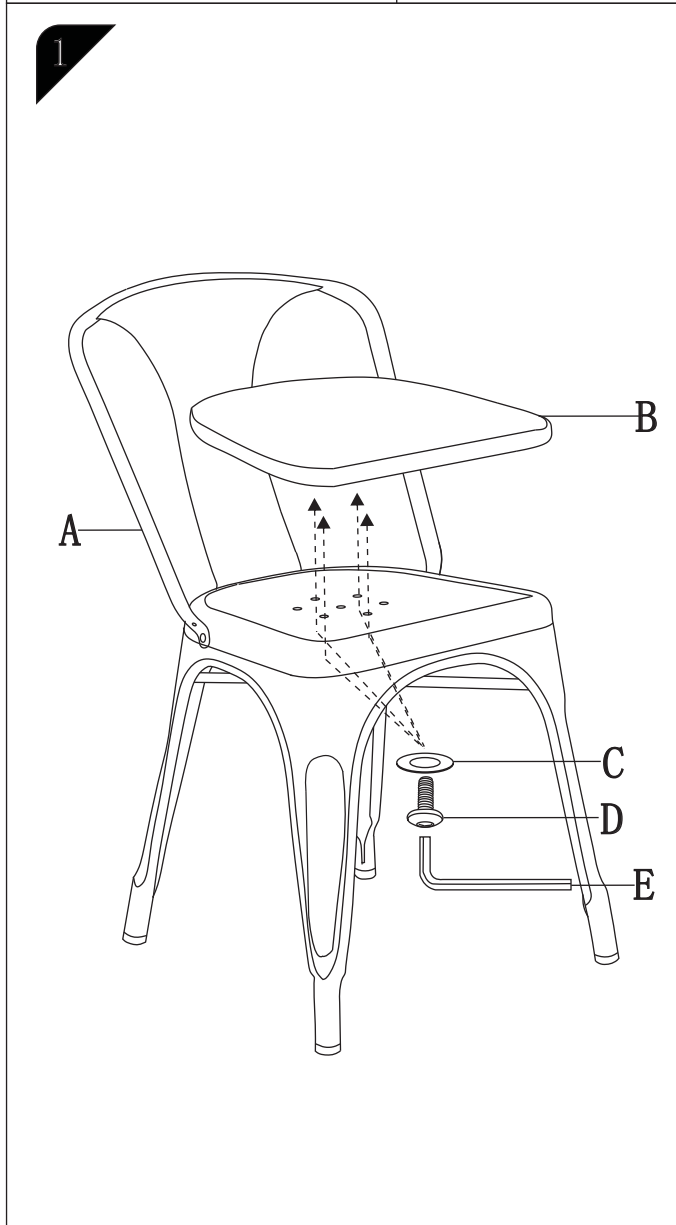
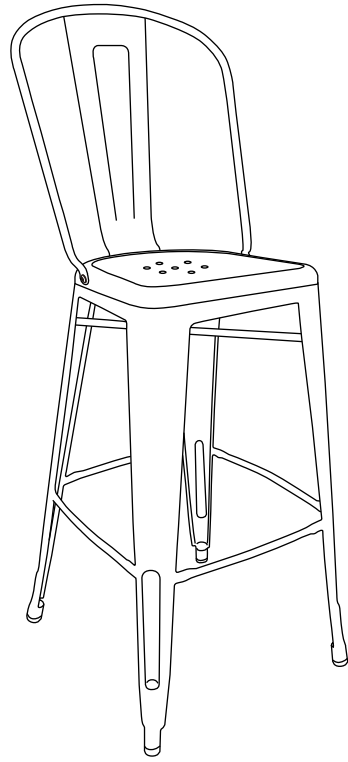

Assembly Instruction Sheet

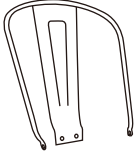
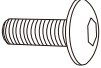

CAUTION: Because of the edges of some parts before assembly may be sharp, please handle unassembled parts carefully.

Parts List	Qty
A 	1
B 	1
C 	4
D 	1

1

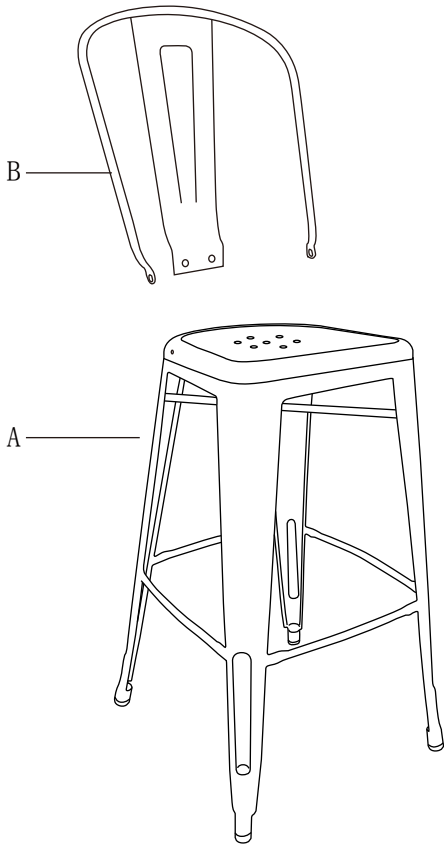

2

