

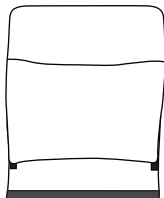
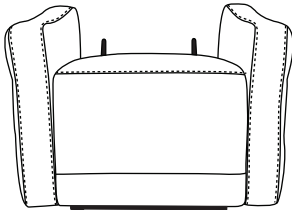

## ASSEMBLY INSTRUCTION POWER LAY FLAT RECLINING CHAIR

**NOTE: Do not use power tools for assembly. Power tools increase the risk of over tightening which leads to splitting or cracking the wood.**

### PART LIST

NO.	DRAWING	QTY	DESCRIPTION
<b>A</b>		<b>1 PC</b>	<b>BACK REST</b>
<b>B</b>		<b>1 PC</b>	<b>SEAT WITH HEADREST WIRE</b>

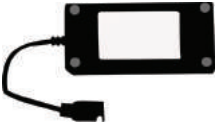
### HARDWARE LIST

NO.	DRAWING	QTY	DESCRIPTION
<b>1</b>		<b>1 PC</b>	<b>ADAPTOR</b>
<b>2</b>		<b>1 PC</b>	<b>PLUG WITH WIRE</b>

**STEP#1**

Align the female brackets at the back rest onto the male brackets at the seat, insert back rest to the seat then push to the end and make sure it is fixed in position securely. Connecting the wire from back rest to seat for power headrest.

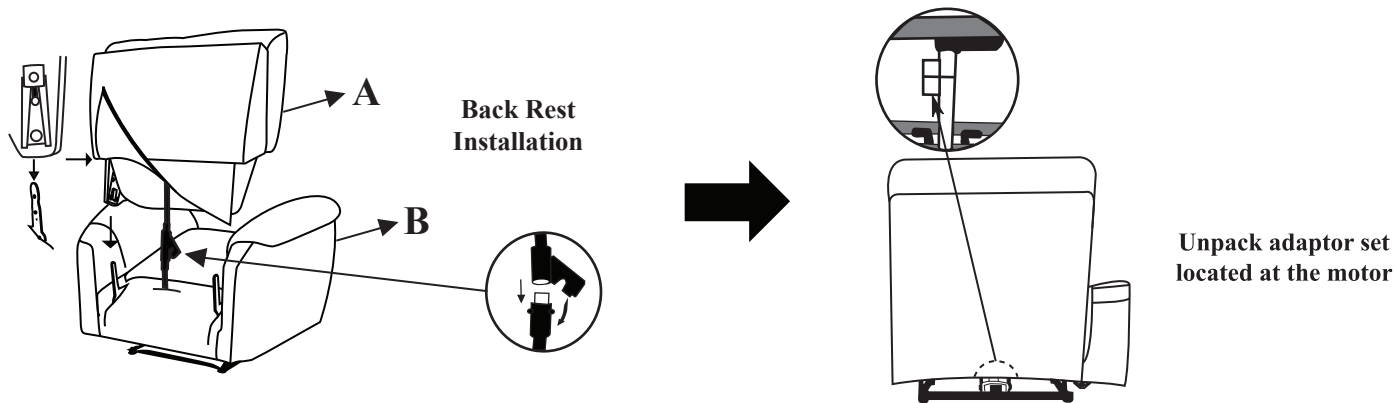

**STEP#2**

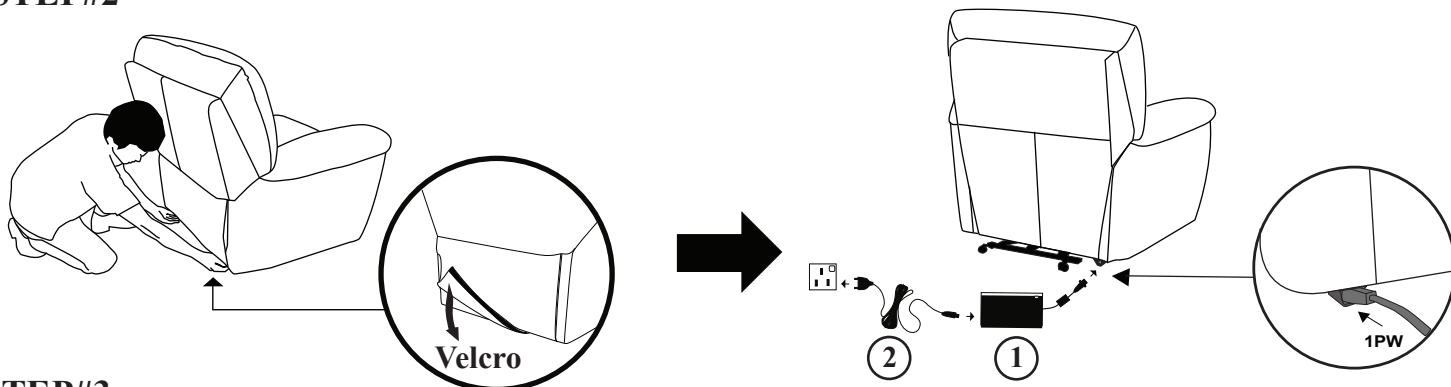

**STEP#3**

Slowly pull the zipper after assembly.

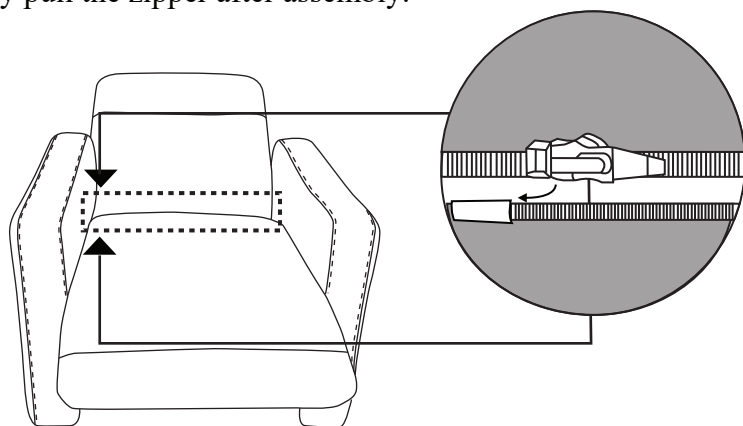

**STEP#4**

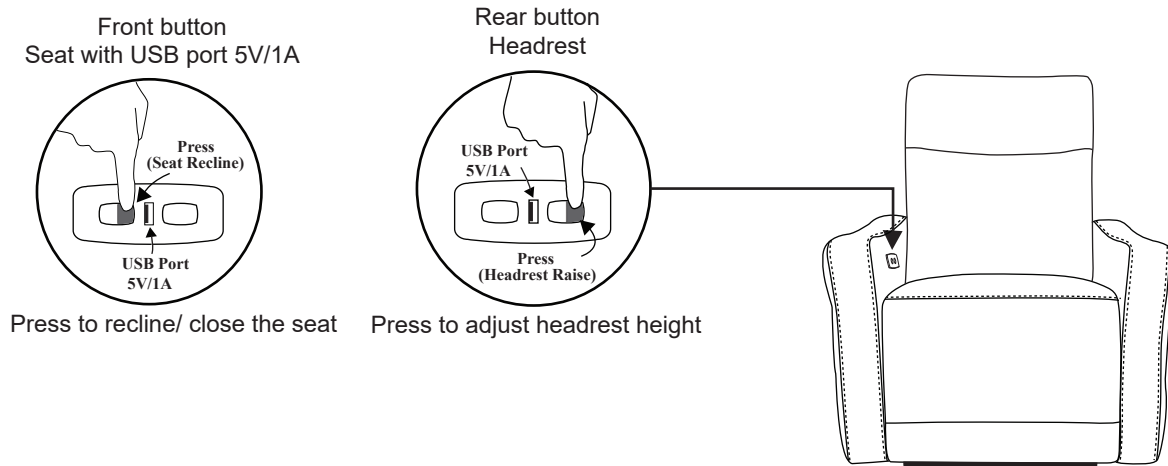

**CARE INSTRUCTION FOR FABRIC:**

**In order to maintain the original appearance of your fabric furniture, please follow below simple care procedure :**

- Avoid exposing furniture directly to sunlight or heating and air conditioning outlets. Exposure to sunlight or heating and air conditioning outlets will fade/damage fabric.
- Wipe gently with a damp soft cloth to remove dust, dirt and any grime build up.



- Disconnect the electrical plug from the wall outlet before cleaning, moving, servicing or when not in use for an extended period of time.
- Plug directly into a wall outlet. Do not use an extension cord or adaptor.
- Check the condition of the power transformers, electrical cords, plugs and connectors monthly. Keep the power adaptor and electrical cords away from heat sources. Never operate the unit with a damaged power adaptor, electrical cord, plug or connector.
- Before moving the product, please disconnect the electrical plug from the wall outlet and secure the mechanism to prevent unexpected opening or movement. Never move the product by the mechanism, legrest, handle, or reclining back.
- Do not attempt to disassemble or service the adaptor or motor. No serviceable parts are inside.
- Do not allow electrical cord to be pinched between moving parts or between the frame and the floor. Do not place cord under carpet or in location where it could become worn.
- Unplug the power cord immediately if you detect strange odors or fumes coming from the chair.

**PLEASE KEEP ASSEMBLY INSTRUCTION FOR FUTURE REFERENCE**

## ASSEMBLY INSTRUCTION



### POWER DOUBLE LAY FLAT RECLINING LOVE SEAT

**NOTE: Do not use power tools for assembly. Power tools increase the risk of over tightening which leads to splitting or cracking the wood.**

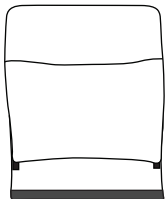
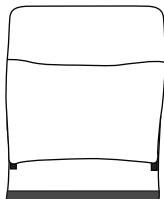
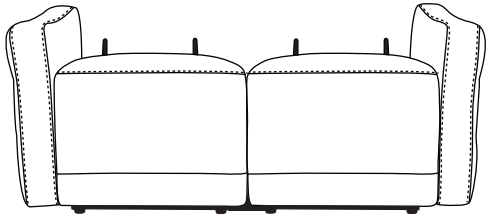
#### PART LIST

NO.	DRAWING	QTY	DESCRIPTION
<b>A</b>		<b>1 PC</b>	<b>LSF BACK REST</b>
<b>B</b>		<b>1 PC</b>	<b>RSF BACK REST</b>
<b>C</b>		<b>1 PC</b>	<b>SEAT WITH HEADREST WIRE</b>

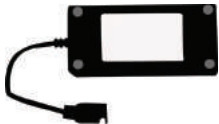
#### HARDWARE LIST

NO.	DRAWING	QTY	DESCRIPTION
<b>1</b>		<b>1 PC</b>	<b>ADAPTOR</b>
<b>2</b>		<b>1 PC</b>	<b>PLUG WITH WIRE</b>
<b>3</b>		<b>1 PC</b>	<b>Y-CABLE</b>

### STEP#1

Align the female brackets at the back rest onto the male brackets at the seat, insert back rest to the seat then push to the end and make sure it is fixed in position securely. Connecting the wire from back rest to seat for power headrest.

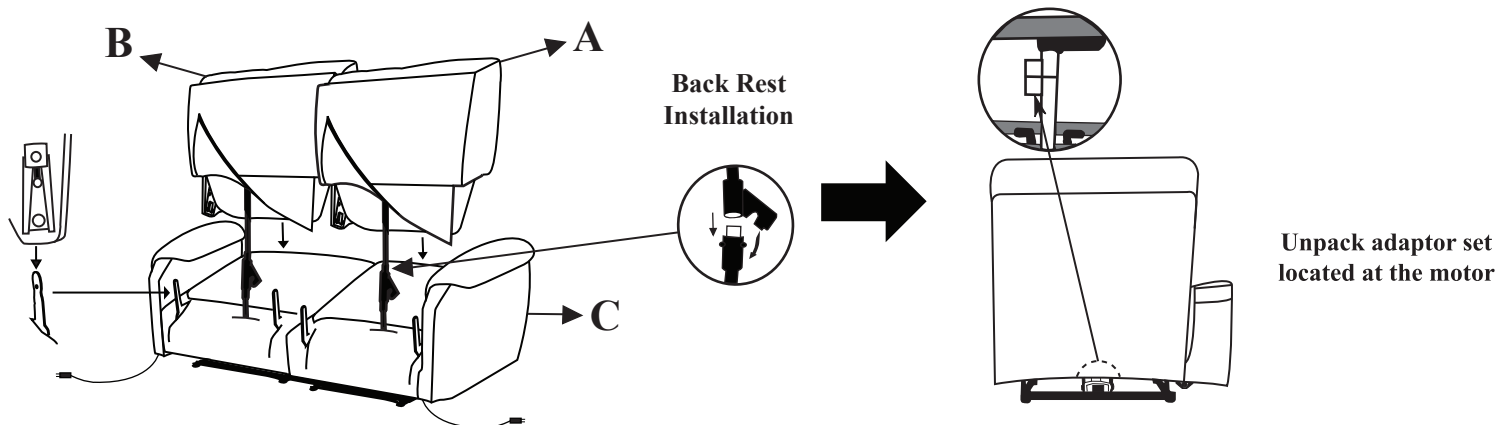

### STEP#2

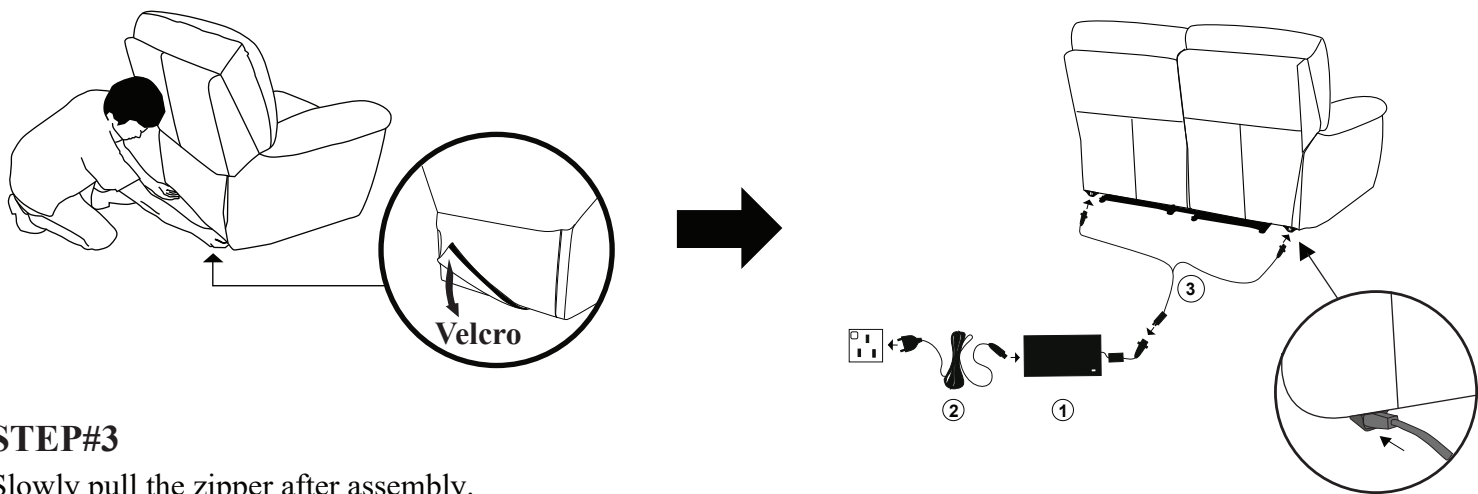

### STEP#3

Slowly pull the zipper after assembly.

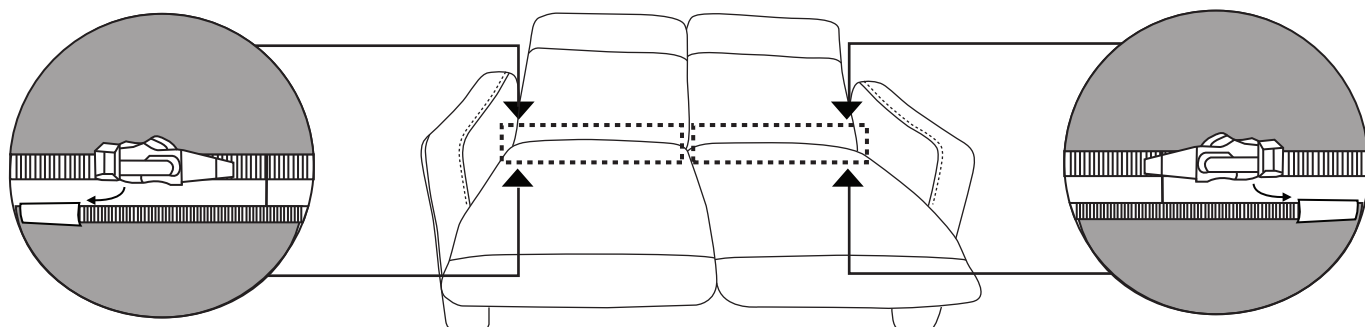

### STEP#4

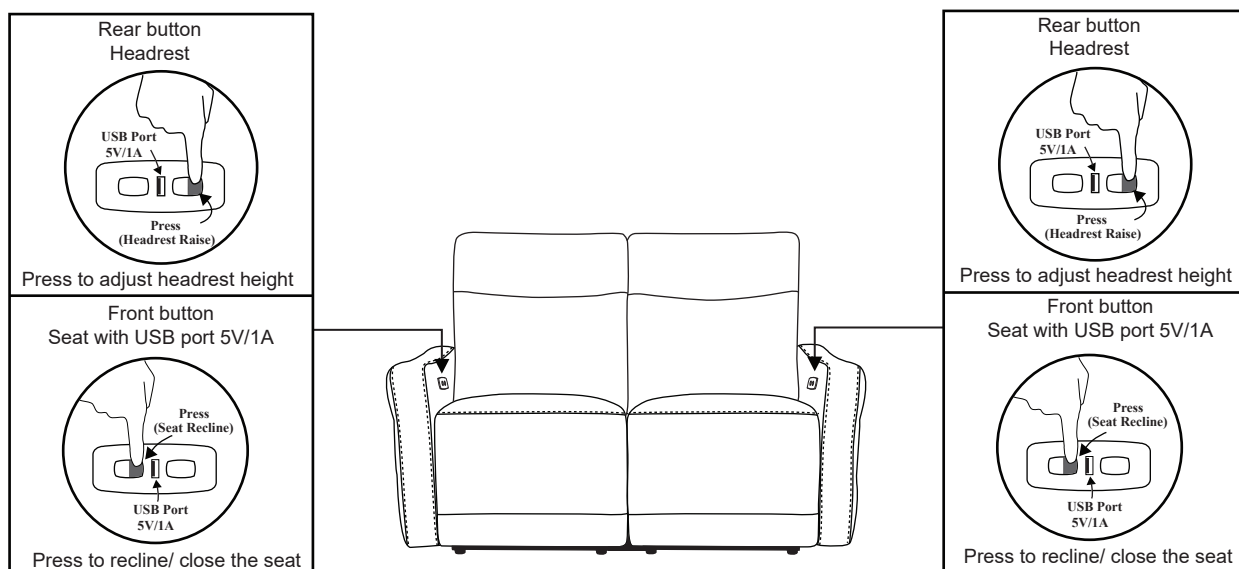

**CARE INSTRUCTION FOR FABRIC:**

**In order to maintain the original appearance of your fabric furniture, please follow below simple care procedure :**

- Avoid exposing furniture directly to sunlight or heating and air conditioning outlets. Exposure to sunlight or heating and air conditioning outlets will fade/damage fabric.
- Wipe gently with a damp soft cloth to remove dust, dirt and any grime build up.



- Disconnect the electrical plug from the wall outlet before cleaning, moving, servicing or when not in use for an extended period of time.
- Plug directly into a wall outlet. Do not use an extension cord or adaptor.
- Check the condition of the power transformers, electrical cords, plugs and connectors monthly. Keep the power adaptor and electrical cords away from heat sources. Never operate the unit with a damaged power adaptor, electrical cord, plug or connector.
- Before moving the product, please disconnect the electrical plug from the wall outlet and secure the mechanism to prevent unexpected opening or movement. Never move the product by the mechanism, legrest, handle, or reclining back.
- Do not attempt to disassemble or service the adaptor or motor. No serviceable parts are inside.
- Do not allow electrical cord to be pinched between moving parts or between the frame and the floor. Do not place cord under carpet or in location where it could become worn.
- Unplug the power cord immediately if you detect strange odors or fumes coming from the chair.

**PLEASE KEEP ASSEMBLY INSTRUCTION FOR FUTURE REFERENCE**

## ASSEMBLY INSTRUCTION



### POWER DOUBLE LAY FLAT RECLINING SOFA

**NOTE: Do not use power tools for assembly. Power tools increase the risk of over tightening which leads to splitting or cracking the wood.**

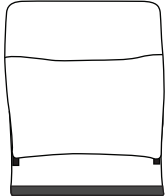
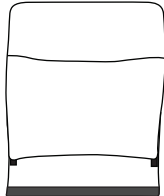
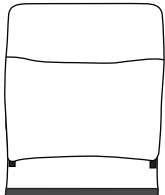
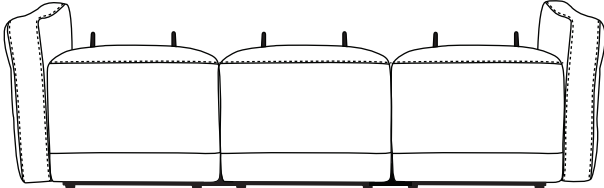
#### PART LIST

NO.	DRAWING	QTY	DESCRIPTION
<b>A</b>		<b>1 PC</b>	<b>LSF BACK REST</b>
<b>B</b>		<b>1 PC</b>	<b>RSF BACK REST</b>
<b>C</b>		<b>1 PC</b>	<b>MIDDLE BACK REST</b>
<b>D</b>		<b>1 PC</b>	<b>SEAT WITH HEADREST WIRE</b>

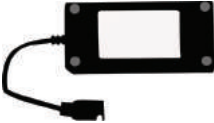
#### HARDWARE LIST

NO.	DRAWING	QTY	DESCRIPTION
<b>1</b>		<b>1 PC</b>	<b>ADAPTOR</b>
<b>2</b>		<b>1 PC</b>	<b>PLUG WITH WIRE</b>
<b>3</b>		<b>1 PC</b>	<b>Y-CABLE</b>

### STEP#1

Align the female brackets at the back rest onto the male brackets at the seat, insert back rest to the seat then push to the end and make sure it is fixed in position securely. Connecting the wire from back rest to seat for power headrest.

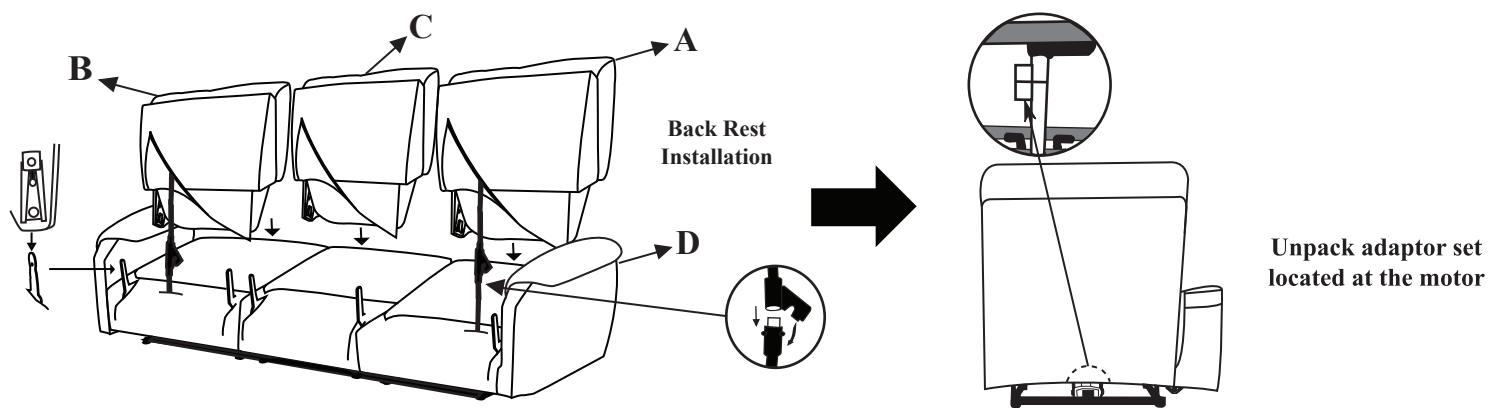

### STEP#2

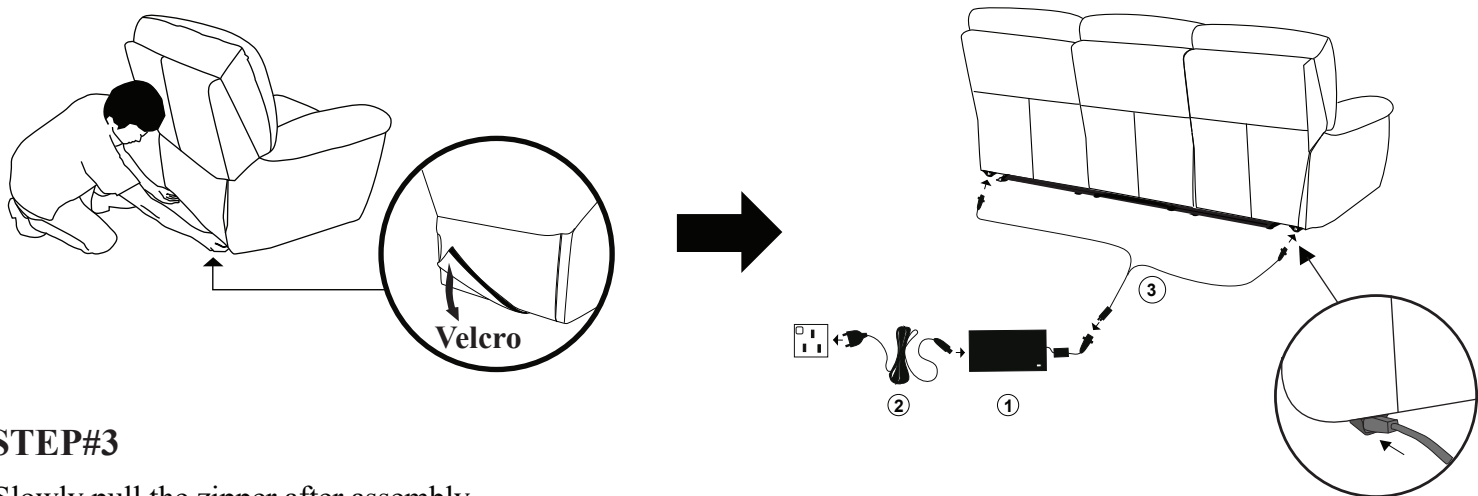

### STEP#3

Slowly pull the zipper after assembly.

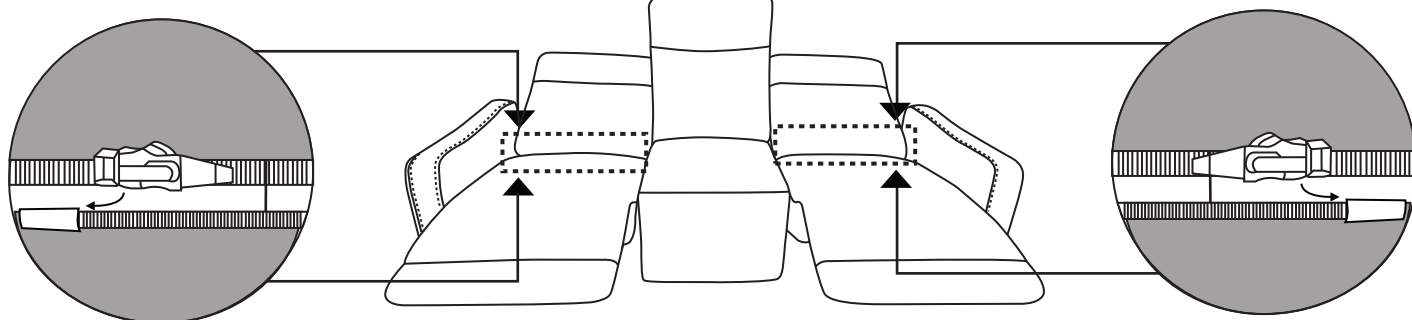

### STEP#4

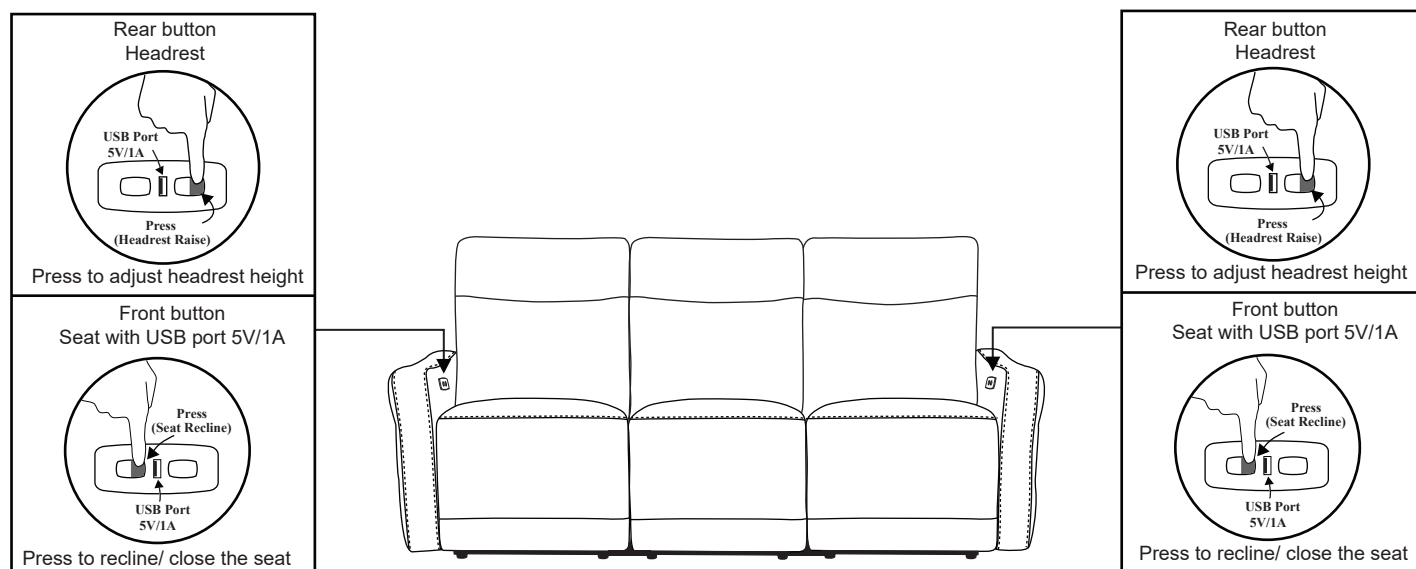

**CARE INSTRUCTION FOR FABRIC:**

**In order to maintain the original appearance of your fabric furniture, please follow below simple care procedure :**

- Avoid exposing furniture directly to sunlight or heating and air conditioning outlets. Exposure to sunlight or heating and air conditioning outlets will fade/damage fabric.
- Wipe gently with a damp soft cloth to remove dust, dirt and any grime build up.



- Disconnect the electrical plug from the wall outlet before cleaning, moving, servicing or when not in use for an extended period of time.
- Plug directly into a wall outlet. Do not use an extension cord or adaptor.
- Check the condition of the power transformers, electrical cords, plugs and connectors monthly. Keep the power adaptor and electrical cords away from heat sources. Never operate the unit with a damaged power adaptor, electrical cord, plug or connector.
- Before moving the product, please disconnect the electrical plug from the wall outlet and secure the mechanism to prevent unexpected opening or movement. Never move the product by the mechanism, legrest, handle, or reclining back.
- Do not attempt to disassemble or service the adaptor or motor. No serviceable parts are inside.
- Do not allow electrical cord to be pinched between moving parts or between the frame and the floor. Do not place cord under carpet or in location where it could become worn.
- Unplug the power cord immediately if you detect strange odors or fumes coming from the chair.

**PLEASE KEEP ASSEMBLY INSTRUCTION FOR FUTURE REFERENCE**