

WARRANTY

We strive to offer high-quality products, and we also try our best to satisfy each and every customer that orders from us with product or service as needed. We provide 30 days warranty starting from the time you receive the item. Each customer must provide a record of their order such as the order number, or item receipt for any items that are out of the warranty period you may also still receive replacement parts by purchasing them with our company if they are available.

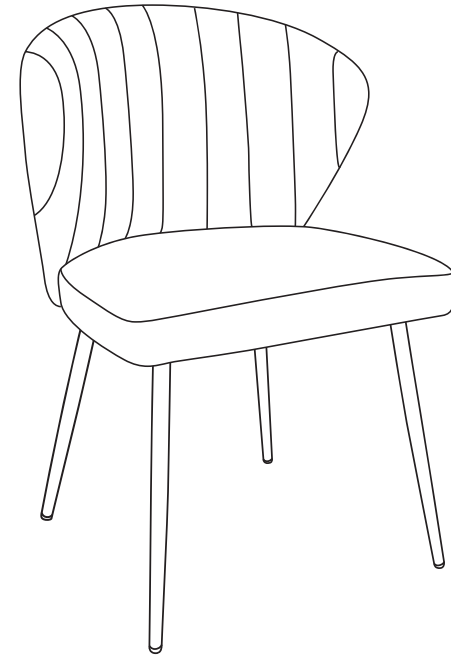

NOTE:

This brochure contains IMPORTANT safety info. Please read and keep for future reference.

MAINTAINANCE AND WARNING

- Keep furniture away from heat.
- Do not clean furniture with harsh cleansers or polish. Do not use detergents, Solvents, abrasives, spray packs or leather cleaner. Use non-color mild soap with warm water clean spills(Mix 1:10 soap to water)
- Do not place furniture under direct sunlight, material will possibly fade over time.
- Do not use on site dry Cleaning machine.
- Children should not climb or jump on the furniture.
- Do not write on furniture without a padded barrier to protect the surface.
- Not for commercial use, For residential use only.



Weight Limitation

250LBS

PARTS LIST

Ax1
Seat

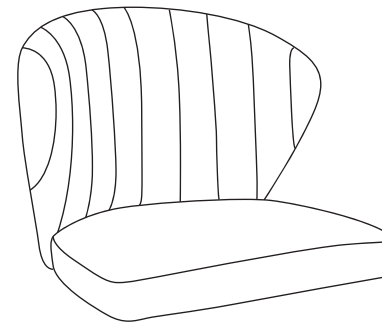

Bx1
Up foot

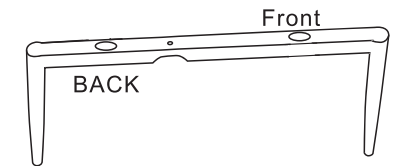

Cx1
Down foot

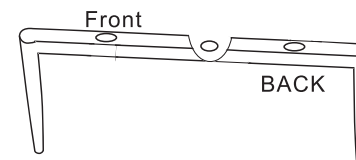

HARDWARE LIST

Ex1
M6x30mm
Screw



Fx4
M6x50mm
Screw



Gx5
Gaskets



Hx5
Gasket clasp



lx1
M6
Spanner

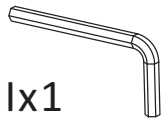

SPARE

Ex1
M6x30mm
Screw



Fx4
M6x50mm
Screw



Gx5
Gaskets



Hx5
Gasket clasp



Kx1
Gasket clasp



Be sure to check all packing material carefully for small parts, which may have come loose inside the carton during shipment.

ASSEMBLY INSTRUCTIONS

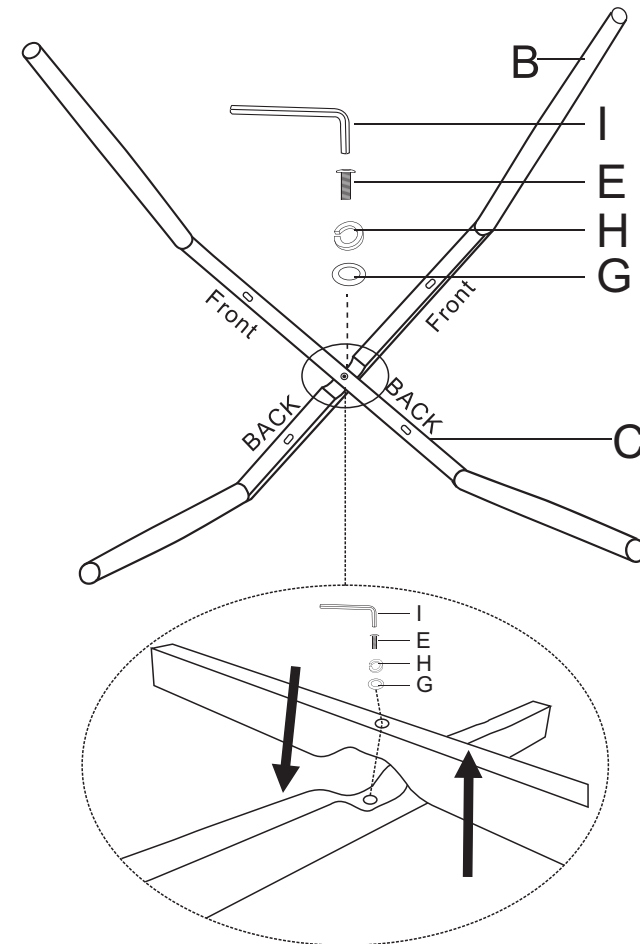

STEP 1: Use bolt E, spring washer H, flat washer G, allen wrench I to connect metal leg part B and C together, don't fasten the bolt at this stage.

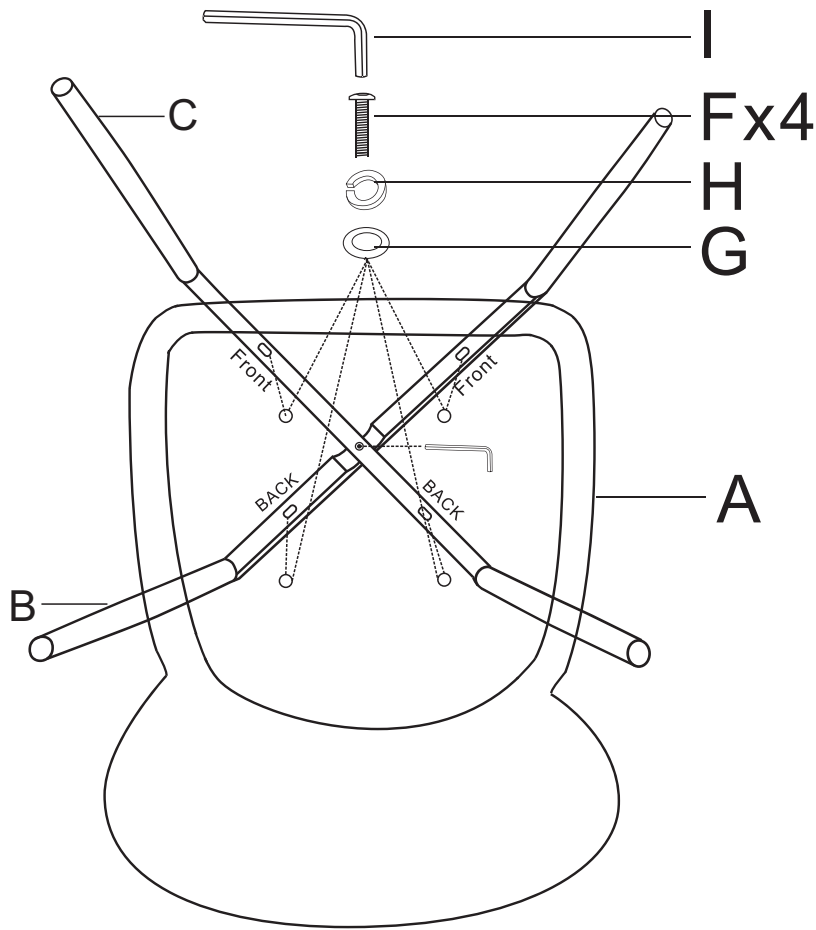

Place the chair seat/back assembly on clean padded surface.

STEP 2: Use wrench I ,Bolt F, Spring Washer H, flat Washer G to connect the back hole of the outrigger to the bottom of the seat. Make sure all holes on legs align with holes on bottom of seat then fasten all bolts to secure.

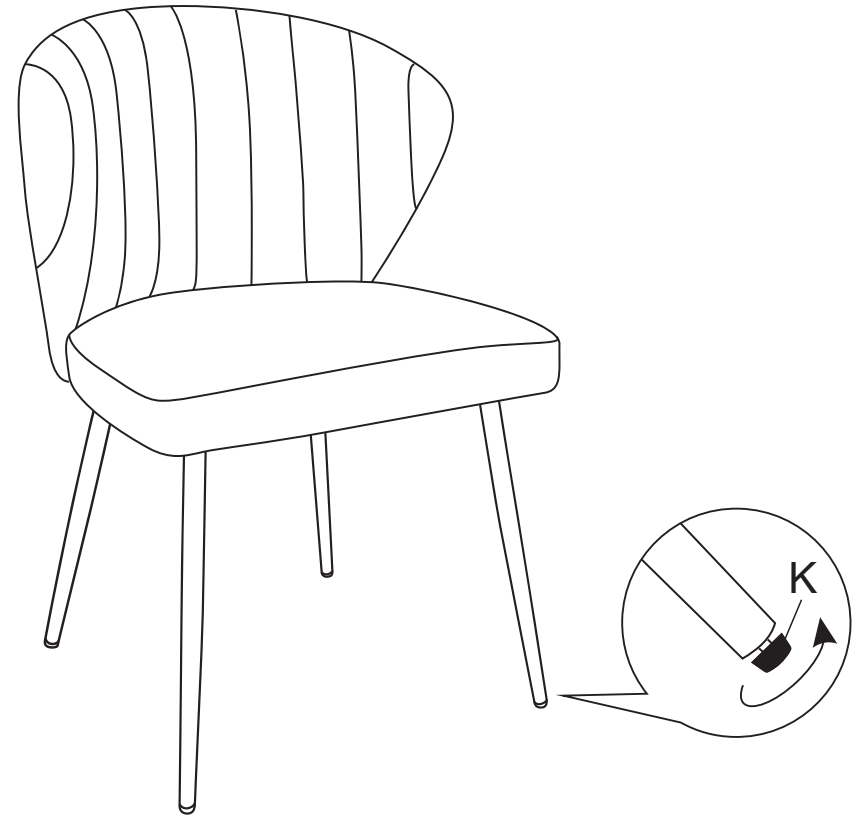

Adjust levelers under legs to set the seat level.

STEP 3 :Assembly completed.

Please pay attention to the length of screws during Installation. Incorrect use of screws will lead to Instability or failure to Install.

