



WARNING!!

NEVER allow children to climb or hang on furniture, including drawers or cabinet doors.

In addition to installing the restrains, to help prevent tip-over

- 1. For use with televisions weighing 58.2 lbs or fewer. Use with heavier televisions may result in instability causing tip-over resulting in death or serious injury. NEVER use with CRT televisions**

- 2. Do not stand on the product**

 WARNING	
	<p>Children have died from furniture tipover. To reduce the risk of furniture tipover:</p> <ul style="list-style-type: none">• ALWAYS install tipover restraint provided.• For use with televisions weighing 58.2 lbs or fewer. Use with heavier televisions may result in instability causing tipover resulting in death or serious injury. NEVER use with CRT TVs.• NEVER allow children to stand, climb or hang on drawers, doors, or shelves.• NEVER open more than one drawer at a time.• Place heaviest items in the lowest drawers.• Do not defeat or remove the drawer interlock system.
	<p><i>This is a permanent label. Do not remove!</i></p>



Assembly Instructions



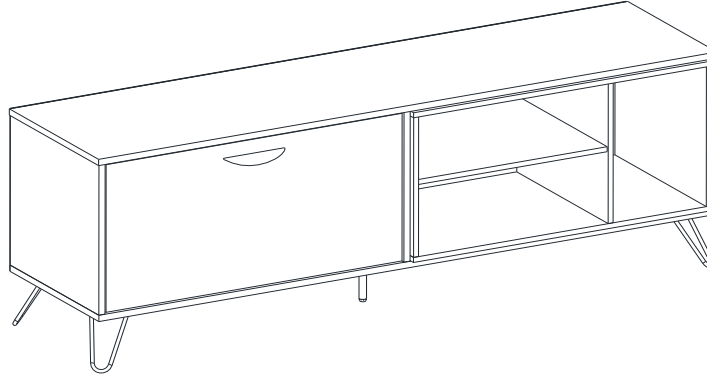

Caution : You must read this before you proceed





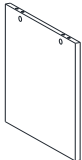
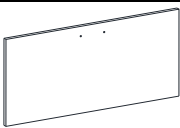
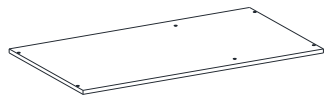
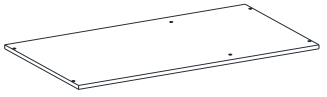
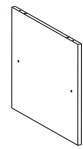
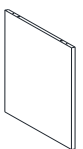

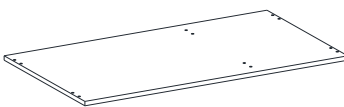



TV CABINET











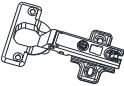
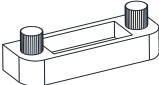
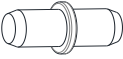



Parts List

Label	Picture	Description	QTY
A		Top Panel	1
B		Left Side Panel	1
C		Right Side Panel	1

D		Center Panel	1
E		Door Panel	1
F		Inner Top Panel	1
G		Inner Bottom Panel	1
H		Inner Side Left & Center Panel	2
I		Inner Side Right Panel	1
J		Shelf Panel	1
K		Back Panel	1
L		Bottom Panel	1
M		Handle	1
N		Leg	4

O		Middle Leg	1
Hardware			
Label	Picture	Description	QTY
①		Cam Lock	7
②		Cam Bolt	7
③		Cam Cap	7
④		Positioning Dowel (Ø8*30mm)	13
⑤		Positioning Dowel (Ø6*30mm)	13
⑥		Cap Wood Screw (M6*50mm)	7
⑦		Screw (M4*38mm)	13
⑧		Screw (M3.5*16mm)	34
⑨		Allen Key	1





⑩		Nail	26
⑪		Connector	2
⑫		Stopper	1
⑬		Shelf Support	5
⑭		Screw (M4*25mm)	5
⑮		Screwdriver (not provided)	1
⑯		Hammer (not provided)	1
⑰		Power Drill (not provided)	1

10" Air Press Pull Rod			
⑱		Ball Connector	1
⑲		Ball Connector Bracket	1
⑳		Shock Absorber	1
Cabinet Restraint Device Hardware			
㉑		Metal Bracket	4
㉒		Wall Plug	2
㉓		Wall Plug Screw	2
㉔		Pan Head Screw	2
㉕		Cabinet Restraint Strap	2

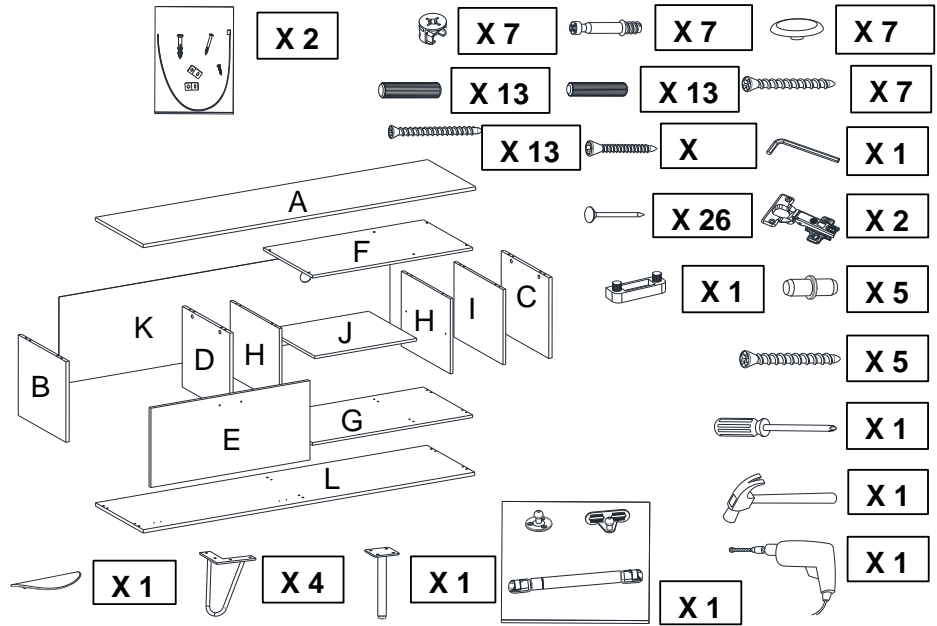
Assembly Preparation

Before Beginning Assembly:



-  • Read instructions, cover to cover-
-  • Have 2 adults on hand for assembly-
-  • Do not assemble on flooring or carpet-
-  • Assemble on a clean non-marring surface (packing foam)-
-  • Save all packaging until finished-

Assembly Steps

Overview

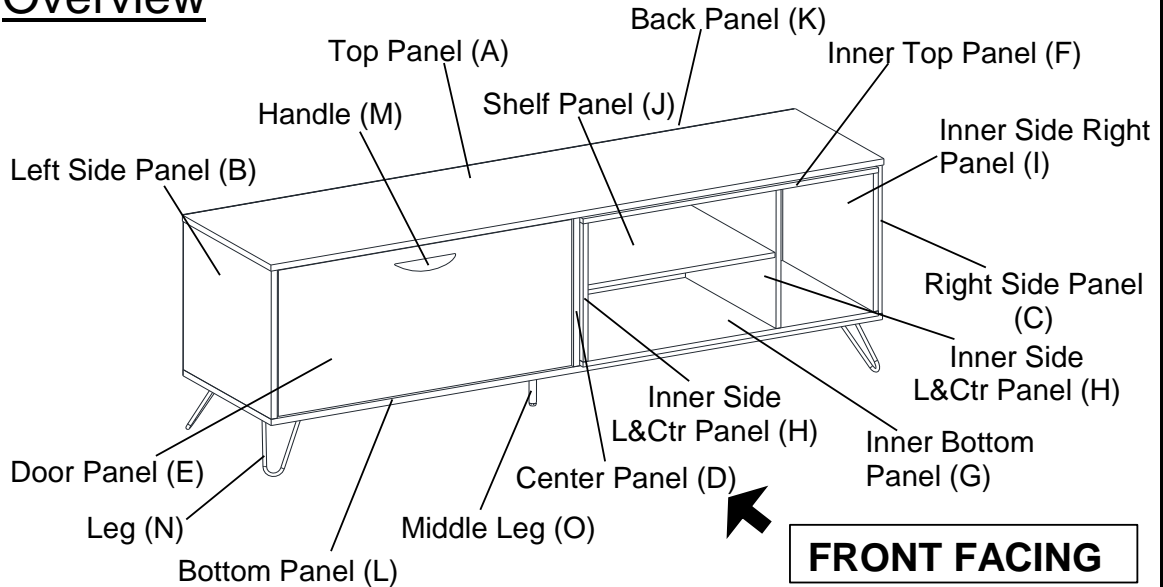

This TV Cabinet has multiple parts and may require up to 60 minutes to assemble. To give you an overview of the TV Cabinet parts, the above picture is to help you put the various parts into perspective. Please read through the instructions below to familiarise yourself with the parts and steps before assembly.

Step 1

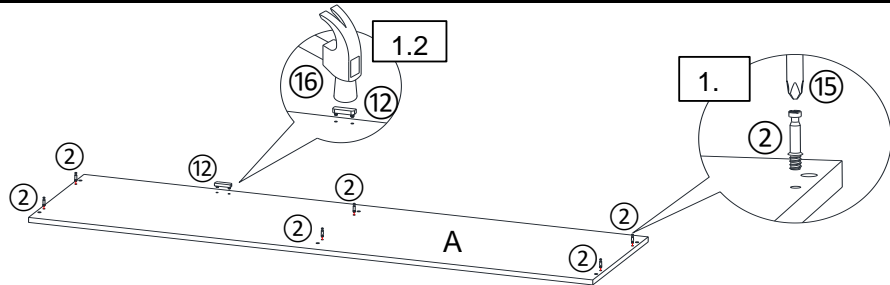

Unpack and place all parts on a clean, non-marring surface.

1.1) Attach Cam Bolts(②) to mounting positions on top surface of Top Panel(A) with Screwdriver(⑮).

1.2) Attach Stopper(⑫) to Top Panel(A) with Hammer(⑯).

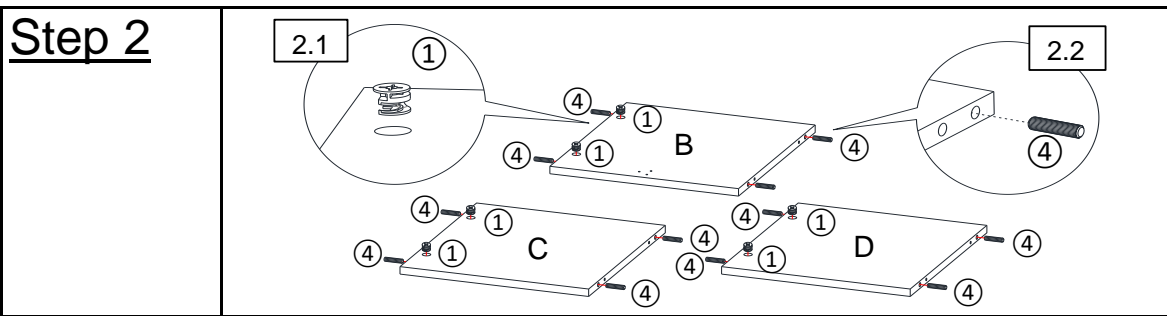

2.1) Insert Cam Locks(①) into mounting positions on Left Side Panel(B) by hand.

2.2) Insert Positioning Dowel(④) into mounting positions on Left Side Panel(B) by hand.

2.3) Repeat the same process on the Right Side Panel(C) and Center Panel(D).

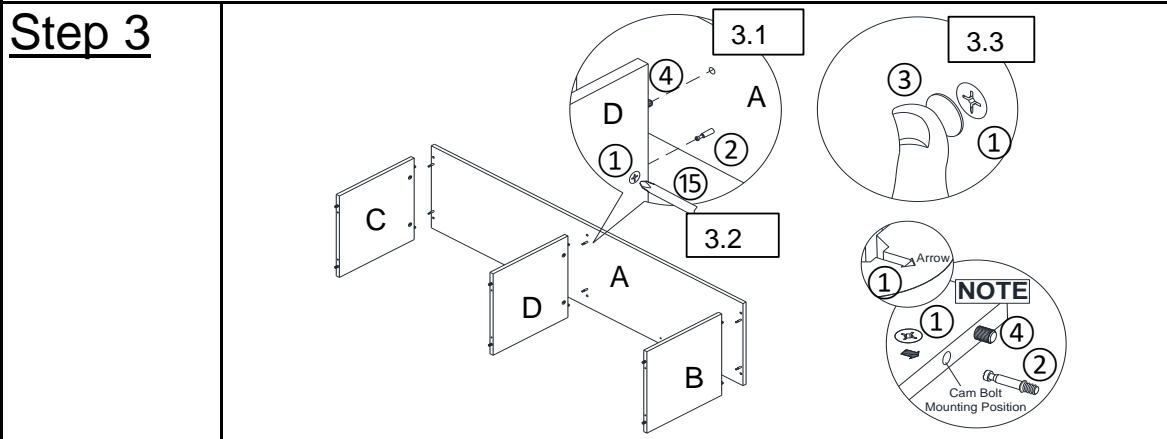

3.1) Insert Positioning Dowels(④) from Left Side Panel(B), Right Side Panel(C) and Center Panel(D) into mounting positions on Top Panel(A).

Note: Ensure the arrows on Cam Locks head points towards the Cam Bolt mounting positions.

3.1) Insert Cam Bolts(②) on Top Panel(A) into the mounting positions on Left Side Panel(B), Right Side Panel(C) and Center Panel(D).

3.2) Turn the Cam Locks(①) clockwise with the Screwdriver(⑮) until they all lock into place.

3.3) Insert Cam Cap(③) into Cam Lock(①) by hand.

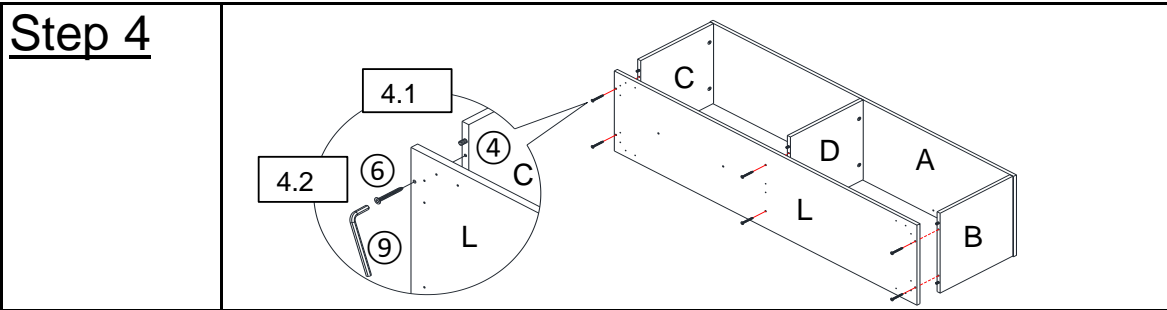

4.1) Insert Positioning Dowels(④) from Left Side Panel(B), Right Side Panel(C) and Center Panel(D) into mounting positions on Bottom Panel(L).
4.2) Attach Bottom Panel(L) to Left Side Panel(B) Right Side Panel(C) and Center Panel(D) using Cap Wood Screws(⑥) with Allen Key(⑨).

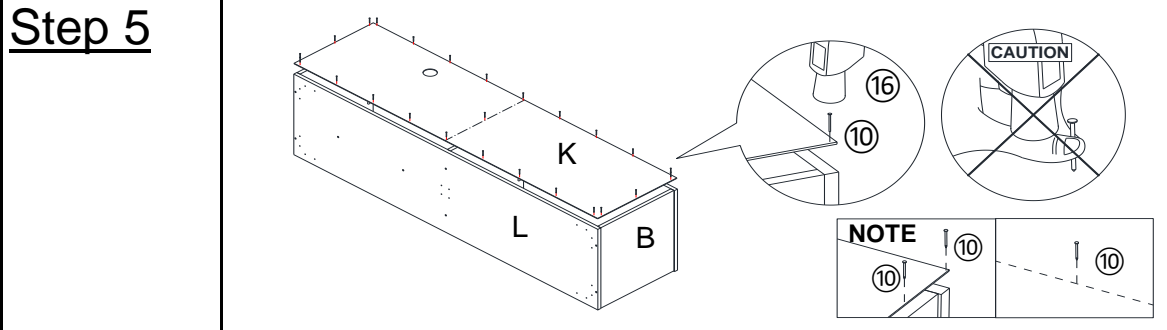

Attach Back Panel(K) to TV Cabinet Assembly using Nails(⑩) with Hammer(⑯).

Note: Ensure all the Cam Lock must be tighten after Attach the Back Panel(K).

Please be extra careful when using a hammer to avoid injury.

Note: Hit Nails along all four edges (slightly inwards from sides) on the lines drawn on the Back Panel(K).

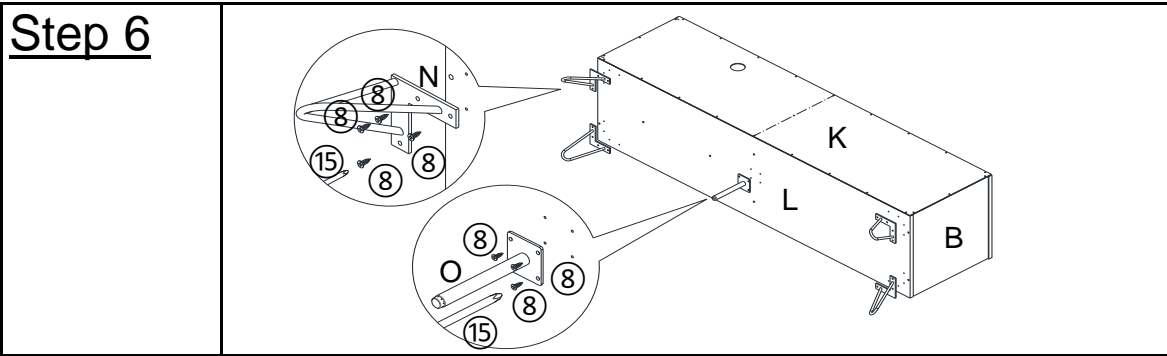

Attach Legs(N) and Middle Leg(O) to Bottom Panel(L) using Screws(8) with Screwdriver(15).
 Tighten the Screws fully in a sequential manner.
Caution: Leg(N) should be facing outwards. Misassembly and reassembly may cause damage and instability to the product.
Note: There are pre-existing mounting positions on the Bottom Panel to attach the Legs and Middle Leg.

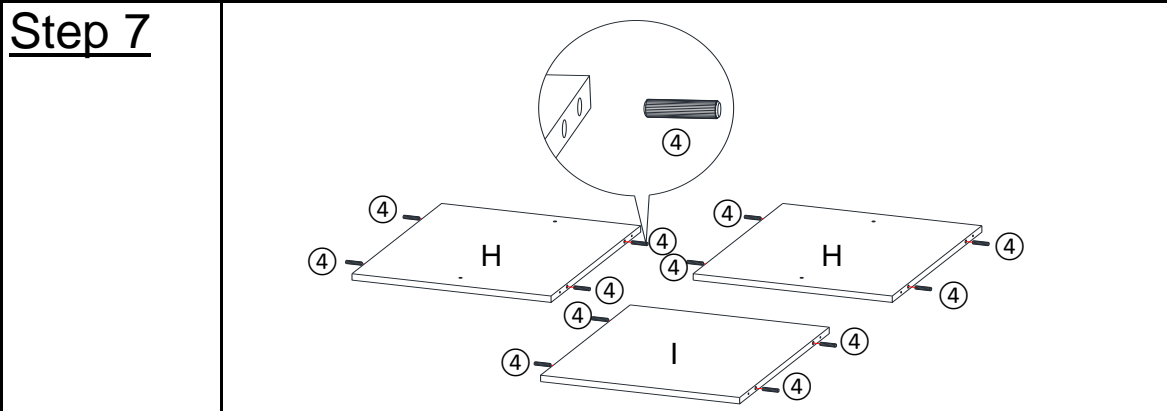

Insert Positioning Dowels(4) into mounting positions on Inner Side Left & Center Panel(H) and Inner Side Right Panel(I) by hand.

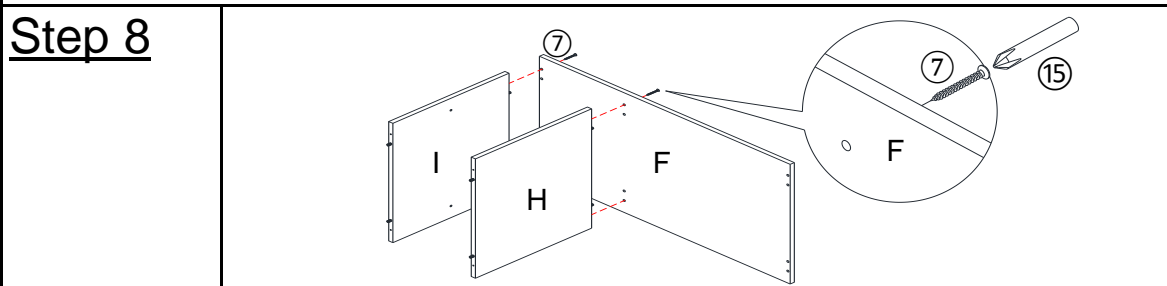

Attach Inner Top Panel(F) to Inner Side Right(I) & Inner Side Left & Center Panel(H) using Screws(7) with Screwdriver(15).

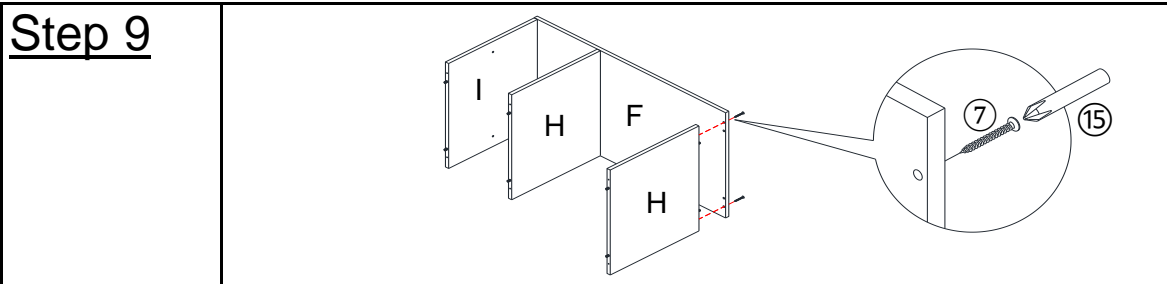

Attach Inner Top Panel (F) to Inner Side Left & Center Panel(H) using Screws(7) with Screwdriver(15).

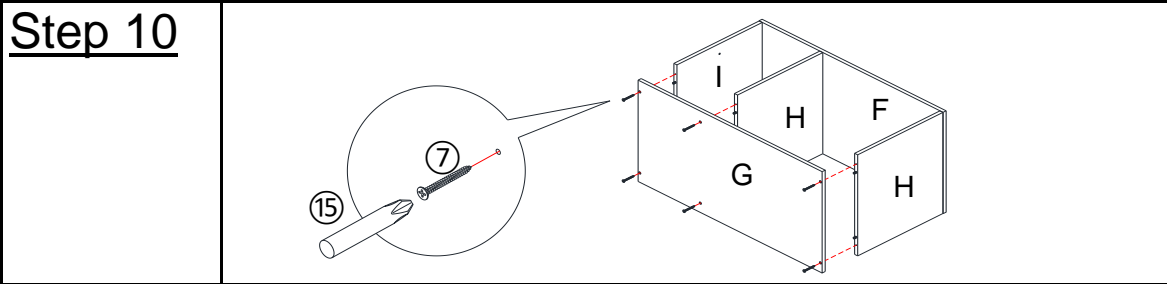

Attach Inner Bottom Panel(G) to Inner Side Left & Center Panel(H) and Inner Side Right Panel(I) using Screws(7) with Screwdriver(15).

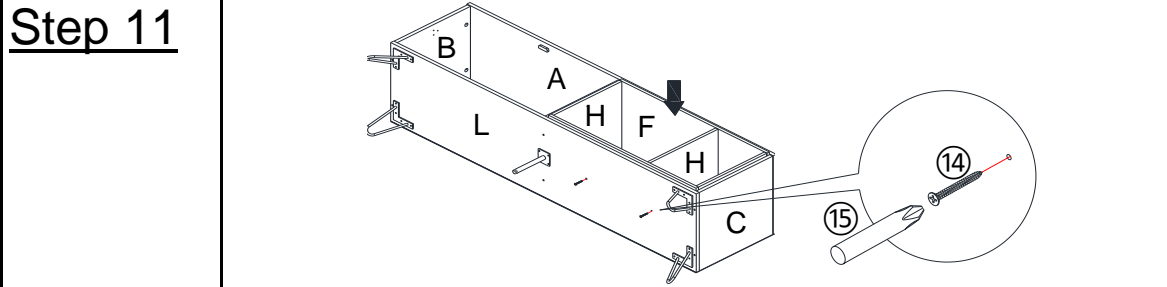

Flip the Whole TV Cabinet.
Attach the Rack to the TV Cabinet using Screws(14) with Screwdriver(15).

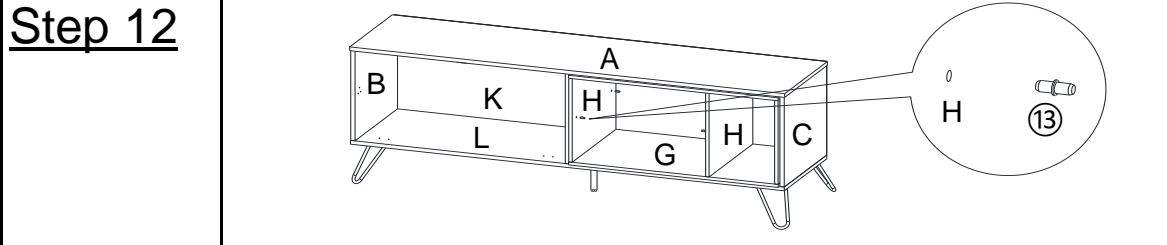

Flip the Whole TV Cabinet over.
Insert Metal Shelf Support(13) into mounting positions on Second Left & Right Panel(H) by hand.

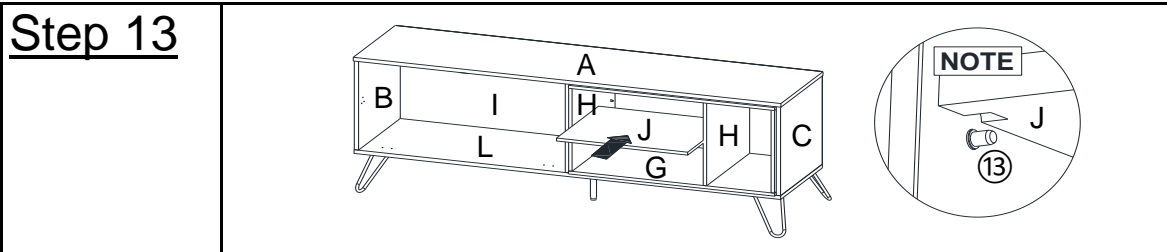

Put Shelf Panels(J) in place on Shelf Supports(13).
Note: There are lead mounting positions on Shelf Panels(J) to fit Metal Shelf Supports(13).

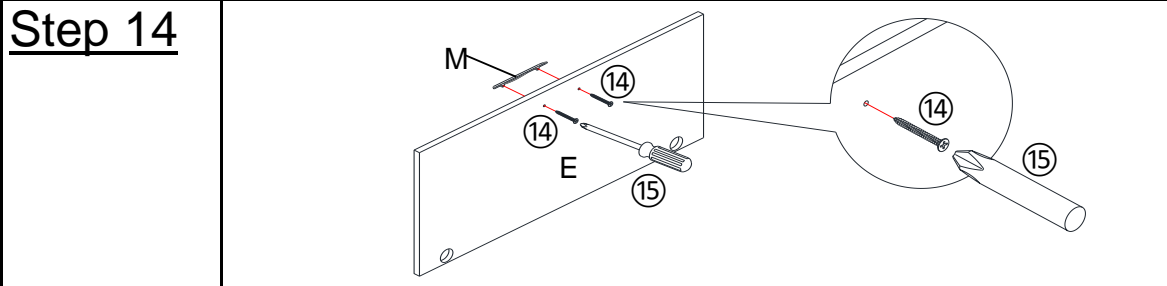

Attach Handle(M) to Door Panel(E) using Screws(14) with Screwdriver(15).
Tighten the Screws fully in a sequential manner.
Note: There are pre-existing mounting positions on the Door Panel to attach the Handle.

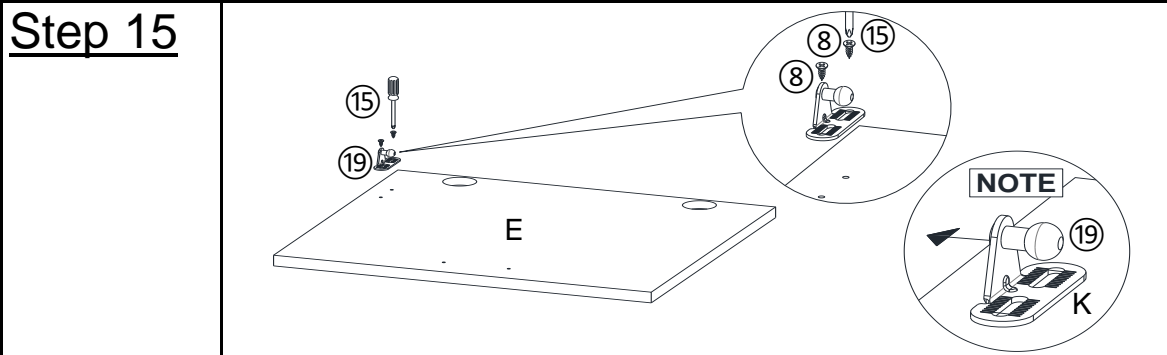

Attach Ball Connector Brackets(19) to Door Panel(E) using Screws(8) with Screwdriver(15).
Tighten the Screws fully in a sequential manner.
Note: There are pre-existing mounting positions on both Door Panels to fix the Ball Connector Brackets.
The flat faces of Ball Connector Brackets shall be facing the outer sides of Door Panels.

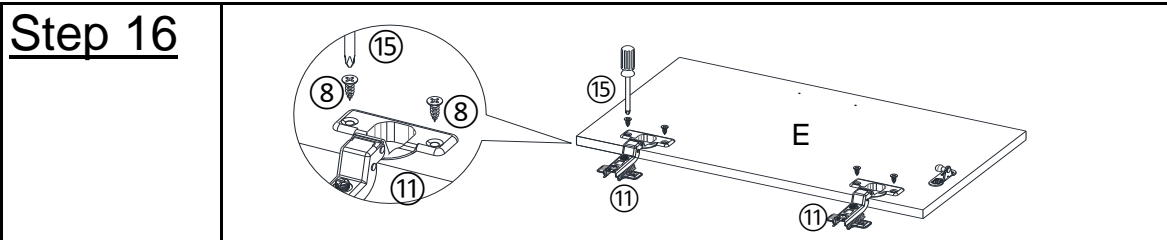

Attach Connectors(11) to Door Panels(E) using Screws(8) with Screwdriver(15).

Tighten the Screws fully in a sequential manner.

Note: There are pre-existing mounting positions on both Door Panels to fix Connectors.

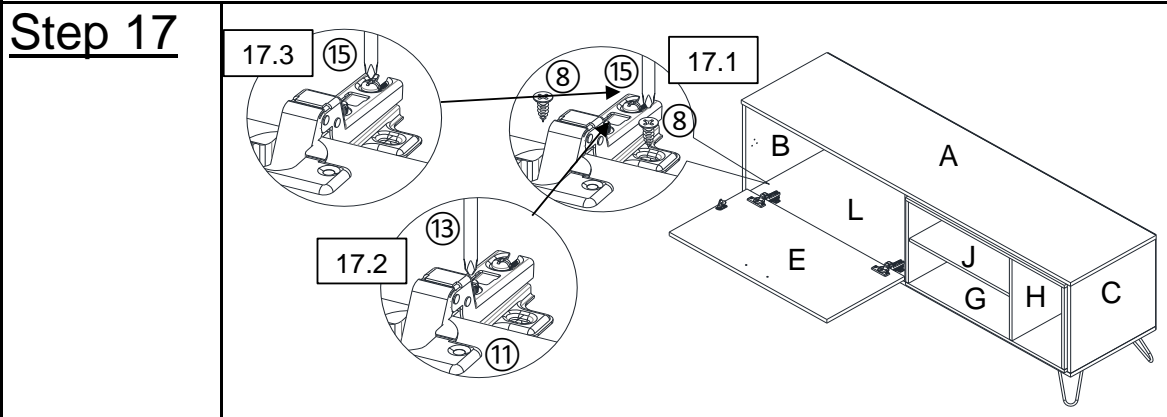

17.1) Attach Connectors(11) to Bottom Panel(L) using Screws(8) with Screwdriver(15).

Tighten the Screws fully in a sequential manner.

17.2) Rotate first screw on Connectors(11) to adjust up-down position of Door Panels(E) when necessary.

17.3) Rotate second screw on Connectors(11) to adjust in-out position of Door Panels(E) when necessary.

Note: There are pre-existing mounting positions on the Bottom Panel to attach the Connectors.

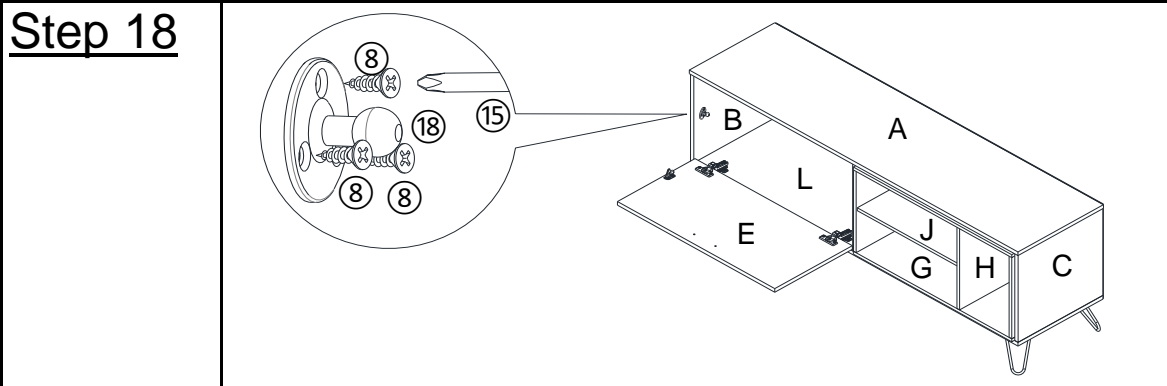

Attach Ball Connector(18) to Left Side Panel(B) using Screws(8) with Screwdriver(15).

Tighten the Screws fully in a sequential manner.

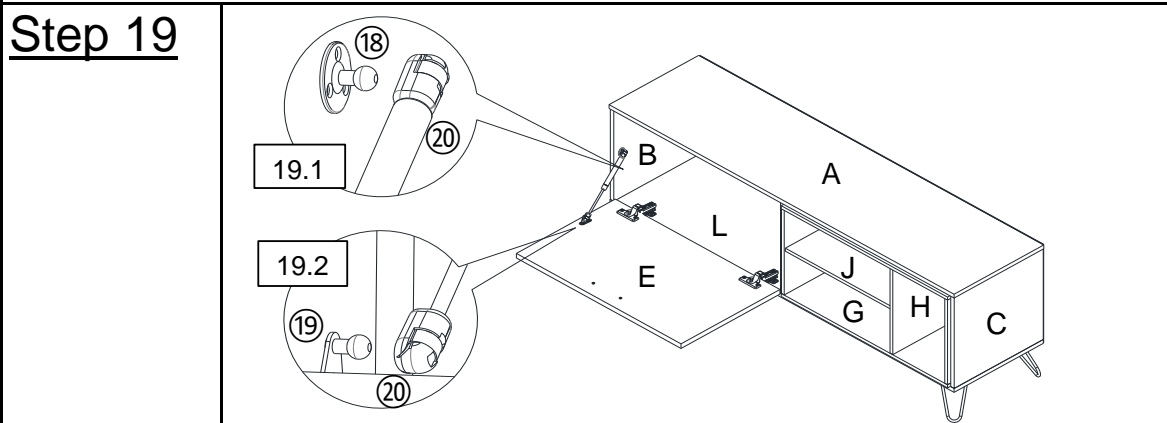

19.1) Insert Ball Connectors(18) from Left Side Panel(B) into Shock Absorbers(20) by hand.

19.2) Insert Ball Connector Brackets(19) from Door Panels(E) into Shock Absorbers(20) by hand.

Cabinet Restraint Device Installation Instructions

WARNING

Serious or fatal crushing injuries can occur from tipping furniture.
To help prevent tip-over: ALWAYS secure this furniture to the wall using Cabinet Restraint Device.

See product instructions for more ways to help prevent furniture tip-over.

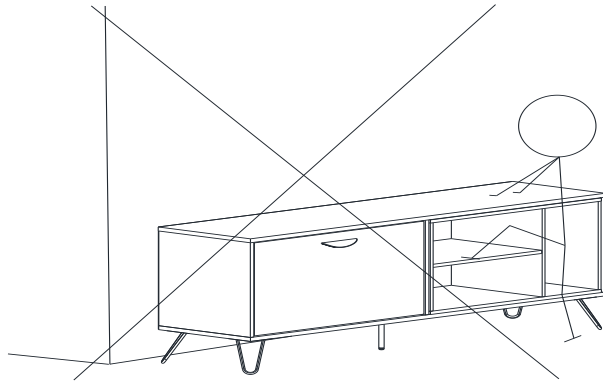

Usage For Cabinet Restraint Device:

To secure the Multi-Functional Cabinet against the wall, attach two Metal Brackets(21) on the wall and the product, use the Cabinet Restraint Strap(25) to connect the Metal Brackets(21).

Instructions:

Step 20

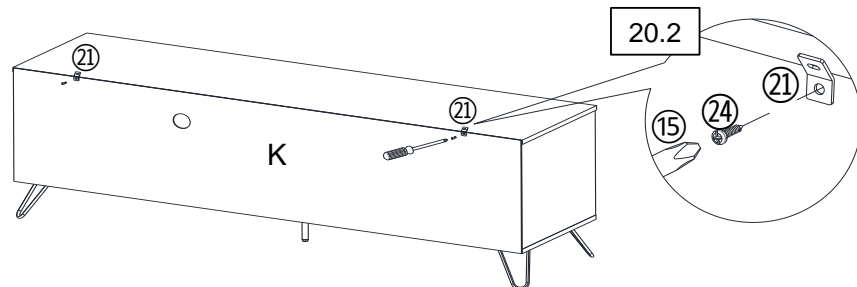

20.1) Turn the TV Cabinet so the back side faces you.

20.2) Attach Metal Brackets(21) to Back Panel(K), where Labeled using Pan Head Screws(24) with Screwdriver(15).

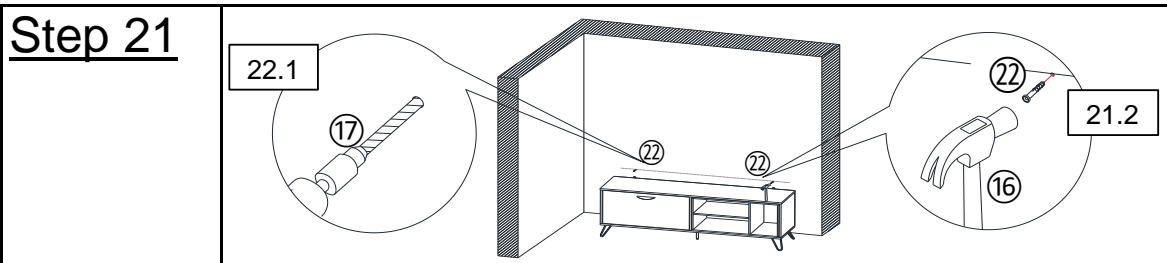

21.1) Drill two holes on wall at same height as Metal Brackets(21) on TV Cabinet with Power Drill(17).

You can mark these points in two ways as below:

1) Move the TV Cabinet back to the wall. Mark two points same height as TV Cabinet on the wall.

Note: The Metal Brackets need to be secured to solid, load bearing surface. Please use a Stud Finder(not supplied) if needed to locate the Wall Frame.

2) Measure the height of the Metal Brackets(21) with ruler/measuring tape and mark on wall to keep them accurate and same height.

21.2) Insert Wall Plugs(22) into drilled holes on wall with Hammer(16).

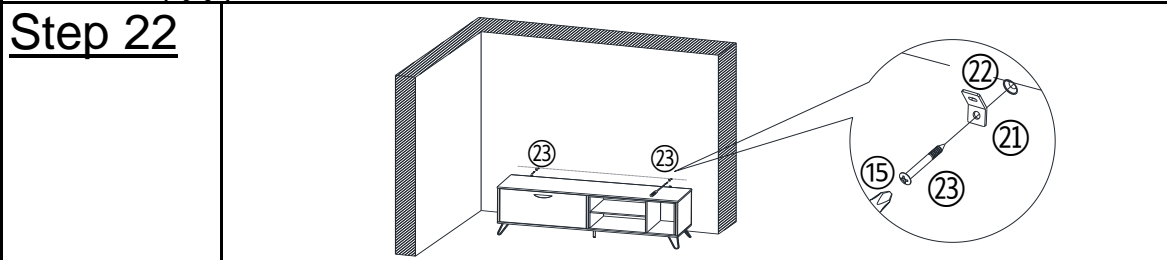

Attach Metal Brackets(21) to Wall Plugs(22) using Wall Plug Screws(23) with Screwdriver(15).

Step 23

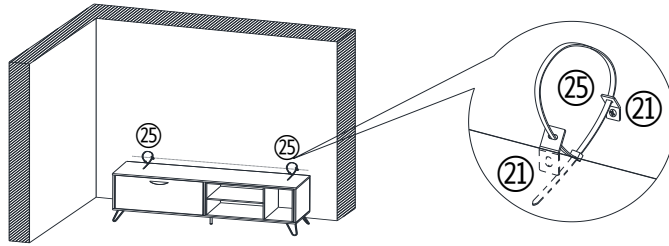

Move TV Cabinet to the wall.

Pull the Restraint Straps(25) through the Metal Brackets(21) on the wall and TV Cabinet one by one, and pull the Restraint Straps(25) tight.



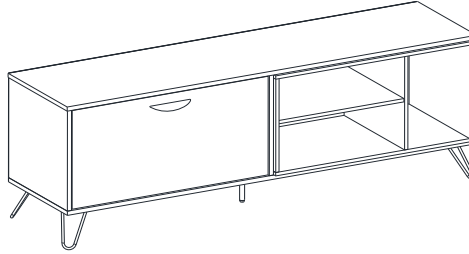







Step 24



Your TV Cabinet is ready for use.

This TV Cabinet can only be used on a flat, level surface.

Care & Maintenance

- ⊘  ● Do not put hot items directly on furniture surface
 - ⊘  ● Do not clean furniture with harsh cleansers or polish.
 - ⊘  ● Do not place furniture under direct sunlight.
 - ⊘  ● Do not place furniture near heating or cooling vents.
 - ⊘  ● Do not write on furniture without a padded barrier to protect the surface.
 - ⊘  ● Do not place furniture outside . For indoor use only .
 - ⊘  ● Not for commercial use. For residential use only .
 - ⊘  ● Stains may be removed with mild soap solution and damp cloth.
 - ⊘  ● Children should not climb or jump on the furniture.
-
- ✓  ● Dust and pick-up spills using a clean, non-colored, lint-free cloth .