

ASSEMBLY INSTRUCTION

Thank you for purchasing this quality product. Be sure to check all packing material carefully for small parts, which may have come loose inside carton during shipment. Identify and count all parts and compare with the parts list below.

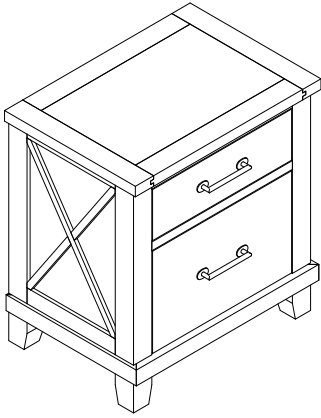







ASSEMBLY INSTRUCTION :

1. Remove hardware from box and sort by size.
2. Please check to see that all hardware and parts are present prior start of assembly.
3. Please follow attached instruction in the same sequence as numbered to assure fast and easy assembly

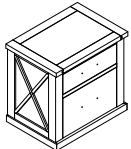
WARNING !

1. Don't attempt to repair or modify parts that are broken or defective. Please contact the store immediately.
 2. This product is for home use only and not intended for commercial establishments.
 3. Two persons are required for assembly.
 4. Approximate assembly time : 1/2 hours.
 5. Component parts and fittings contained in the box.
- Please sort out all parts before you begin to assemble the item.
This is to make sure you always use the correct part .

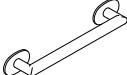
PARTS LIST :

No.	Component	Q'ty
A	 DRAWER NIGHTSTAND	1PC
B	 Legs	4PCS
1	 Medium bolt (M6x60mm)	4PCS
2	 ALLEN KEY	1PCS
3	 INPOSITIONG PIN	8PCS
4	 HANDLE	2PCS
5	 MEDIUM PAN HEAD SCREW (M4X25MM)	4PCS

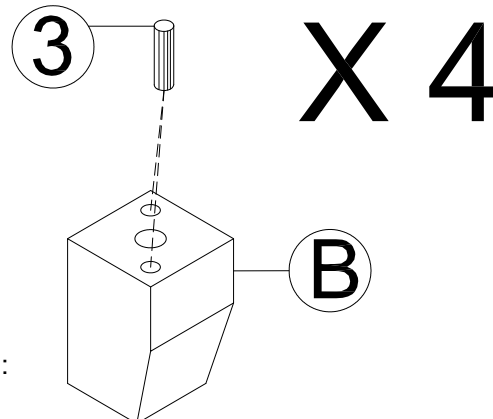

ASSEMBLY INSTRUCTIONS

