

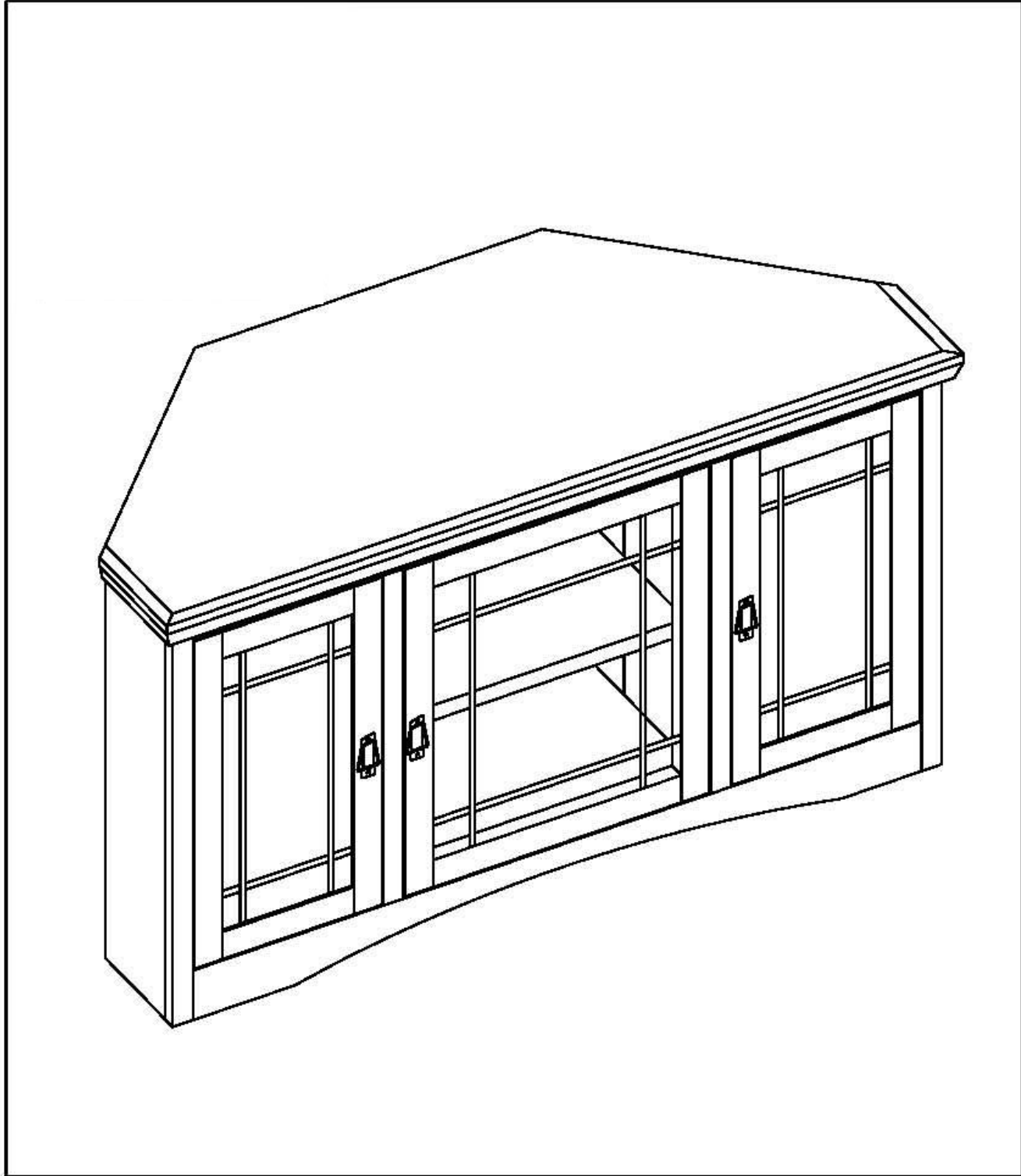





Mission OAK 25" H, 46" W Corner TV Cart With Storage

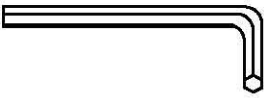
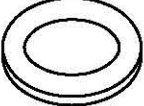
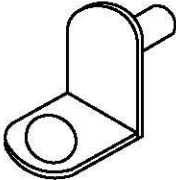
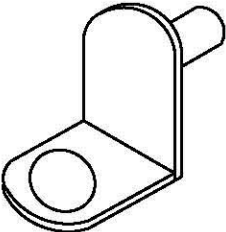
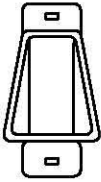

Hardware List

Item	Description	Qty
a	 Bolt 1/4" * 1-1/8"	3PCS
b	 Allen wrench	1PC
c	 Washer 1/4" * 12mm	3PCS
d	 Shelf metal clip	12PCS
e	 Bigger Shelf metal clip	2PCS
f	 Door Pull	3PCS
g	 Machine screw for Door pull 5/32" * 3/4"	6PCS

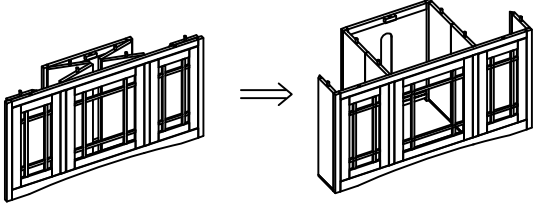
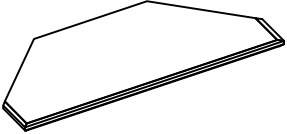
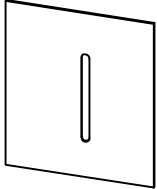
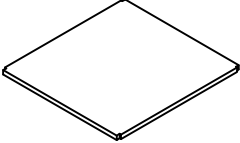
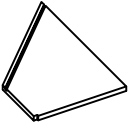
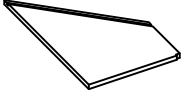
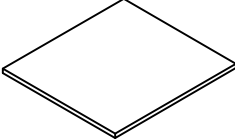
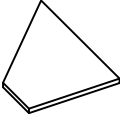
Parts List

Item	Description	Qty
A	 Cabinet	1PC
B	 Top Panel	1PC
C	 Side Back Panel	2PCS
D	 Middle Bottom Panel	1PC
E	 Left Side Bottom Panel	1PC
F	 Right Side Bottom Panel	1PC
G	 Middle Adjustable Shelf	1PC
H	 Left Side Adjustable Shelf	1PC
I	 Right Side Adjustable Shelf	1PC

Assembly Instructions

Two person assembly recommended.

step 1

Unfold Cabinet.

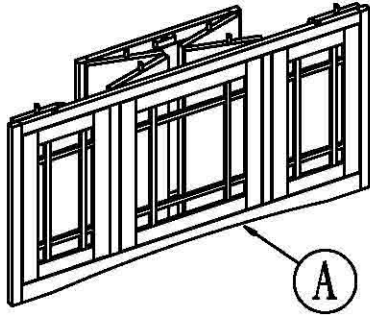

step 2

Install two bigger shelf clips on the side bottom.

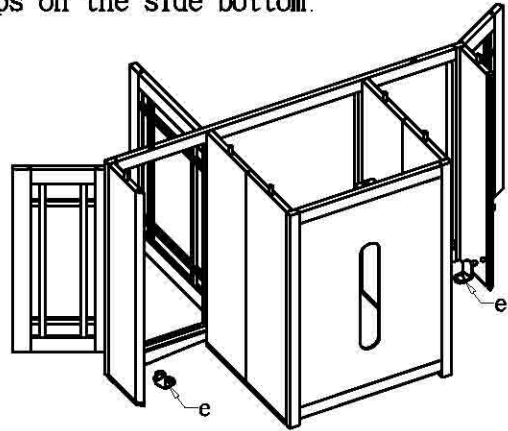

step 3

Insert the center bottom panel first, then insert the side bottom panel.

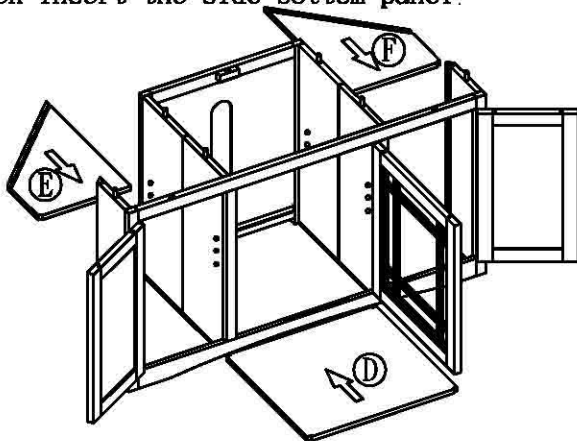

step 4

Insert two side back panels.

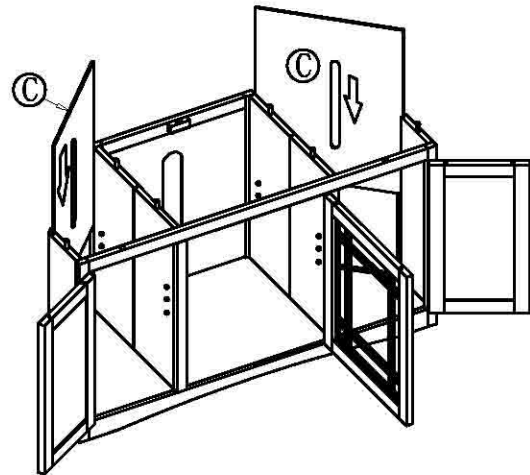

step 5

Bolt on top with 3 bolts.
DO NOT OVER TIGHTEN

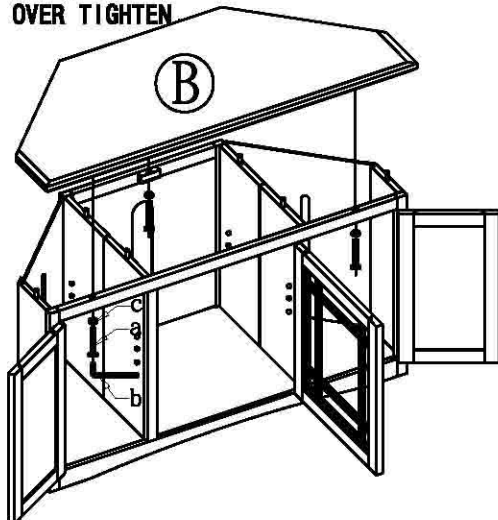

step 6

Install shelf clips and insert shelves and door pulls.

