



















ASSEMBLY INSTRUCTIONS

Thank you for purchasing this quality product. Be sure to check all packing material carefully for small Hardware which may have some loose inside the carton during shipment. Identify and count all Hardware. Identify and count all Hardware and compare with the Hardware List Below.

PARTS LIST				HARDWARE LIST				
No.	Description	Sketch	Q'ty	No.	Description	Sketch	Size	Q'ty
A	Headboard Panel		1pc	1	Allen Bolt		Ø5/16"x45mm	8pcs
B	Left/ Right H/B Post		2pcs	2	Spring Washer		Ø5/16"	12pcs
C	Footboard Panel		1pc	3	Flat Washer		Ø5/16"x19mm	12pcs
D	H/B Cross Bar Support		1pc	4	Thread Bolt		Ø5/16"x82mm	8pcs
E	Bed Side Rails		2pcs	5	Cuved Washer		Ø5/16"	8pcs
F	Slats		4pcs	6	Hex Nut		Ø5/16"x18mm	8pcs
G	Slat Support Legs		8pcs	7	Screw		Ø4x32mm	16pcs
H	Right Bun Foot		1pc	8	Open Wrench		Ø5/16"	1pc
I	Left Bun Foot		1pc	9	Allen Key		4mm	1pc
				10	Allen Bolt		Ø5/16"x38mm	4pcs

Step 1:

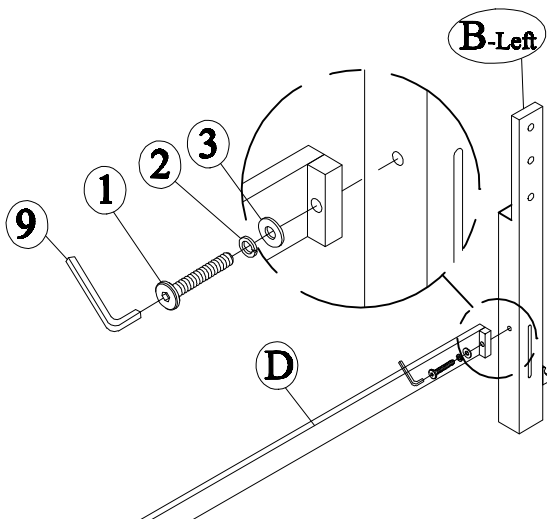

Step 2:

