

WARNING

- * Switch off the main electrical supply from the main fuse box / circuit breaker before installation.
- * Inspect item carefully before attempting to install.
- * If there is any damages or obvious defects, do not install.
- * Item may not be returned once it has been installed.

CARE AND MAINTENANCE

- * To clean the outside of the fixture, use a dry or slightly dampened clean cloth (use clean water, never a solvent) to wipe the surface of the fixture.
- * To clean the inside of the fixture, first disconnect power to the fixture by turning off the circuit breaker or by removing the fuse at the fuse box. Next, use a dry or slightly dampened clean cloth (use clean water, never a solvent) to wipe the interior surface of the fixture.
- * Do not use any cleaners with chemical, solvents or harsh abrasives. Use only a dry soft cloth to dust or wipe carefully.







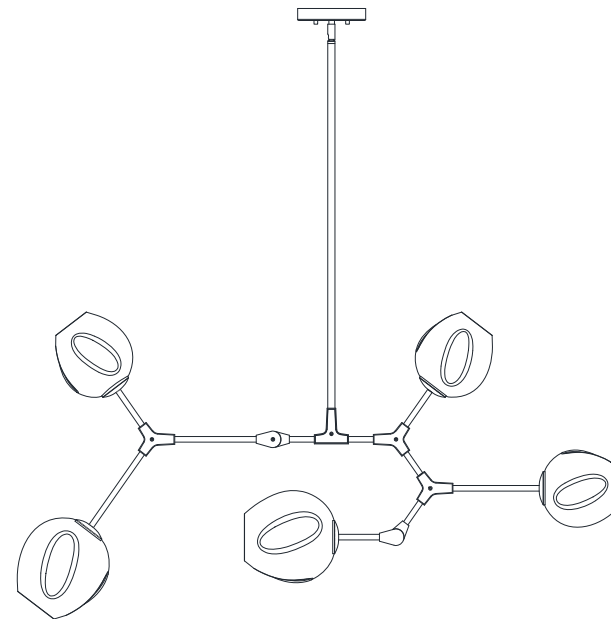





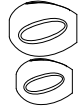

NOTICE& IMPORTANT SAFETY INSTRUCTIONS

- ** WE RECOMMEND INSTALLATION OF THIS LIGHTING FIXTURE BE DONE BY A LICENSED ELECTRICIAN **
- * Please make sure that you have all parts indicated before you begin assembly of this item
- * This item should be assembled on a soft surface to prevent scratching the finish during assembly
- * To reduce the risk of fire, electrical shock or injury to persons or property, please follow the guideline below for safe use and installation
- *The external flexible cable or cord of this lamp cannot be replaced
If the cord is damaged, the lamp shall be destroyed

Product Dimensions: 48"L X 32"W X 7.5H

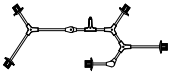

Part List and Hardware List

PIECE	DESCRIPTION	PICTURE	QUANTITY	PIECE	DESCRIPTION	PICTURE	QUANTITY	PIECE	DESCRIPTION	PICTURE	QUANTITY
A	mounting bracket		1X	F	screwed ball		2X	K-1 K	glass		2X 3X
B	mounting screw 8/32*32mm		2X	G	pipe swing		1X	L	socket ring		5X
C	ground screw 5/32*8mm		1X	H	tube		12" - 2X 6" - 2X	M	bulb		5X
D	wire connector		3X	I	main fixture		1X	N	Machine screw 8/32*25mm		2X
E	canopy		1X	J	lampholder E26		5X				

PREPARATION

- * Before beginning assembly of product, make sure all parts are present. Compare parts with package contents list and hardware contents list.
- * If any part is missing or damaged, do not attempt to assemble the product.
- * Estimated Assembly Time: 20 minutes.
- * Tools Required for Assembly (not included): Screwdriver, Junction box
- * If you are having difficulty, our friendly Customer Care team is always here to help.

NOTE: PLEASE USE TYPE"A" BULB MAX 40-WATT OR LED BULB MAX 9-WATT, THERE ARE 5PCS LED 4-WATT BULB IN THE BOX

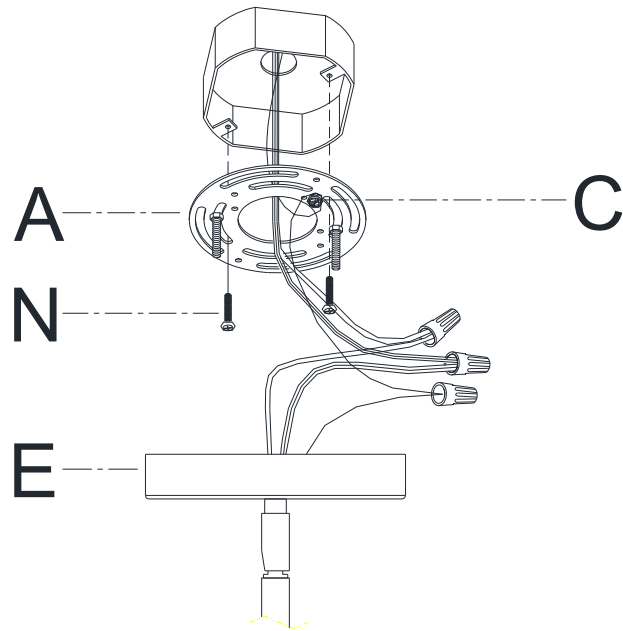

Step 1: First, the mounting screw(N) is fixed on the machine wire box through the mounting bracket (A)

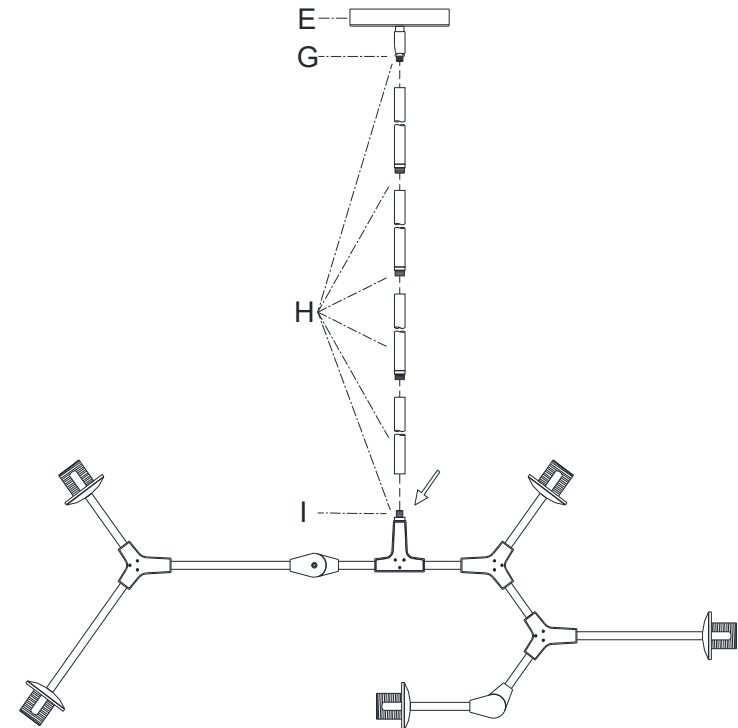

Step 2: Unpack all parts from cartons carefully.
Connect the tubes(H) together to get desired length and screw the top end into the coupling(G) beneath the canopy,the bottom end to the connection tube on top of main fixture(I) .

PREPARATION

- * Before beginning assembly of product, make sure all parts are present. Compare parts with package contents list and hardware contents list.
- * If any part is missing or damaged, do not attempt to assemble the product.
- * Estimated Assembly Time: 20 minutes.
- * Tools Required for Assembly (not included): Screwdriver, Junction box
- * If you are having difficulty, our friendly Customer Care team is always here to help. Please email customersupport@safavieh.com

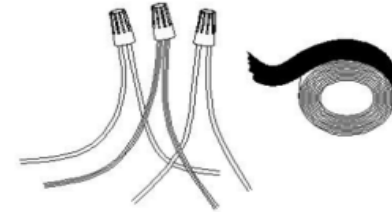
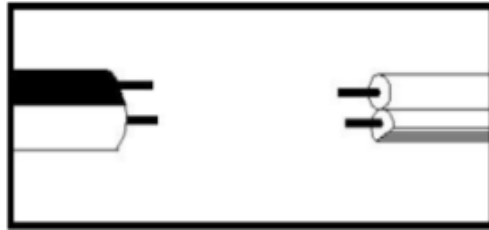
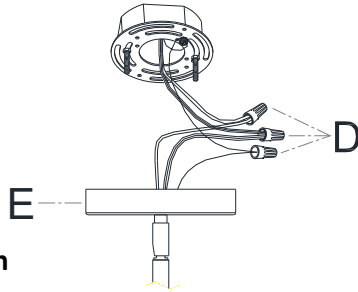

Step 3: wire connection

Connect fixture neutral wire (ribbed) to the outlet box neutral wire (usually white) using a wire nut.

Connect fixture hot wire (smooth with markings) to the outlet box hot wire (usually black) using a wire nut.

CAUTION: Do not reverse the hot and neutral connections

Grounding Instructions: Wrap ground wire from outlet box around green ground screw(C) on mounting bracket, no less than 2" from wire end. Tighten ground screw. If fixture is supplied with a ground wire, connect to outlet ground wire with a wire connector.

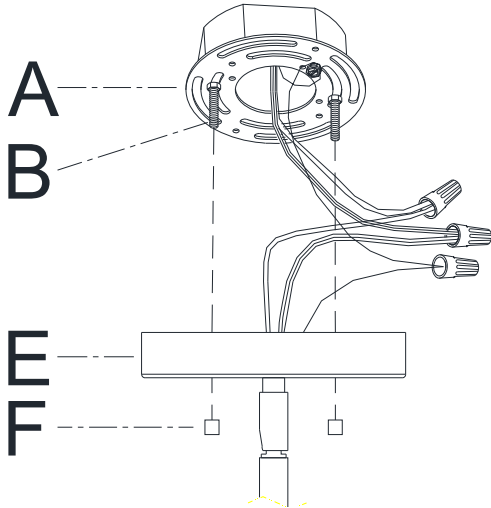

Step 4: Fix the mounting bracket(A) to the outlet box with machine screw(B).

Attach the Canopy(E) to the Mounting bracket (A) and fix it by turning the screwed ball (F).

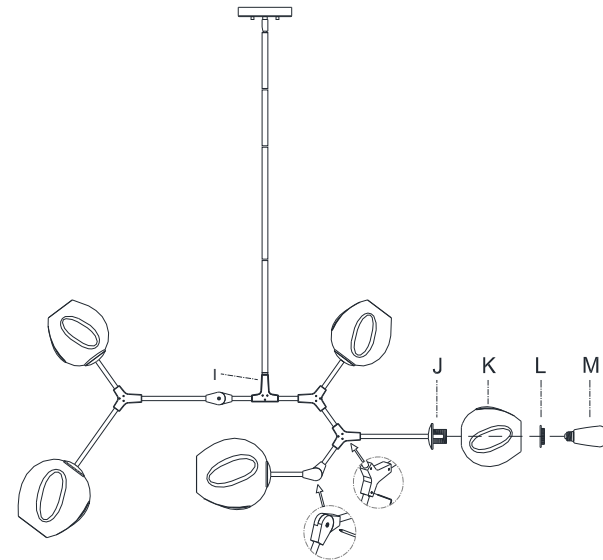

Step 5: Fix the glass shade(K) to the lampholder(J) with socket ring(L).

Install bulbs(M). Be sure to use light bulb(S) with wattage no greater than specified on this fixture. Always make sure that electrical current is turned off before changing bulbs.