

ASSEMBLY INSTRUCTIONS

20INCH BATH VANITY (COMBO)

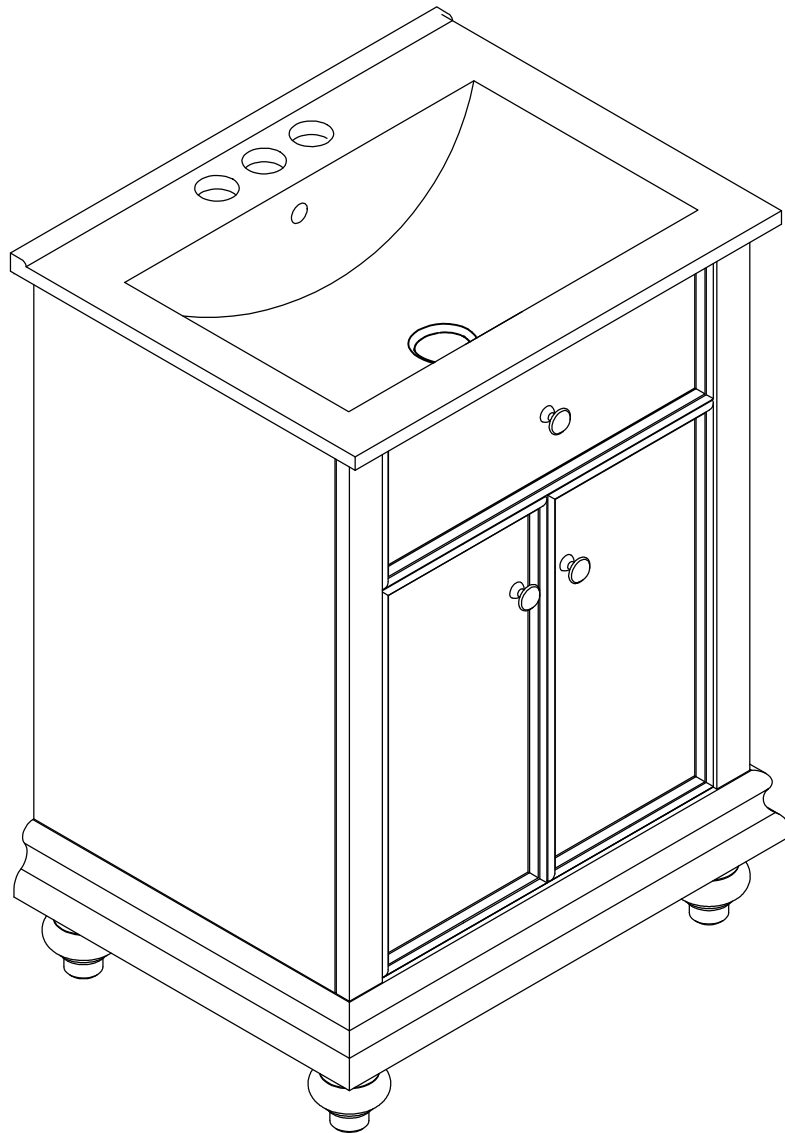

Thank you for purchasing this quality product. Be sure to check all packing material carefully for small parts which may have come loose inside the carton during shipment. Separate, identify and count all parts and hardware.

Compare with the parts list to be sure all parts are present.

"DO NOT TIGHTEN SCREWS UNTIL COMPLETELY ASSEMBLED"

*** Use of power tool to assemble this product will invalidate any claim and damage this product making unsafe!!!**
*** Please assemble on a clean soft surface to avoid damage.**

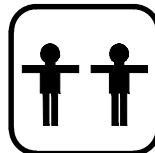
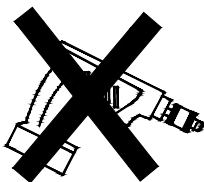

+

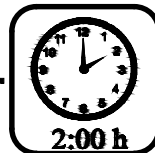

Tools Required

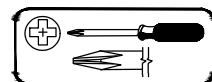

(Not Included)

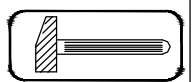

(Not Included)

IMPORTANT:
PLEASE READ INSTRUCTION BEFORE STARTING THE ASSEMBLY

PLEASE DO NOT RETURN TO STORE

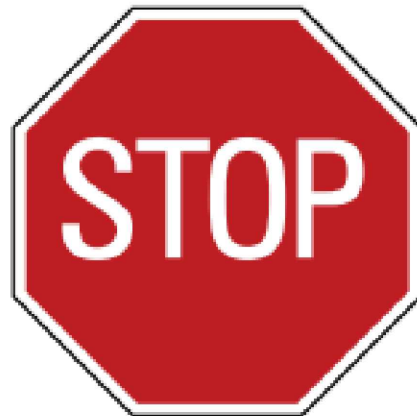

**Please do not return this product to the retailer!!
We are able to assist you in ANY way**

If you find that you have any trouble with assembly or missing or damaged parts please contact the seller.

Before Installation

Important - Please read these instructions fully before starting assembly

Thank you for purchasing this quality product. Be sure to check all packing materials carefully for small parts, which may have come loose inside the carton during shipment. Identify and count all items according to the PARTS LIST and/or HARDWARE LIST shown below. Check you have all the components and tools listed on the following pages.

- . We recommend that you assemble this product with the assistance of another person; this will make the assembly easier, and will help eliminate damage to the product or injury to persons during assembly.
- . Please do not over tighten screws or bolts until the assembly is completed.
- . Keep children and animal away from the work area, small parts could choke if swallowed.
- . Please put all parts on a non-abrasive floor before assembly, and follow the assembly steps to assemble your newly purchased product correctly and efficiently.

If you find that you have any trouble with assembly or missing or damaged parts please contact the seller.

Cam Lock Assembly Instructions

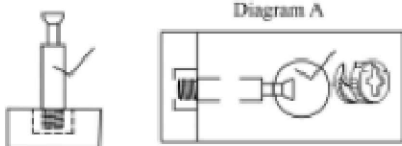
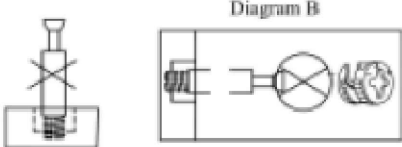
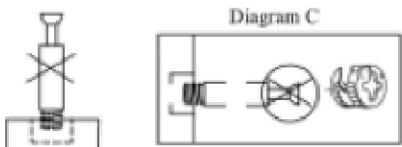
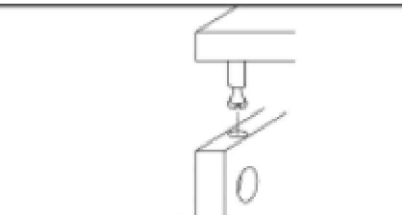
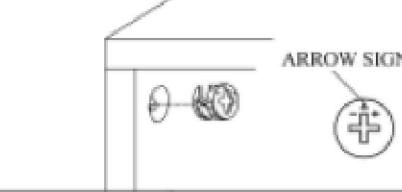
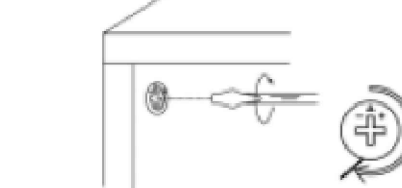
	<p>Diagram A</p> <p>Insert Cam Bolt into hole as shown in diagram A.</p>
	<p>Diagram B</p> <p>Make sure not to insert the Cam Bolt: Too deep as shown in figure B as this will cause the Cam Lock to be misaligned and unable to interlock properly.</p>
	<p>Diagram C</p> <p>Also avoid inserting the Cam Bolt too close to the surface of the hole as shown in figure C, as this will cause the Cam Lock to be too loose, and not interlock properly.</p>
	<p>Connect the panels together.</p>
	<p>ARROW SIGN</p> <p>Insert the Cam Lock so the side opening fits over the head of the Cam Bolt.</p>
	<p>To tighten the Cam Lock, turn it clockwise on half a turn with a flat screwdriver. <i>*Do not use an automatic screwdriver as it may bend or break if too much power is imposed.</i></p>

Detail View - CABINET

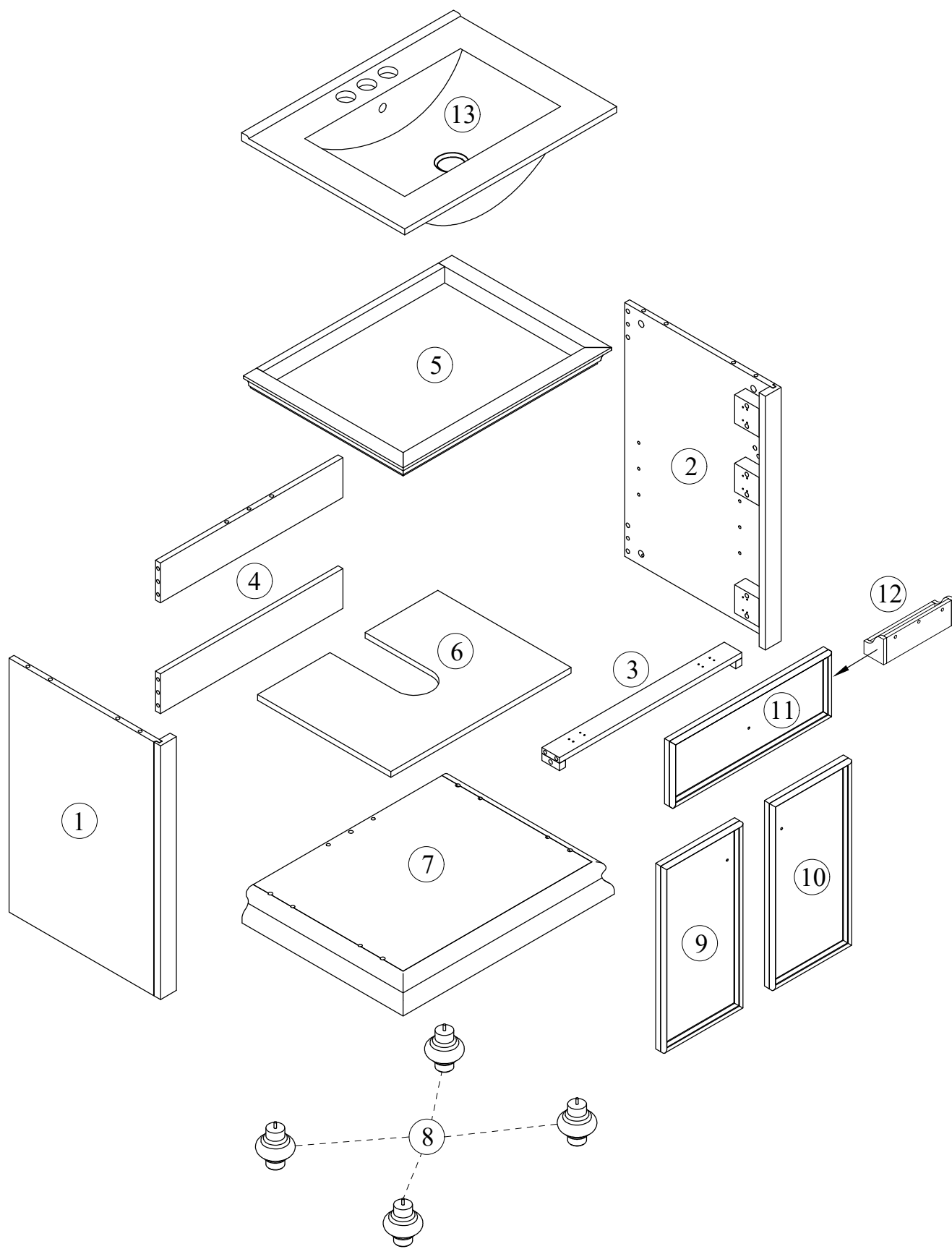





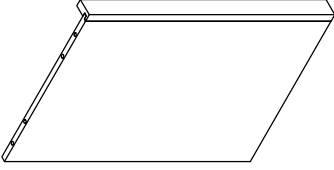
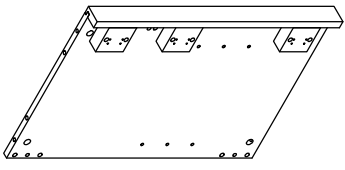
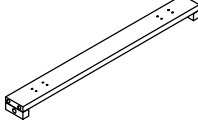
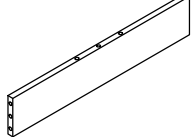
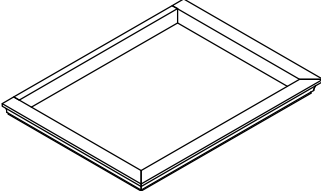
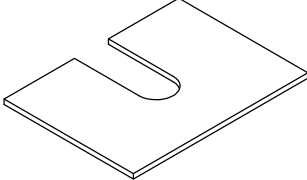
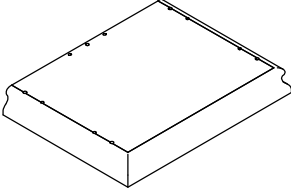
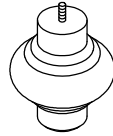
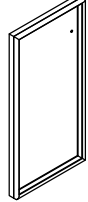
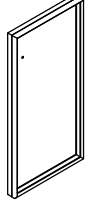
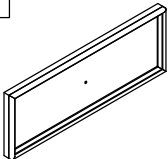
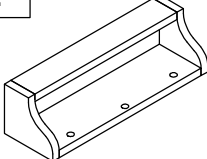
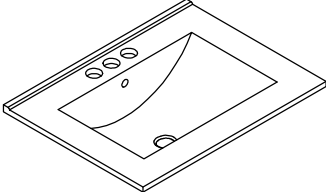

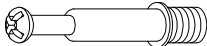
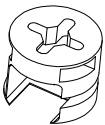
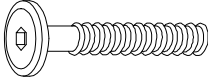
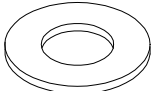

Identifying the Hardware-Identify the hardware using the illustrations below.

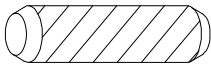
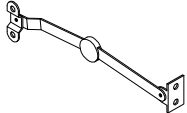
Part List - N710P446538

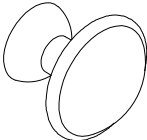
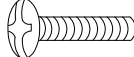
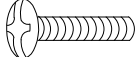
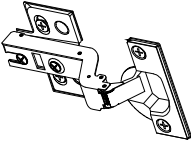
<p>1</p>	 <p>Left Frame - 1pc</p>	<p>2</p>	 <p>Right Frame - 1pc</p>
<p>3</p>	 <p>Front Bar - 1pc</p>	<p>4</p>	 <p>Top & Bottom Panel Rear - 2pcs</p>
<p>5</p>	 <p>Top Frame - 1pc</p>	<p>6</p>	 <p>Adjustable Shelf - 1pc</p>
<p>7</p>	 <p>Base Frame - 1pc</p>	<p>8</p>	 <p>Leg - 4pcs</p>
<p>9</p>	 <p>Door (L) - 1pc</p>	<p>10</p>	 <p>Door (R) - 1pc</p>
<p>11</p>  <p>Upper Door - 1pc</p>	<p>12</p>  <p>Back Storage - 1pc</p>	<p>13</p>	 <p>Sink - 1pc</p>

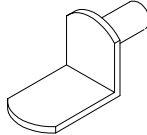
Hardware List - N710P446538

<p>A</p>  <p>Ø6x35mm</p>	<p>B</p>  <p>Ø14.5x12mm</p>	<p>C</p>  <p>Ø1/4x28mm</p>
<p>Three in one bolts(18pcs)</p>	<p>Three in one lock(18pcs)</p>	<p>Hex-Head bolts (2pcs)</p>
<p>D</p>  <p>Ø1/4"*16*1mm</p>	<p>E</p>  <p>4mm</p>	<p>F</p>  <p>Ø8x30mm</p>
<p>Washer (2pcs)</p>	<p>Allen key(1pc)</p>	<p>Wood dowel(20pcs)</p>
<p>G</p> 	<p>H</p>  <p>Ø6xØ3x12mm</p>	<p>I</p>  <p>Ø8xØ4x19mm</p>
<p>Support Arm(1pc)</p>	<p>Flat head screw(4pcs)</p>	<p>Round head screw(2pcs)</p>
<p>J</p> 	<p>K</p>  <p>Ø5/32"x32mm</p>	<p>L</p>  <p>Ø5/32"x22mm</p>
<p>Handle(3pcs)</p>	<p>Handle screw(1pc)</p>	<p>Handle screw(2pcs)</p>
<p>M</p> 	<p>N</p>  <p>Ø7xØ3.5x12mm</p>	<p>O</p> 
<p>Damping hinge (6pcs)</p>	<p>Flat head screw(36pcs)</p>	<p>Laminate pad(4pcs)</p>
<p>P</p>  <p>Anti fall hardware (2sets)</p>		

STEP: 1



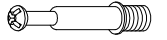

A

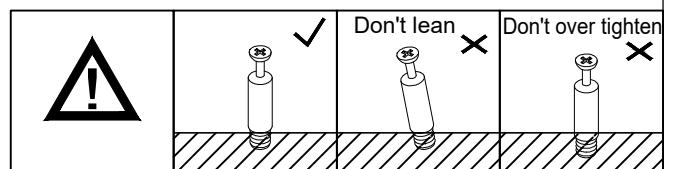
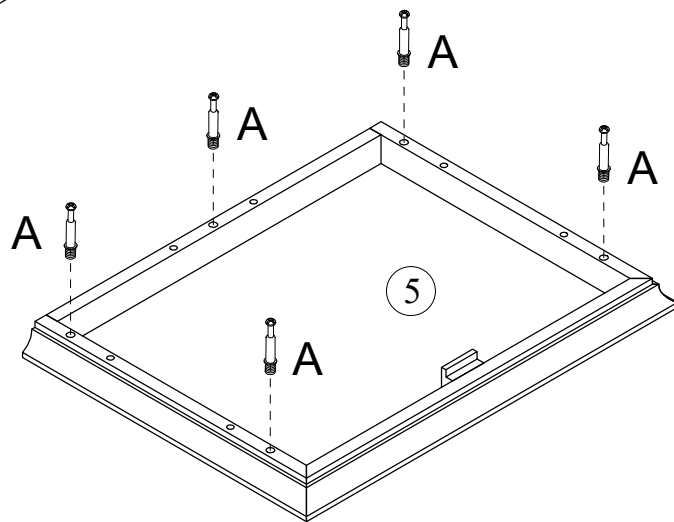
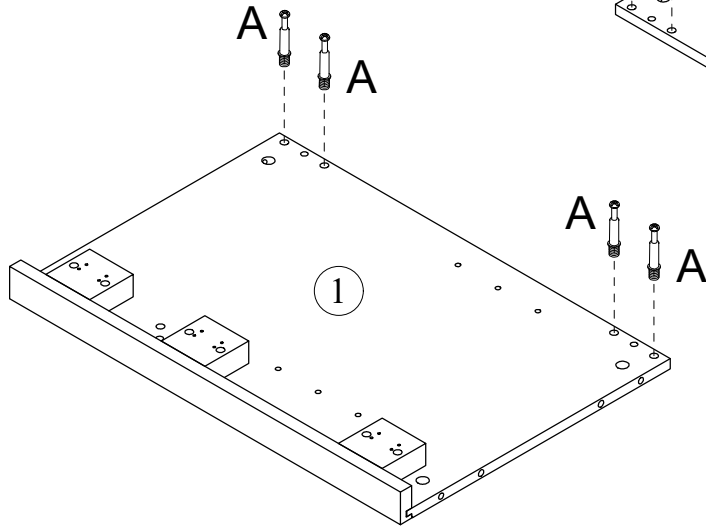
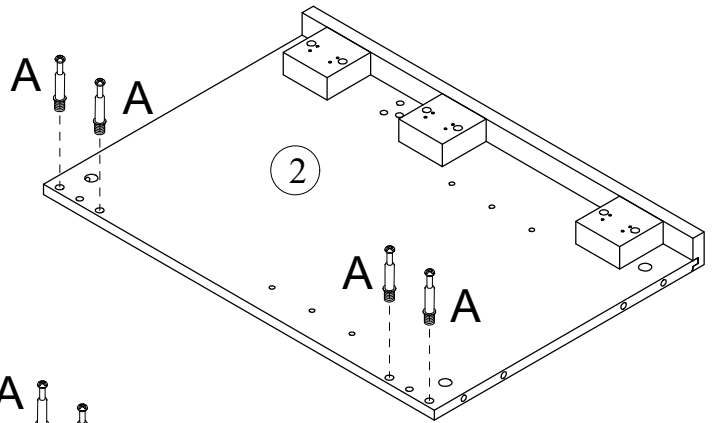
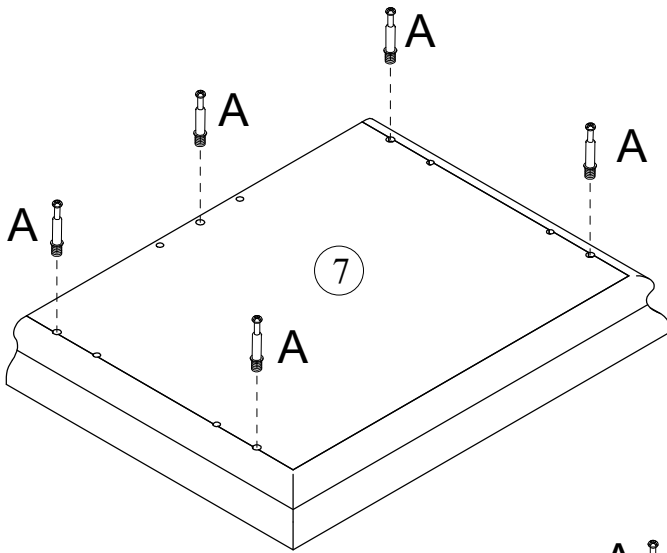

18PCS



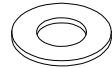

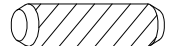
STEP: 2

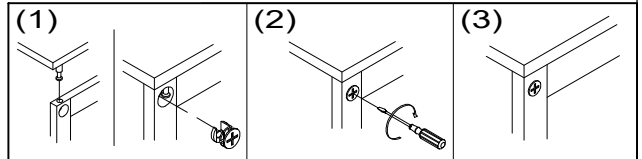
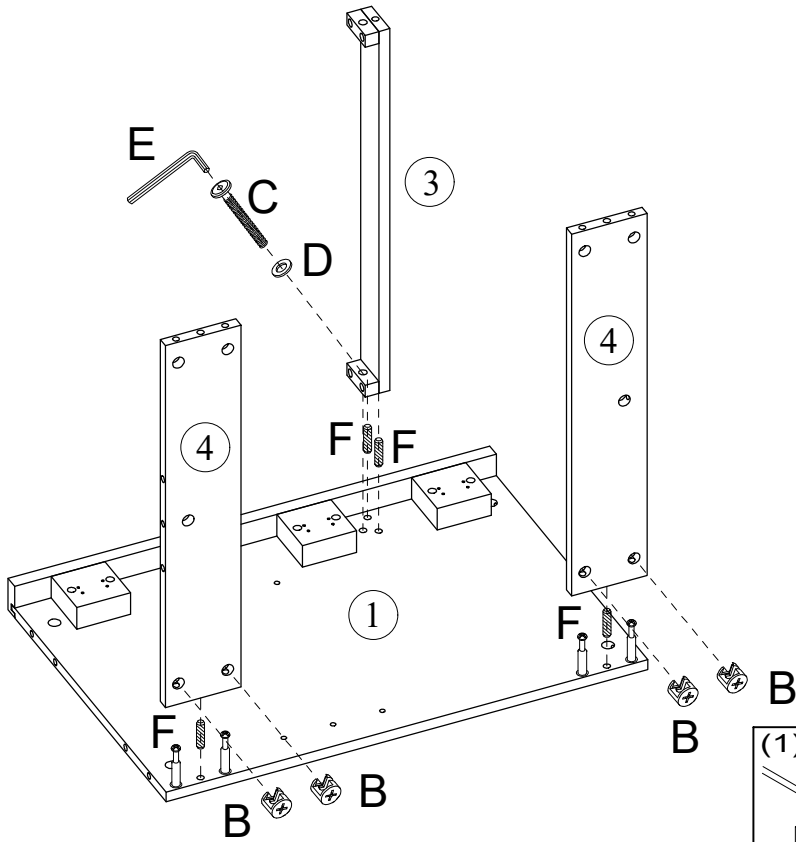
B		C		D		E		F	
4PCS		1PC		1PC		1PC		4PCS	

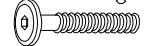
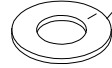

STEP: 3

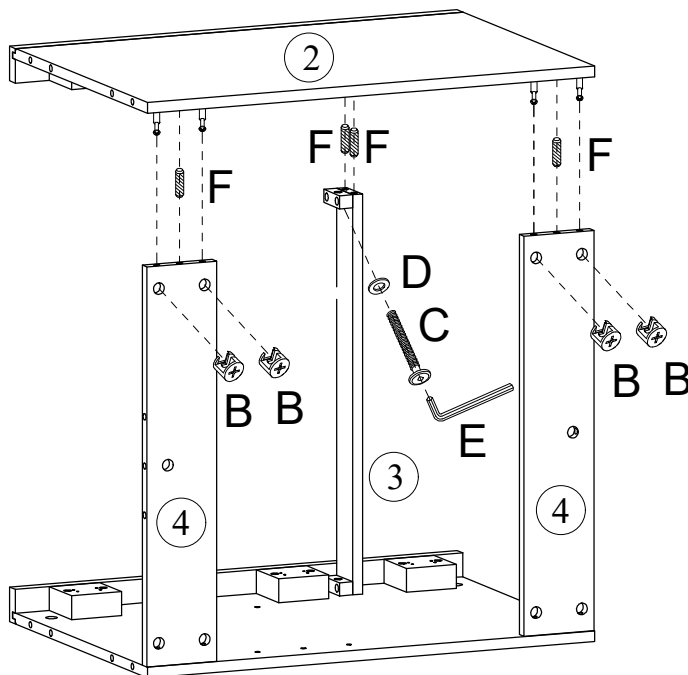

B		C		D		E		F	
4PCS		1PC		1PC		1PC		4PCS	

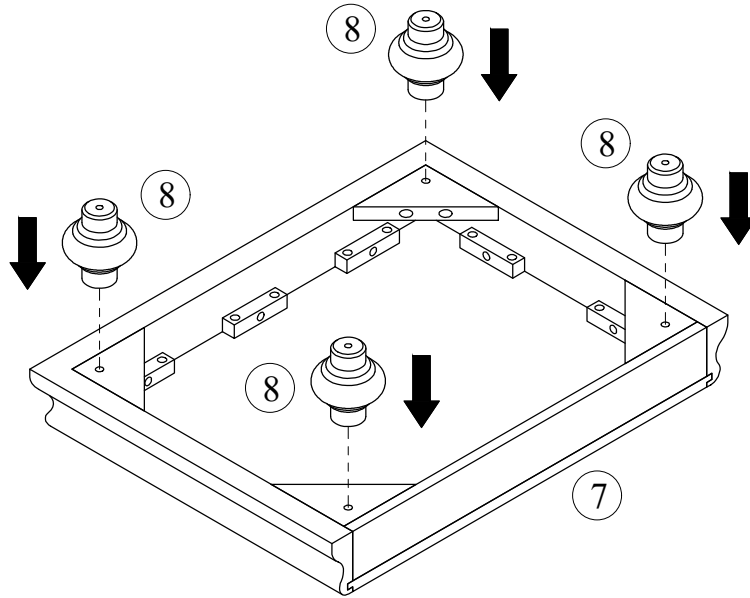

STEP: 4



STEP: 5

B		F	
	5PCS		6PCS

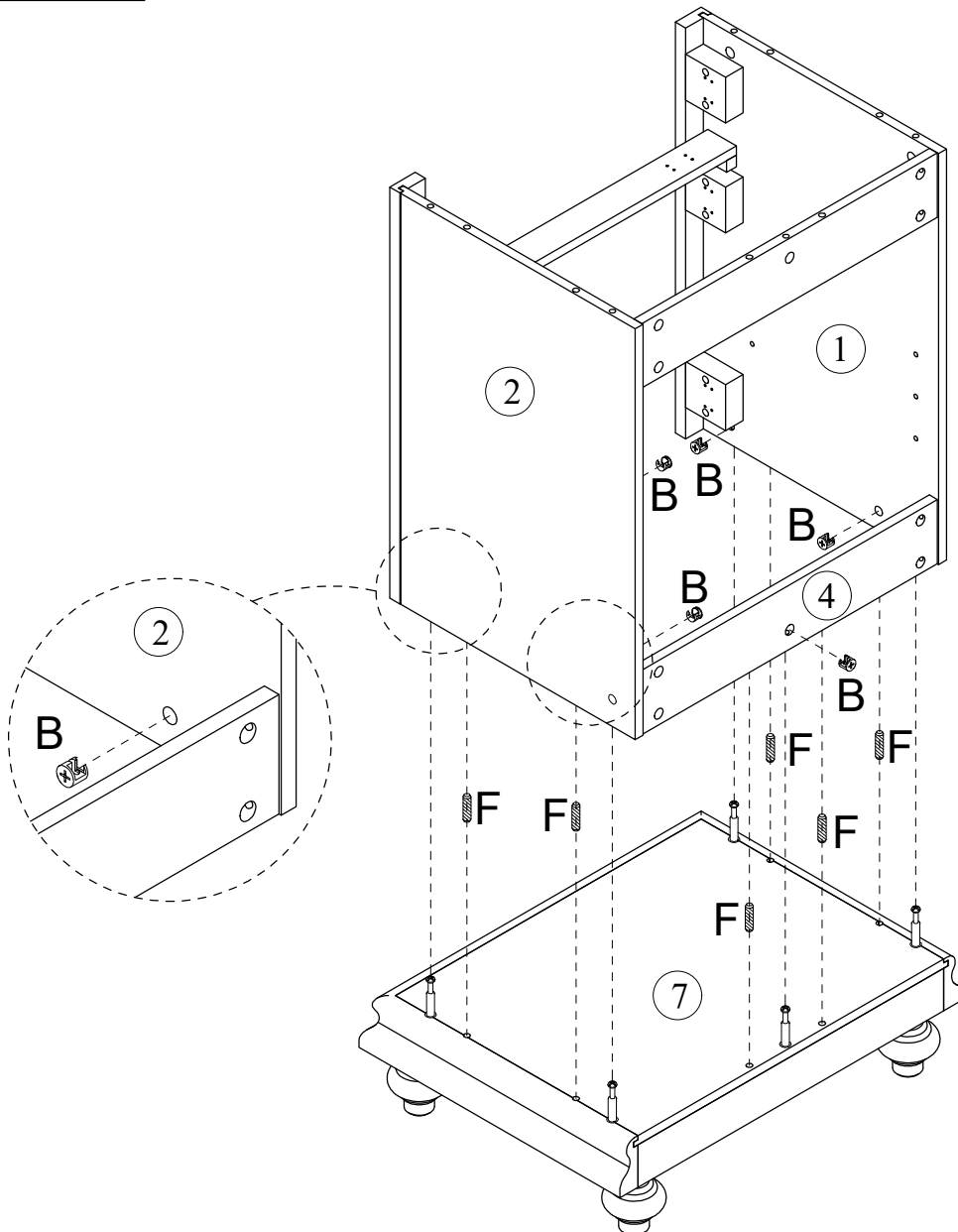

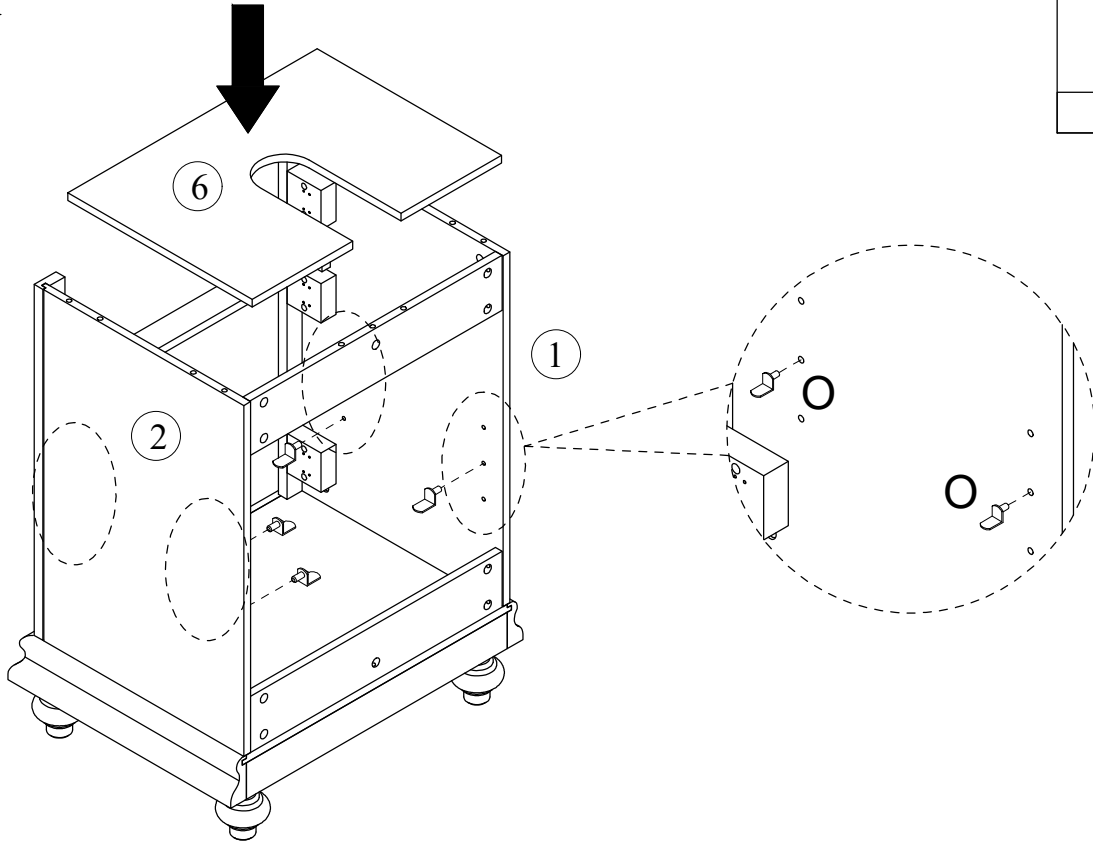

STEP: 6

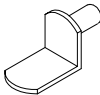



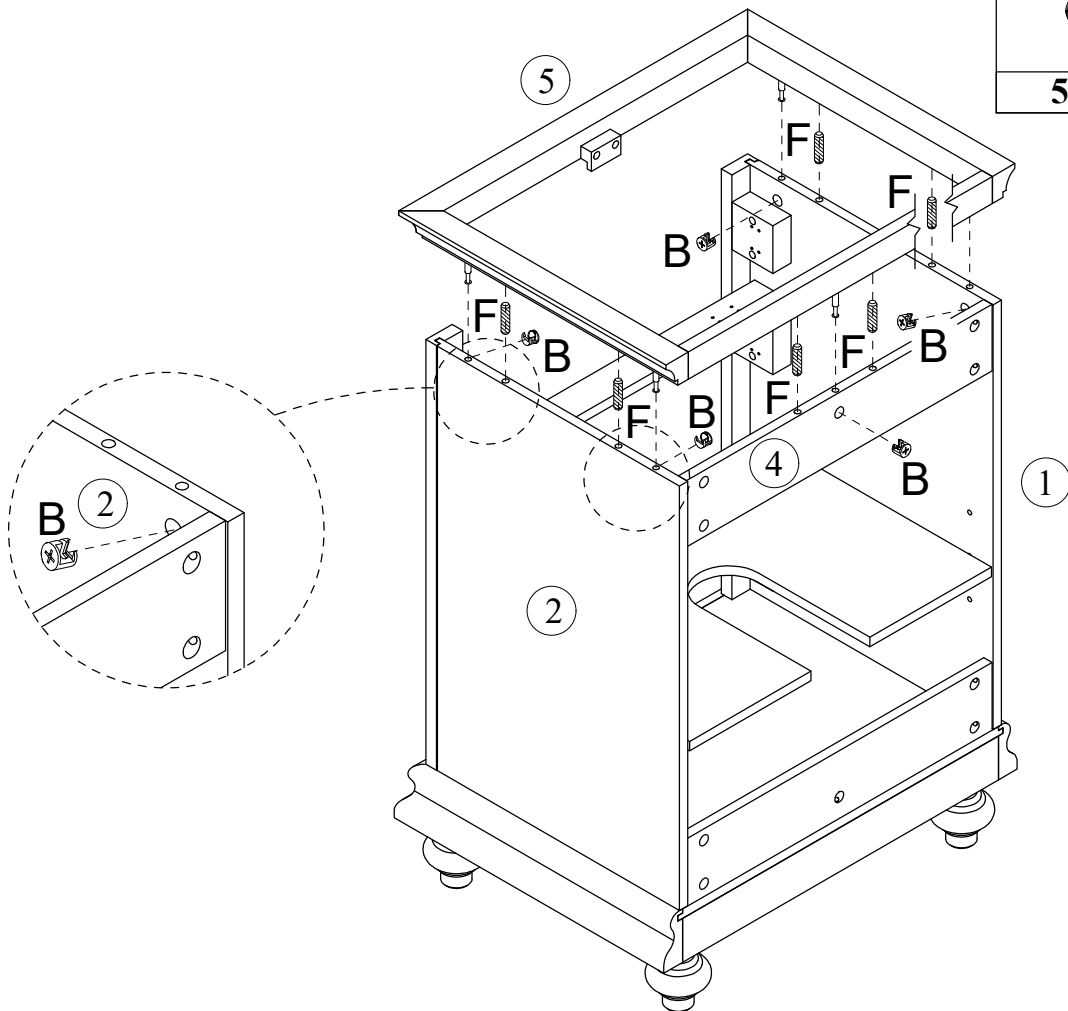

O	
4PCS	

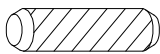
STEP: 7

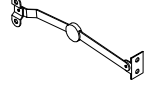
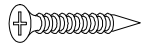
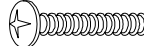

B		F	
5PCS		6PCS	

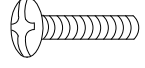
STEP: 8

G 	H 	I 	J 	K 
1PC	2PCS	2PCS	1PC	1PC
			M 	N 
			2PCS	4PCS

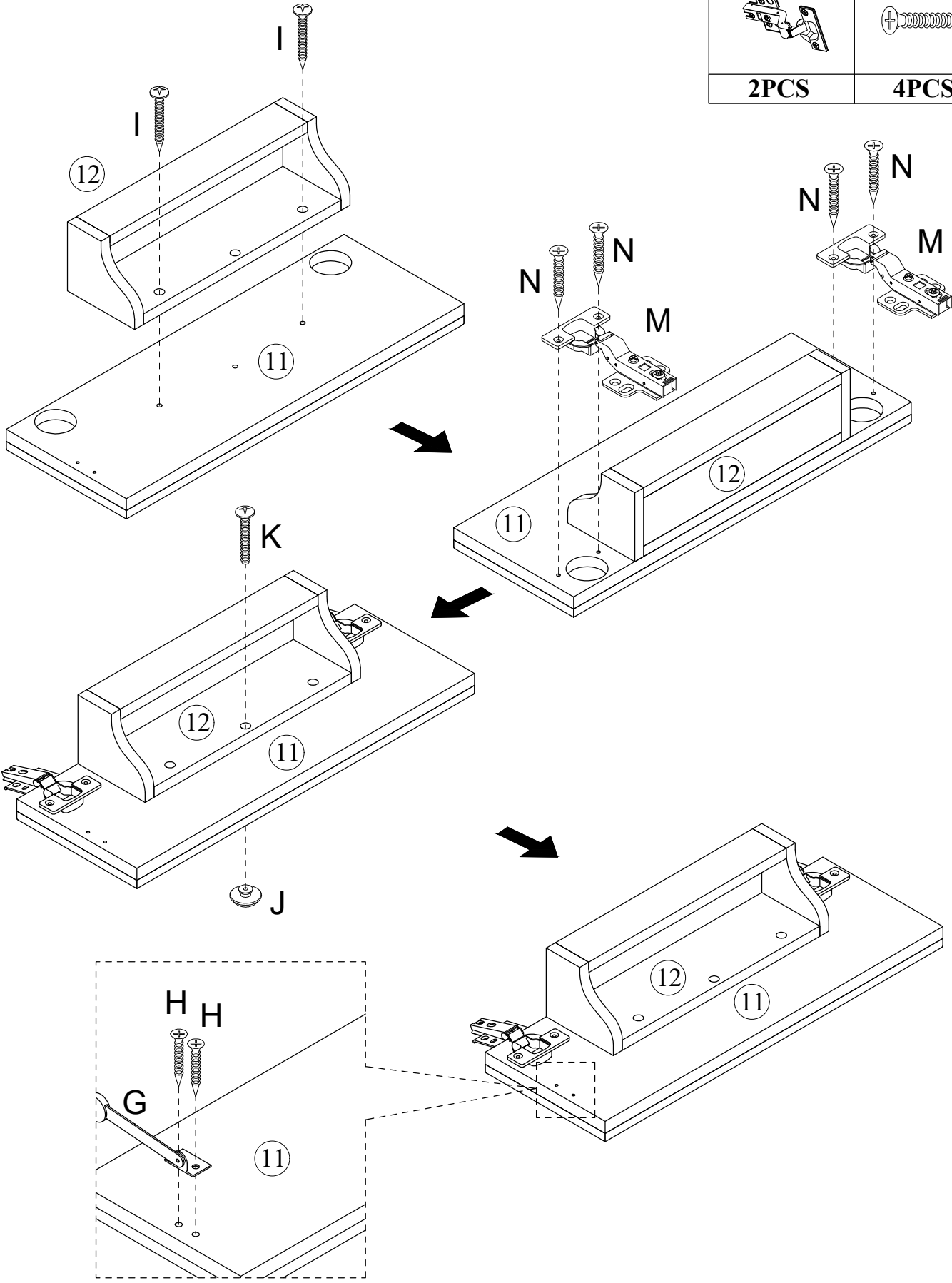

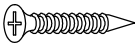
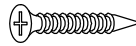

STEP: 9

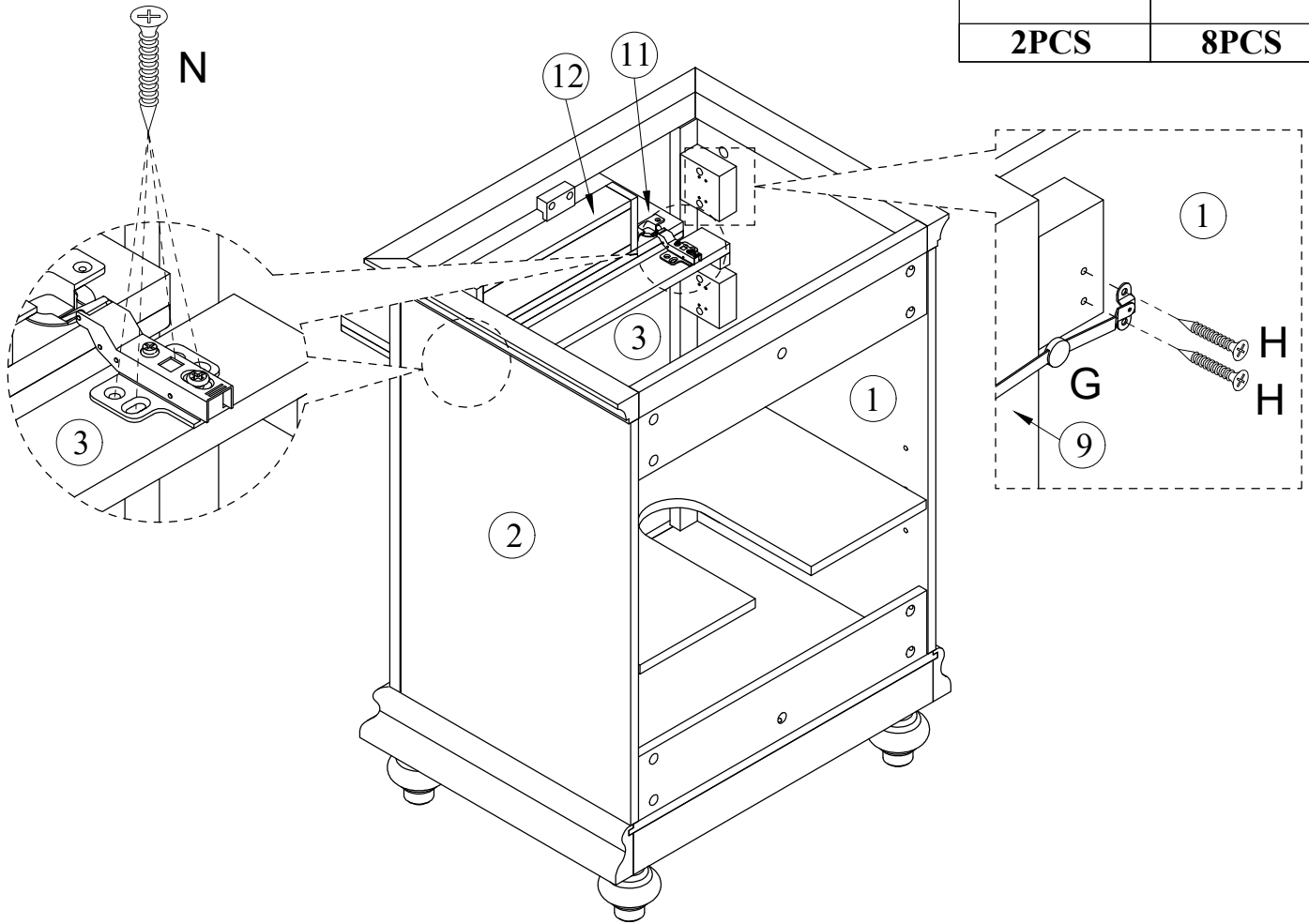
H	N
	
2PCS	8PCS



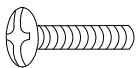

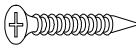
STEP: 10

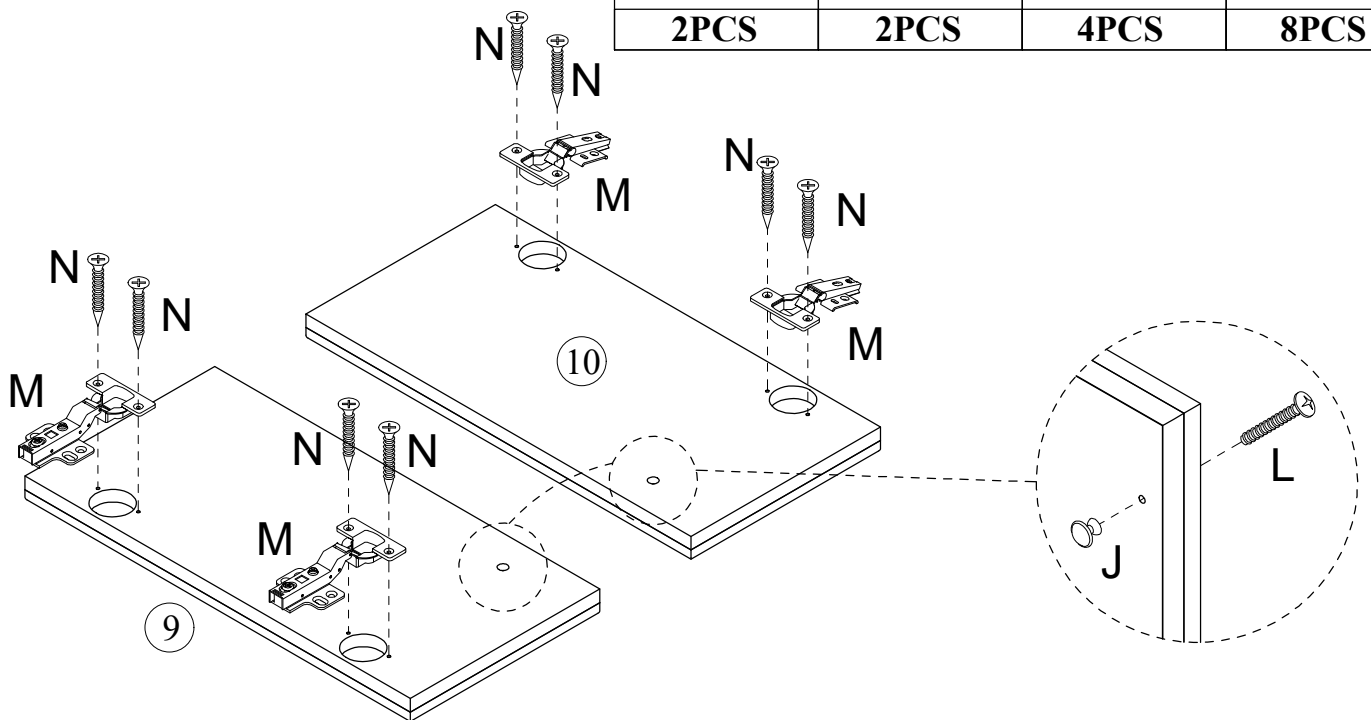
J	L	M	N
			
2PCS	2PCS	4PCS	8PCS

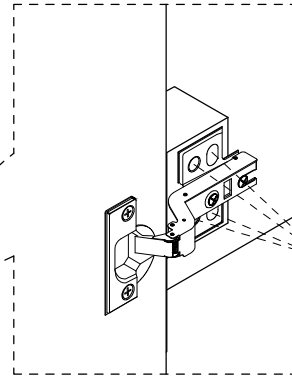
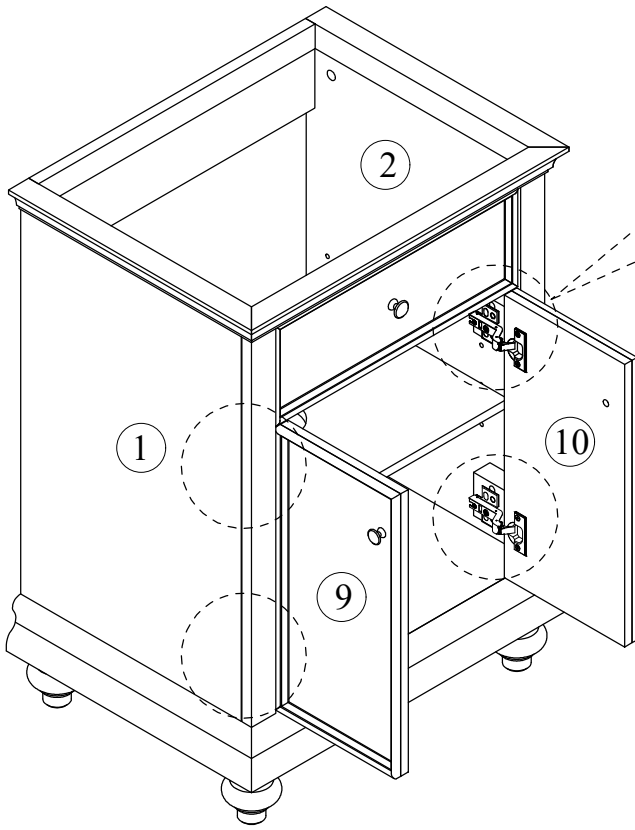

STEP: 11

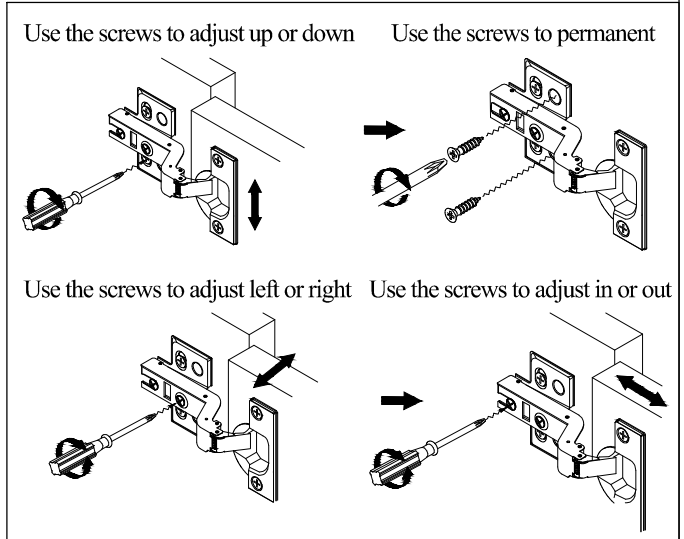

N

16PCS

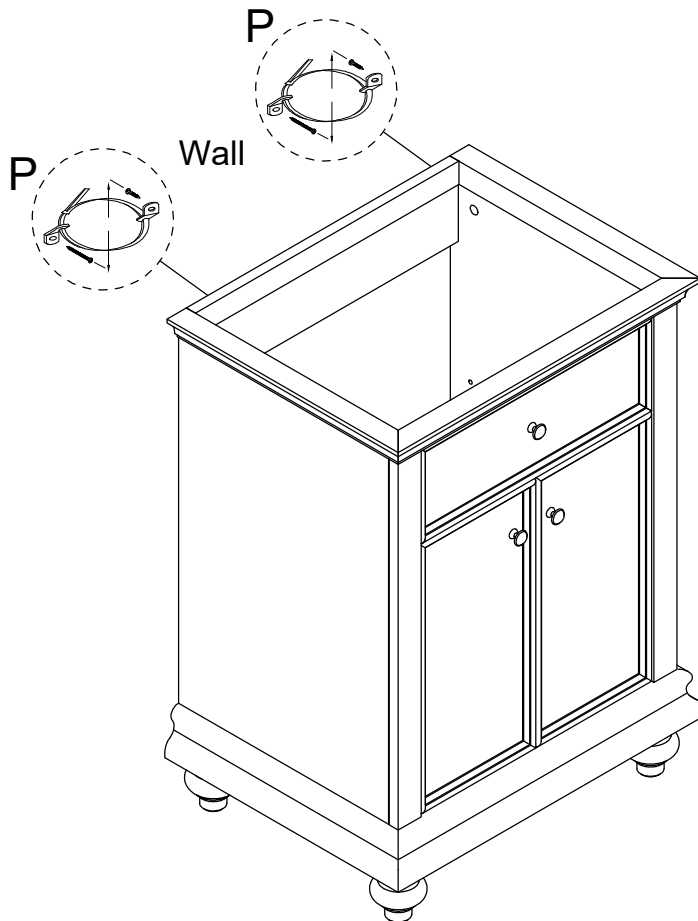

STEP: 12

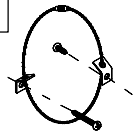

P

2 SETS

STEP: 13

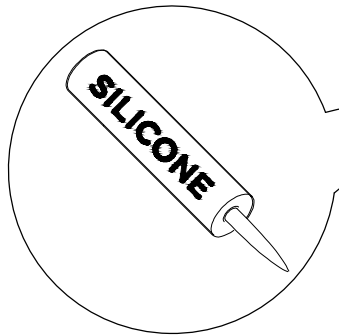
Install the sink on the cabinet with glue.
Let stand for 24 hours

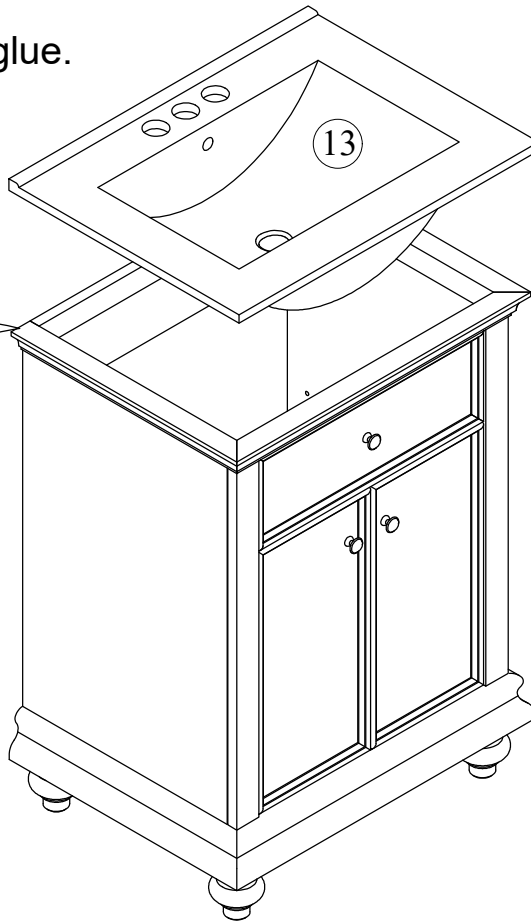

*Silicone glue is not included in the package to comply with safety regulations in certain shipping conditions.



STEP: 14

