

ASSEMBLY INSTRUCTIONS

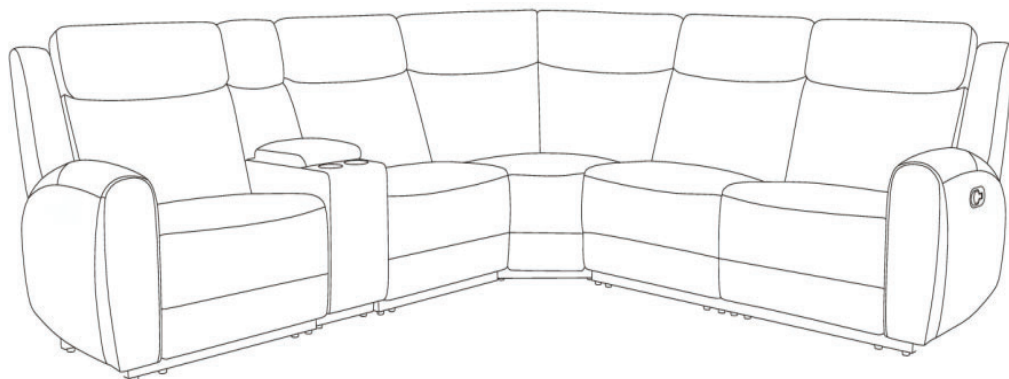

TOOLS REQUIRED



Allen Wrench

(Included)



Screwdriver

(Not Included)



2 - Persons
Recommended

ASSEMBLY RATING



EASY —————> DIFFICULT

The Assembly Rating is a 5-point system showing the level of effort needed to assemble a specific product.



CHECK BEFORE STARTING

Are you missing anything?

Double-check all parts, hardware and accessories listed are all accounted for.

Check out our Quick Tips!

We recommend reviewing the pre-assembly handouts. Even experts need a refresher now and then!

Should we send any replacements?

Are there any irregularities or flaws in the parts? We can send replacements!

Prep Time!

Please review the assembly instructions and all diagrams prior to assembling.

PRE ASSEMBLY INTRODUCTION

We understand building ready-to-assemble furniture can be a challenging experience for some. To help avoid confusion, we have provided some helpful tips that may speed up the process.

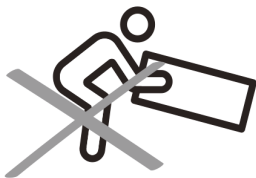

Teamwork

ALWAYS have at least two people to help with transporting and assembling the product to avoid potential injury and/or damage.

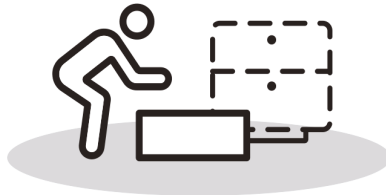
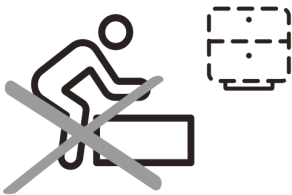

Suitable Location

Assembling near the area of the intended location is highly recommended.



Sufficient Space

Make sure you have enough space to move around during the assembly.



Avoid Scratches

Use cardboard, blankets or a carpeted area while assembling furniture to prevent to prevent scratches and damages.

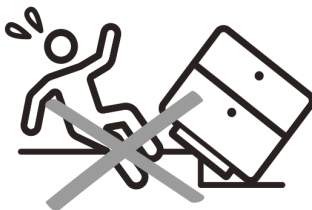

Flat Surface

Make sure the furniture rests on a flat and level surface with each leg evenly touching the floor.

ASSEMBLY AND CARE ADVICE



FAILURE TO FOLLOW THE GUIDELINES BELOW MAY RESULT IN INJURY AND/OR PROPERTY DAMAGE.



Position each part correctly and insert screws or bolts into their respective holes.

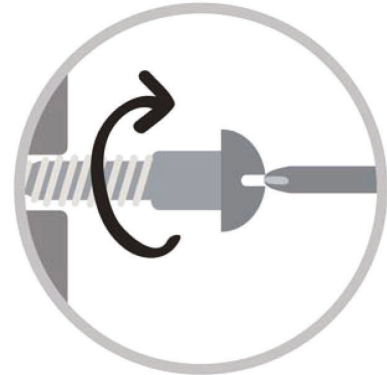

Turn clockwise to tighten and only tighten when step is completed or when instructed to do so.



Use the appropriate hand tools or power tools for assembly. Select steps, such as tightening screws and/or bolts, may require hand tools to avoid causing damage during assembly.



Save the instructions and store any supplied tools for later maintenance.



After two weeks, check and tighten any loose hardware and repeat again every six months thereafter.

IT IS THE USER'S RESPONSIBILITY TO MAINTAIN THE FURNITURE. THE HARDWARE MAY LOOSEN OVER TIME AND MAY CAUSE THE FURNITURE TO BE WOBBLY AND UNABLE TO SUPPORT ITS INTENDED WEIGHT CAPACITY. THIS MAY LEAD TO COLLAPSE AND MAY CAUSE SERIOUS INJURY.

SECTIONAL

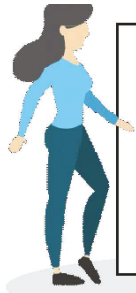

- Please keep instructions for future reference.
- Check the quantity and irregularity of parts and hardware before you start.

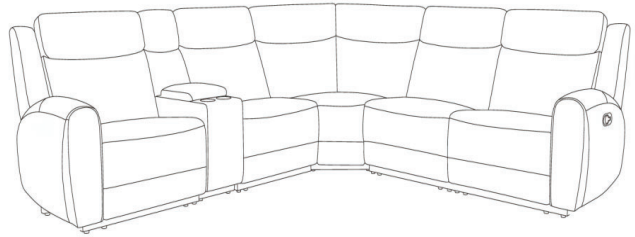

PARTS_LAF RECLINER 1.5

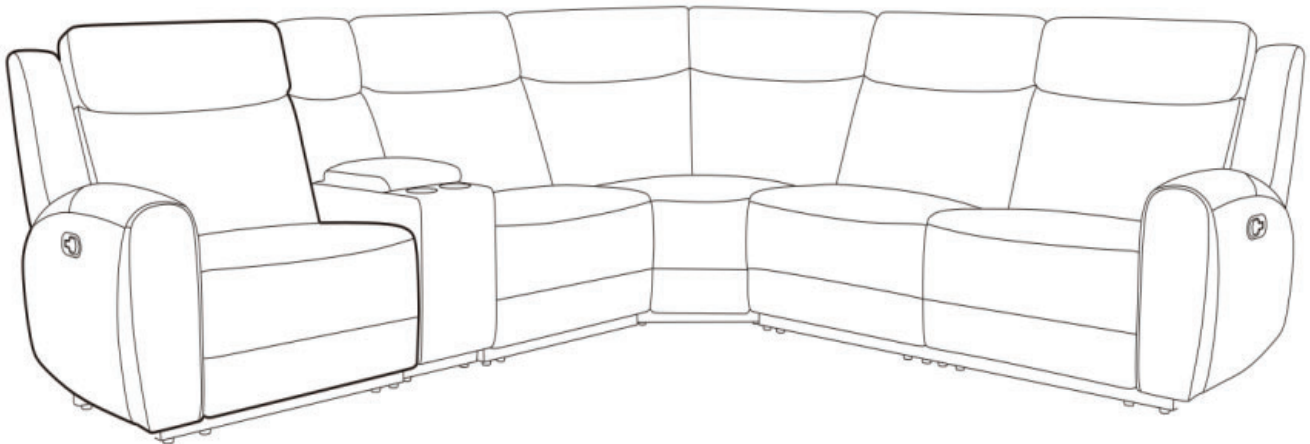

1

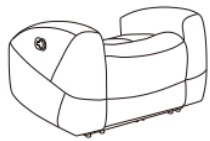

Body
1 pc.

2

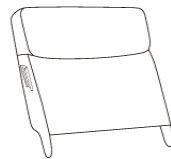

Backrest
1 pc.

3



LAF Wing
1 pc.

ASSEMBLY INSTRUCTIONS

- 1 There is a wing under seat. Remove it from under seat.

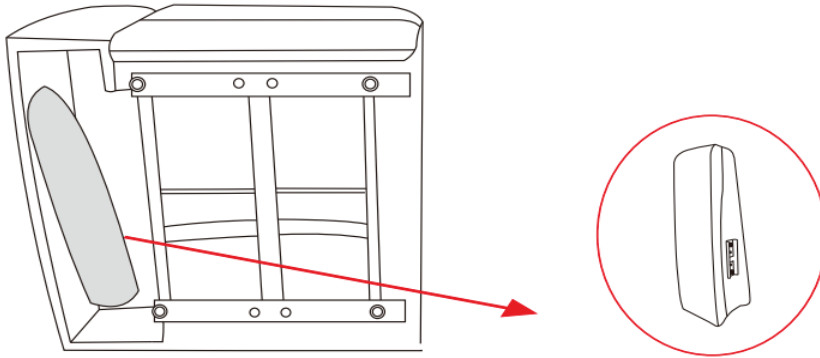

- 2 Install the Backrest into the Body by positioning the female metal receiver brackets over the male metal posts. Ensure that female metal receiver brackets on each side of the backrest line up with the seat metal posts. Push the female brackets down male posts simultaneously until each side is locked into place and an audible “click” is heard.

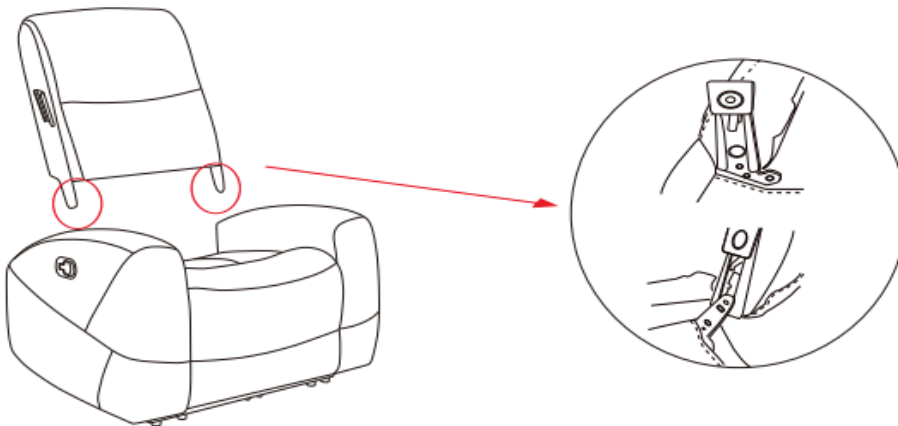

ASSEMBLY INSTRUCTIONS

3 Install the Wing by inserting brackets.

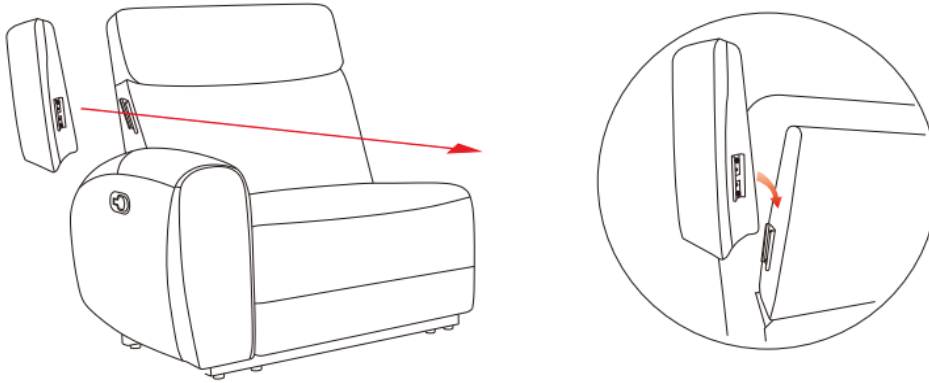

SECTIONAL

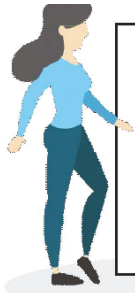

- Please keep instructions for future reference.
- Check the quantity and irregularity of parts and hardware before you start.

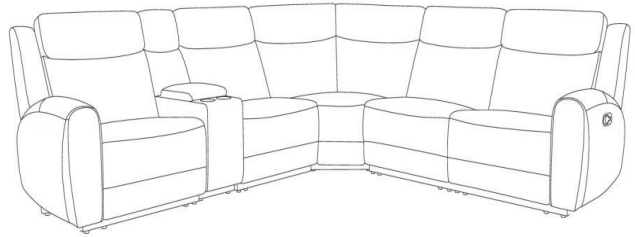

PARTS_CONSOLE

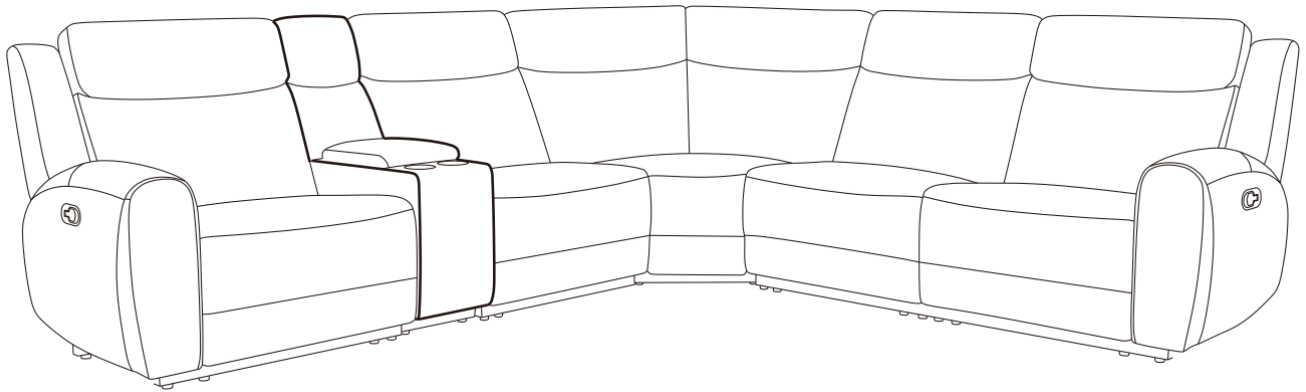

1

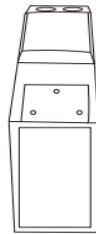

Body
1 pc.

2

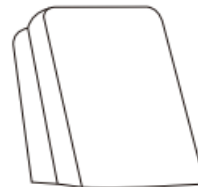

Backrest
1 pc.

ASSEMBLY INSTRUCTIONS

- 1 Please take out the Backrest from the bottom of the console.

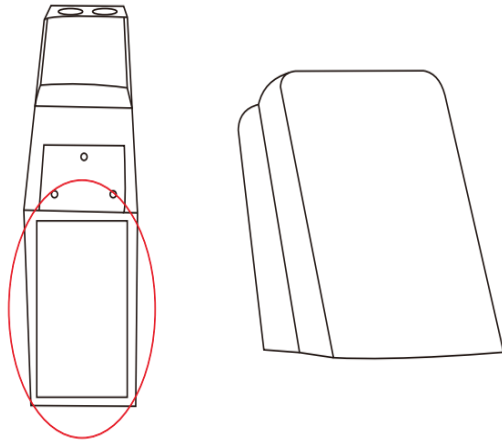

- 2 Align the holes of the Backrest and console, then tighten the screws in a clockwise direction.

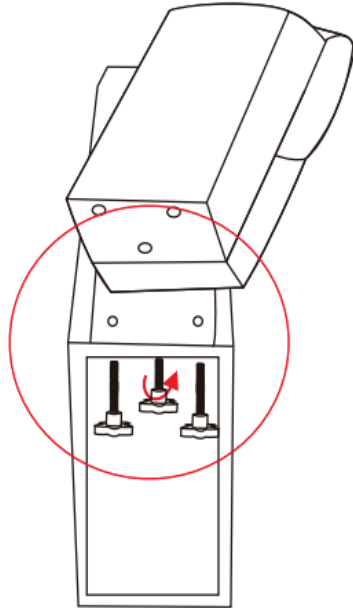

SECTIONAL

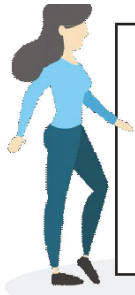

- Please keep instructions for future reference.
- Check the quantity and irregularity of parts and hardware before you start.

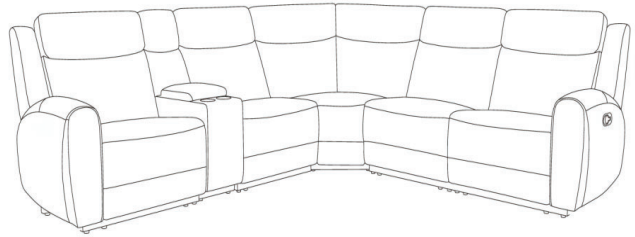

PARTS_ARMLESS CHAIR1.5

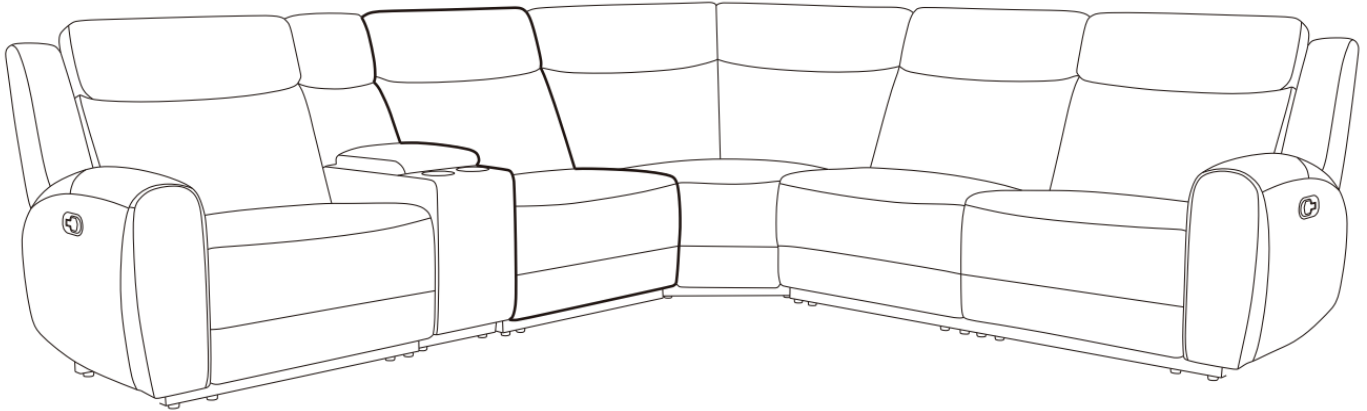

1



Body
1 pc.

2

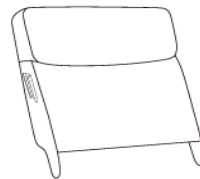

Backrest
1 pc.

ASSEMBLY INSTRUCTIONS

- 1 Install the Backrest into the Body by positioning the female metal receiver brackets over the male metal posts. Ensure that female metal receiver brackets on each side of the backrest line up with the seat metal posts. Push the female brackets down male posts simultaneously until each side is locked into place and an audible “click” is heard.

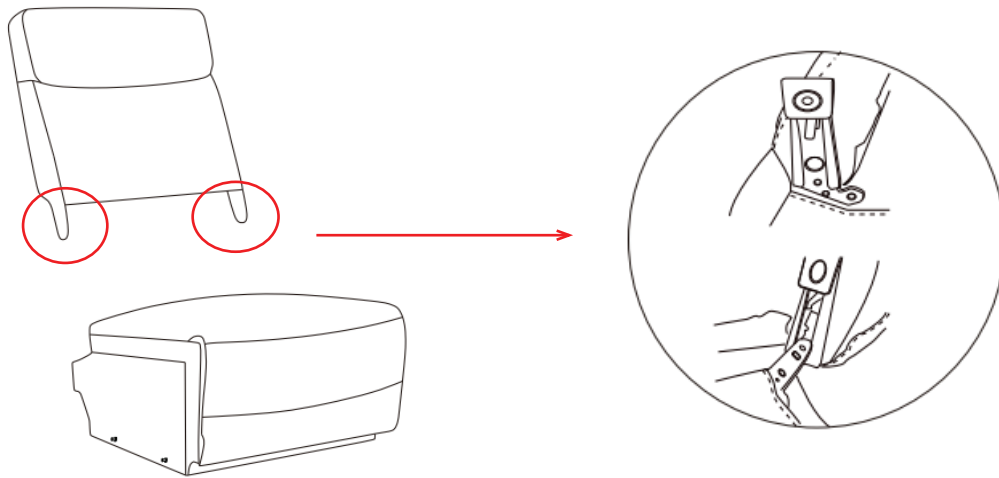

SECTIONAL

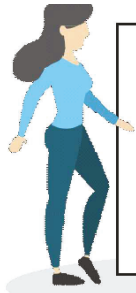

- Please keep instructions for future reference.
- Check the quantity and irregularity of parts and hardware before you start.

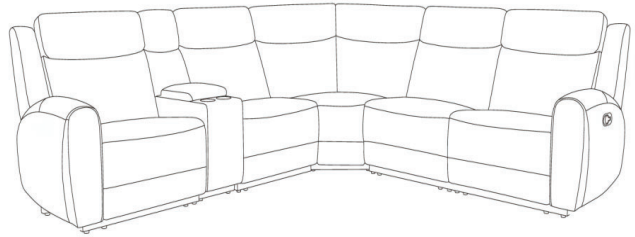

PARTS_CORNER WEDGE

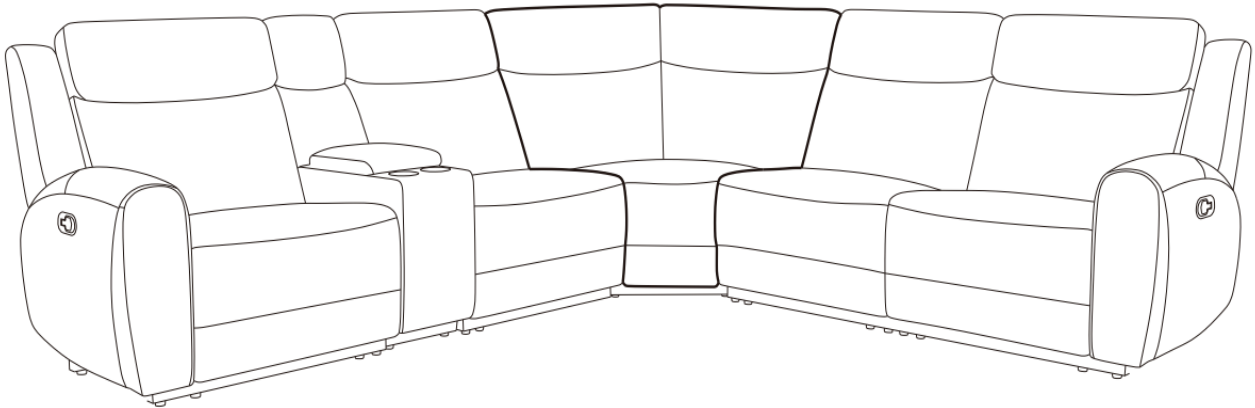

1

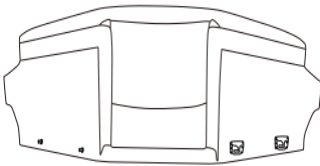

Body
1 pc.

2

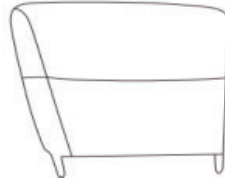

Left
Backrest
1 pc.

3



Right
Backrest
1 pc.

ASSEMBLY INSTRUCTIONS

- 1 Install the Backrests into the Body by positioning the female metal receiver brackets on each side of the backrest line up with the seatmetal posts. Push the female metal receiver brackets on each side of the backrest line up with the seatmetal posts. Push the female brackets down male posts simultaneously until each side is locked into place and an audible “click” is heard.

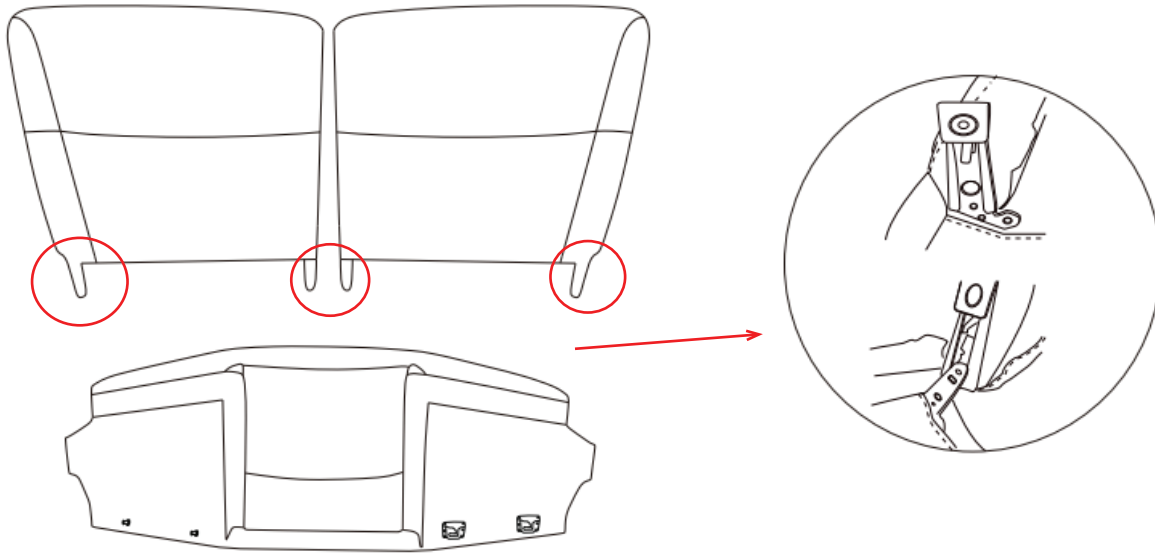

SECTIONAL

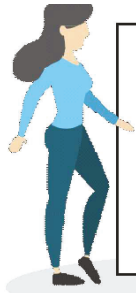

- Please keep instructions for future reference.
- Check the quantity and irregularity of parts and hardware before you start.

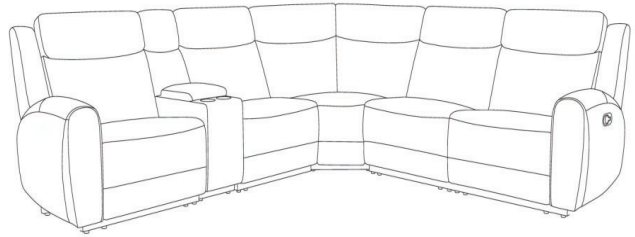

PARTS_ARMLESS CHAIR1.5

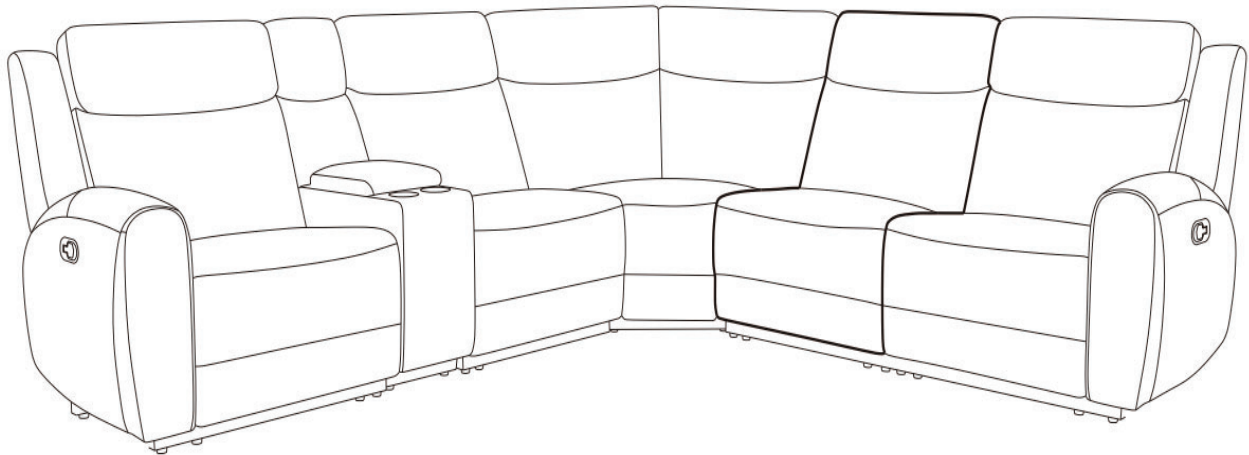

1

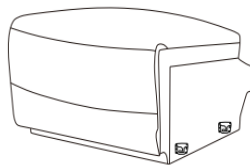

Body
1 pc.

2

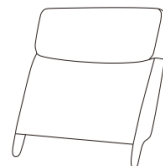

Backrest
1 pc.

ASSEMBLY INSTRUCTIONS

- 1 Install the Backrest into the Body by positioning the female metal receiver brackets over the male metal posts. Ensure that female metal receiver brackets on each side of the backrest line up with the seat metal posts. Push the female brackets down male posts simultaneously until each side is locked into place and an audible “click ” is heard.

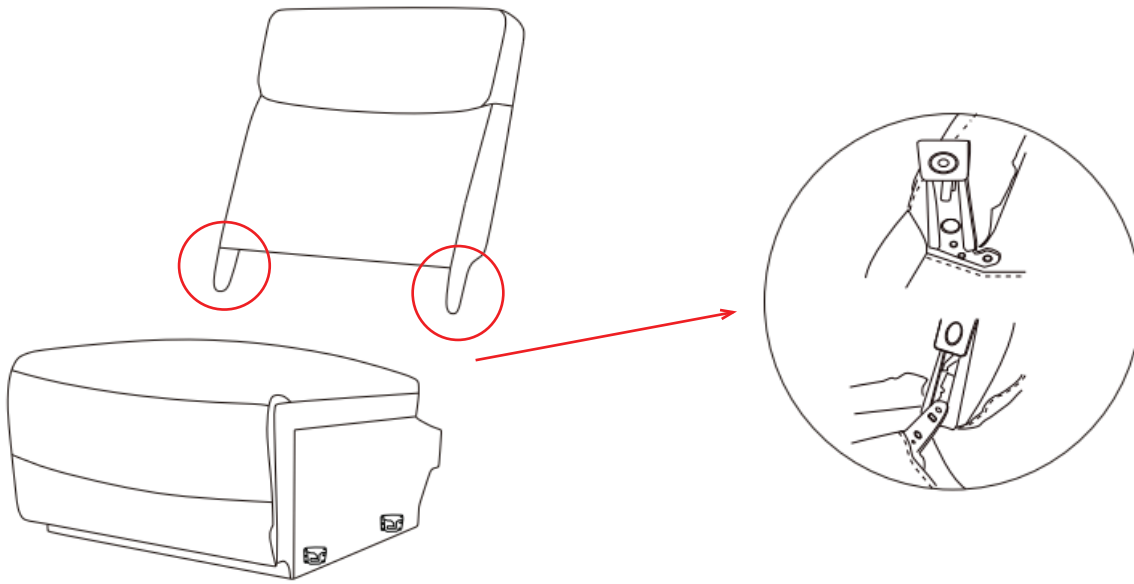

SECTIONAL

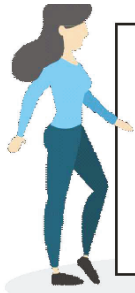

- Please keep instructions for future reference.
- Check the quantity and irregularity of parts and hardware before you start.

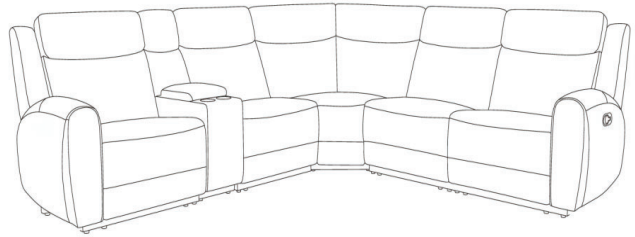

PARTS_RAF RECLINER1.5

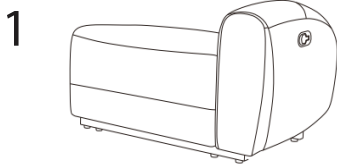
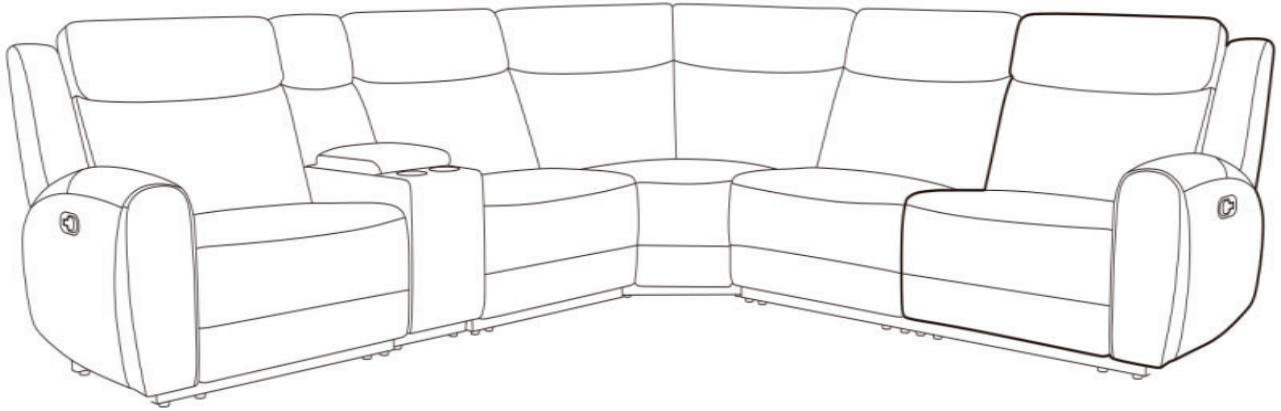

Body
1 pc.

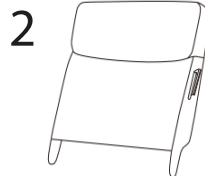

Backrest
1 pc.



RAF Wing
1 pc.

ASSEMBLY INSTRUCTIONS

- 1 There is a wing under seat. Remove it from under seat.

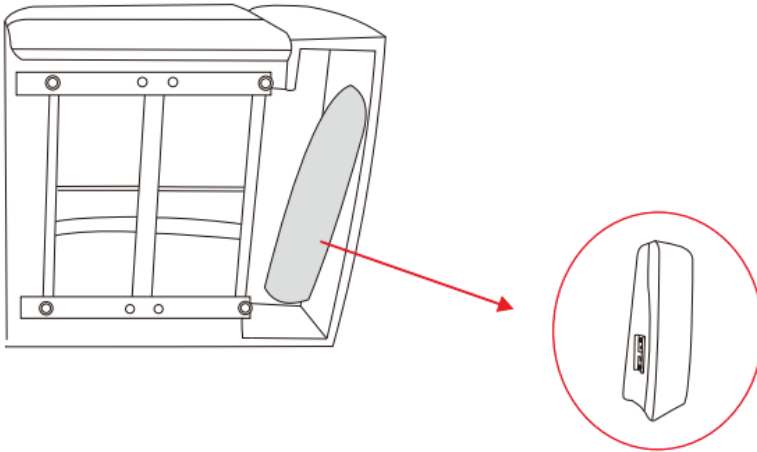

- 2 Install the Backrest into the Body by positioning the female metal receiver brackets over the male metal posts. Ensure that female metal receiver brackets on each side of the backrest line up with the seat metal posts. Push the female brackets down male posts simultaneously until each side is locked into place and an audible “click” is heard.

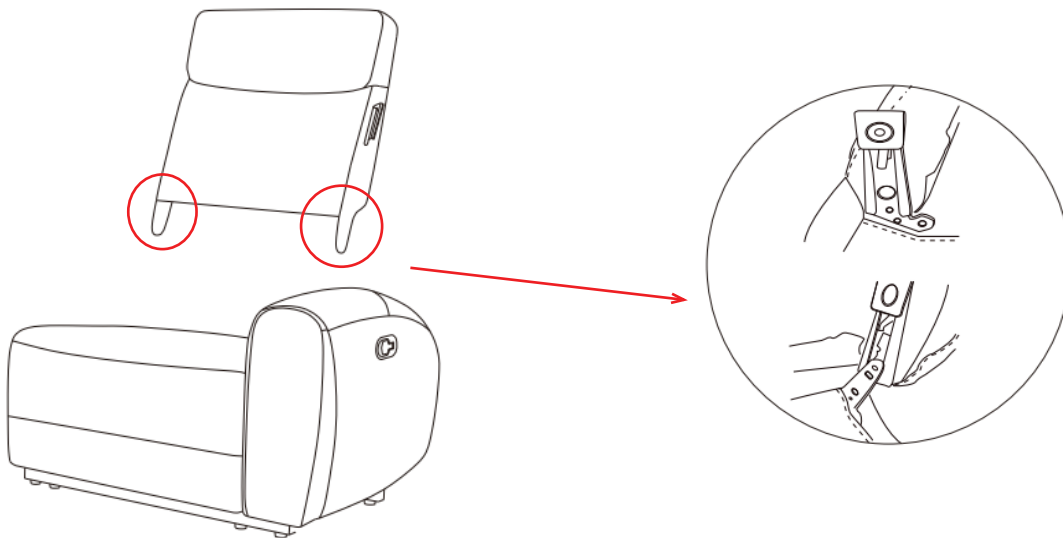

ASSEMBLY INSTRUCTIONS

- 3** Install the Wing by inserting brackets.

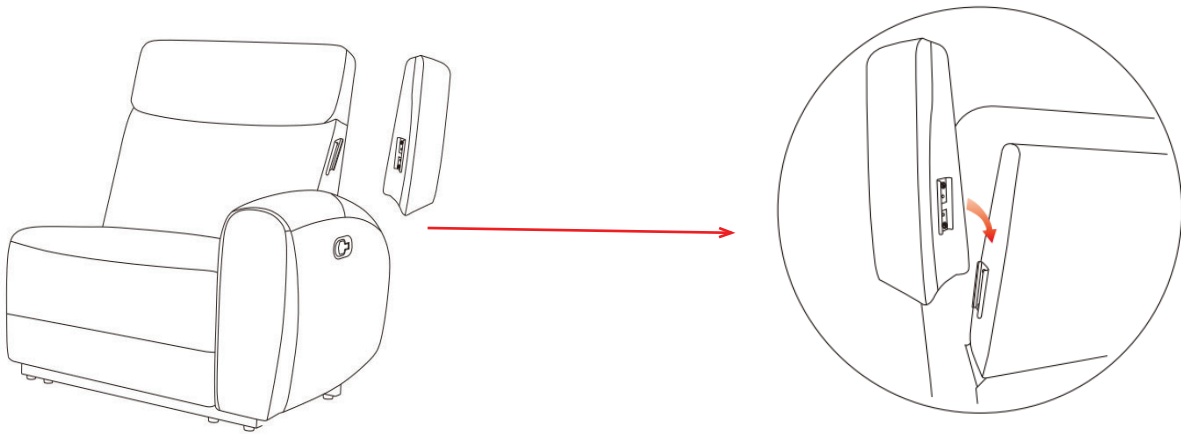

FINAL ASSEMBLY INSTRUCTIONS

- 1** Begin sectional connection by placing the piece #1 in desired location in room. Then start sectional connection by placing #2 into piece #1. Continue sectional connection with piece #3 thru #6 following the same method described above.

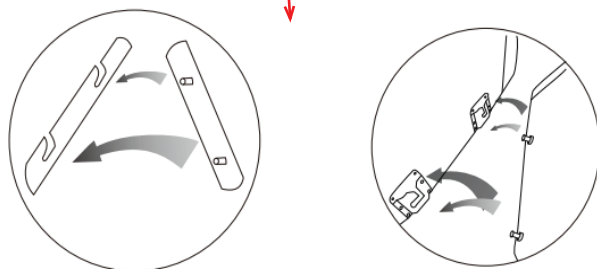
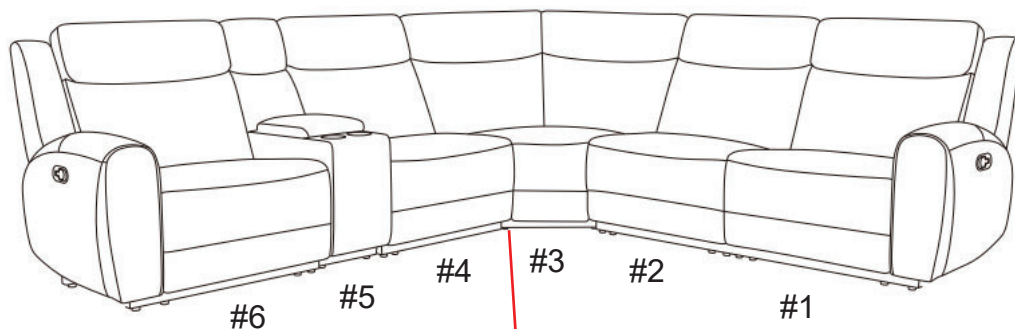

- 2** At last, attach all the flaps under backrests to the seat frame.

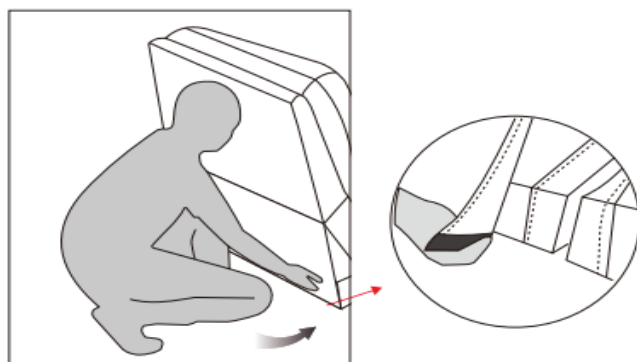

ASSEMBLY COMPLETED



Please ensure the furniture rests on an even and flat surface. If the product wobbles or feels loose, double-check all bolts and/or screws are properly tightened and secured.

Keep this handy!

Please retain this instruction manual and any order-related information for future reference.

Lift, don't drag!

To avoid damage to product please always LIFT the product when transporting or adjusting the placement.

This product is intended for RESIDENTIAL USE ONLY and not for commercial use.