

## CHAIR/SOFA

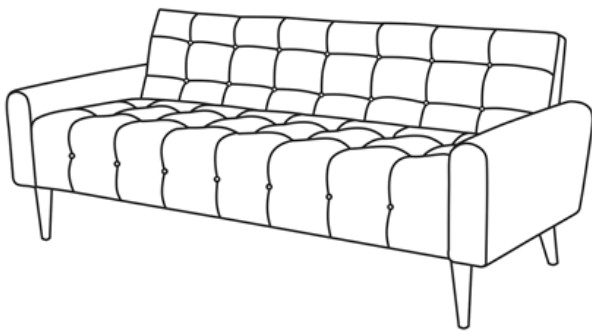



Thank you for purchasing this chair/sofa!

Before you start, here is some helpful advice:

1. We suggest you spend a short time reading through this leaflet and then follow the simple step by step instructions.
2. Owing to the size and weight of the chair/sofa, we recommend that it is assembled by two adults, on a carpeted or padded area, in the room that it is intended for. Approximate assembly time: 30 minutes.
3. Please do not use any tools other than those provided or recommended in these instructions.
4. Please do not throw away any of the packaging or instructions until you have checked all the components and hardware and the furniture is fully assembled.
5. Assemble all components loosely until advised to tighten. Depending on use, it may be necessary to tighten the components from time to time, so please save the tools that have been provided.
6. Please keep all pieces out of reach of small children.

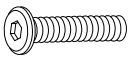

### Hardware:

A		Bolt M6x30mm	x 12
B		Spring Washer M6	x 12
C		Flat Washer M6	x 12
D		Allen Wrench	x 1

### Component:

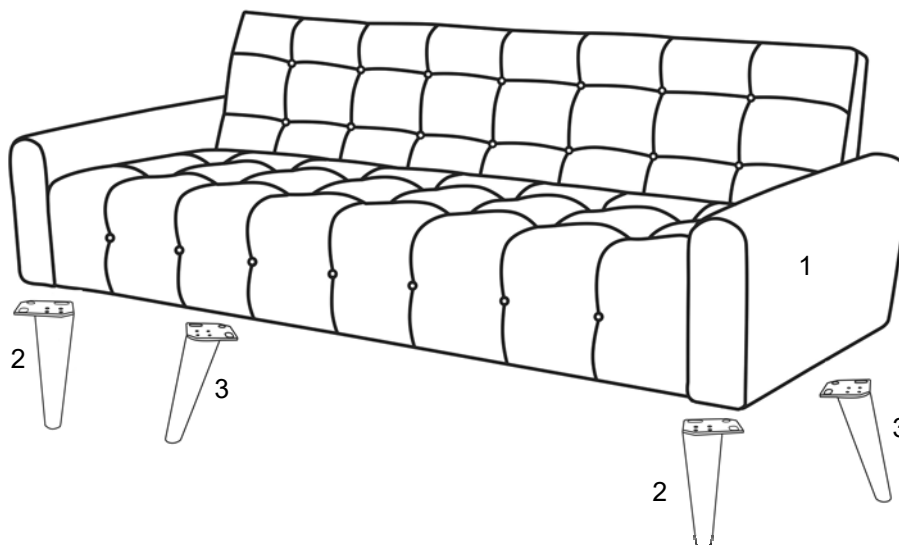

1	Chair/Sofa Body	x1	2	Front Leg	x2	3	Back Leg	x2
---	-----------------	----	---	-----------	----	---	----------	----



## CHAIR/SOFA

---

### STEP 3:

Carefully turn over the assembled chair/sofa.

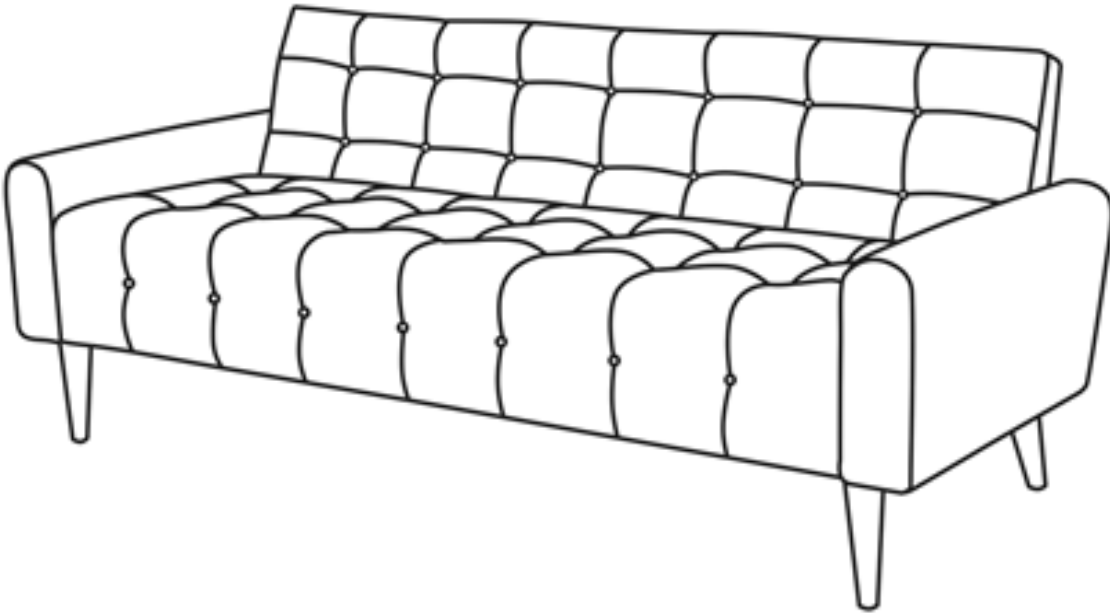

---

Assembly is completed. Your chair/sofa is ready to be enjoyed now!