

2 Doors w/Drawer Glass Cabinet

Assembly Instruction

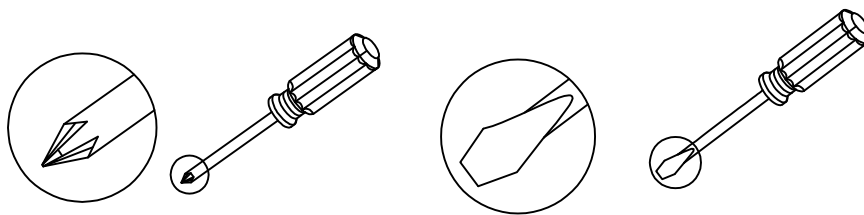

ASSEMBLY TOOLS REQUIRED (NOT INCLUDED)





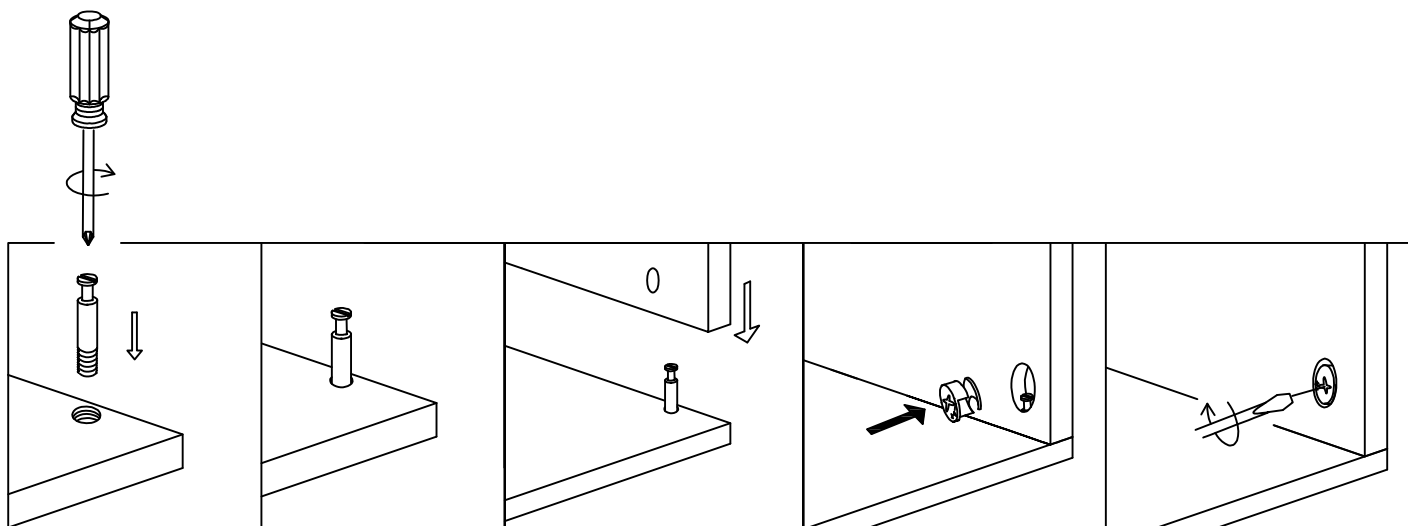



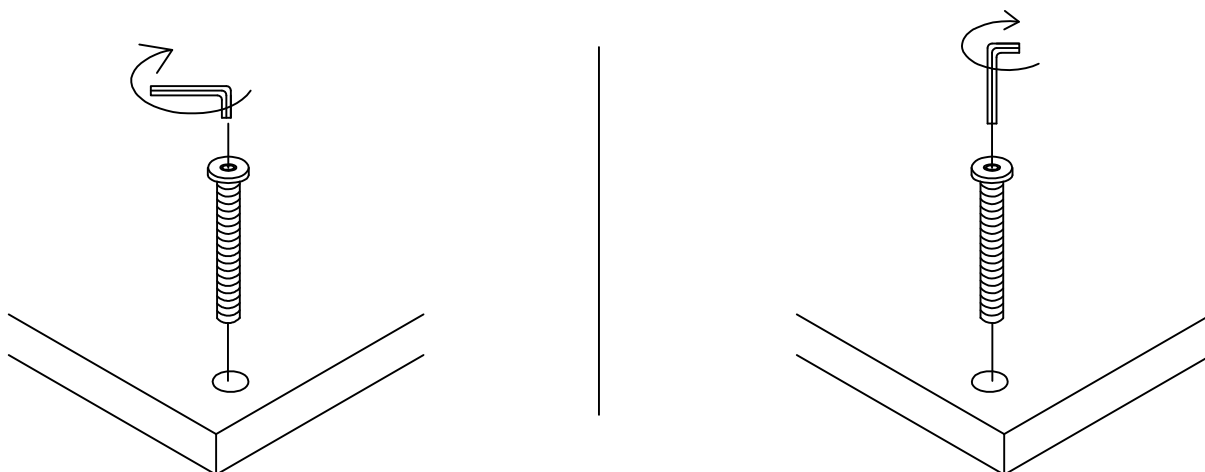



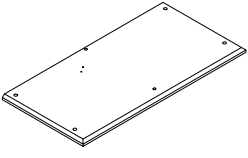
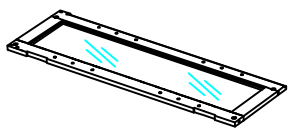
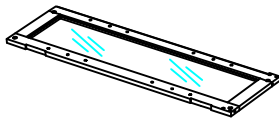
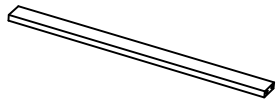

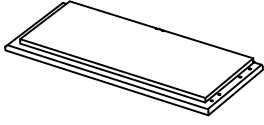
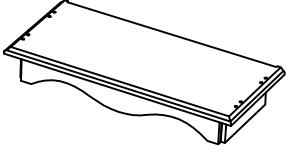
HIDDEN CONNECTOR..... ASSEMBLY TECHNIQUES

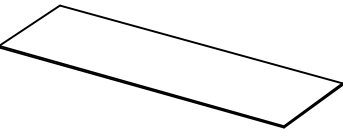
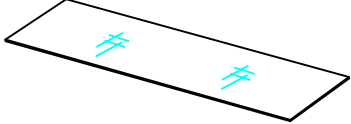
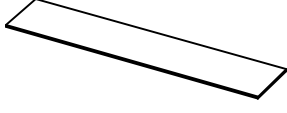
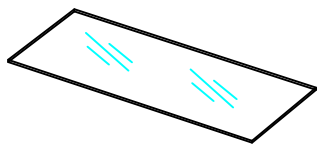
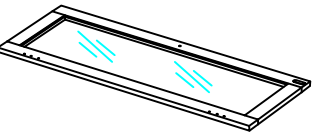
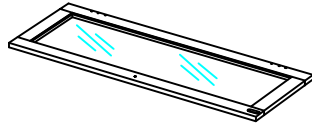
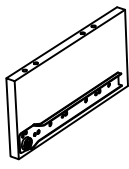
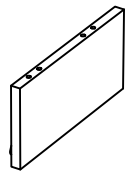











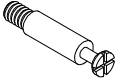



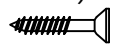





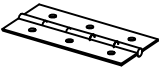



MACHINE SCREW INSTALLATION PROCEDURE

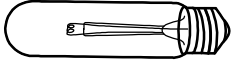



Parts List

<p>1: Top Panel -1Pc</p> 	<p>2: Upper Left Side -1Pc</p> 	<p>3: Upper Right Side -1Pc</p> 	<p>4: Upper Top Front Crosspiece -1Pc</p> 
<p>5: Upper Top Back Crosspiece -1Pc</p> 	<p>6: Upper Bottom Panel -1Pc</p>  <p>Lower Back Pole</p>	<p>7: Lower Bottom Frame -1Pc</p> 	<p>8: Upper Top Back Crosspiece -1Pc</p> 
<p>9: Upper Top Back Panel -2Pcs</p> 	<p>10: Upper Top Back Mirror -2Pcs</p> 	<p>11: Lower Bottom Back Panel -1Pc</p> 	<p>12: Glass Shelves -2Pcs</p> 
<p>13: Left Door -1Pc</p> 	<p>14: Right Door -1Pc</p> 	<p>15: Lower Left Panel -1Pc</p> 	<p>16: Lower Right Panel -1Pc</p> 
<p>17: Drawre Front Side -1Pc</p> 	<p>18: Lower Back Side -1Pc</p> 	<p>19: Drawre Left Side -1Pc</p> 	<p>20: Drawre Right Side -1Pc</p> 
<p>21: Drawer Bottom Panel -1Pc</p> 	<p>22: Front Legs -2Pcs</p> 	<p>23: Back Legs -2Pcs</p> 	

Hardware List

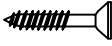

<p>A: Camlock bolt 12Pcs (Extra 1)</p> 	<p>B: Camlock 12Pcs (Extra 1)</p> 	<p>C: Wood Dowel 14Pcs (Extra 1)</p> 	<p>D: Back screw 34Pcs (Extra 2)</p>  <p style="text-align: center;">ø3X12mm</p>	<p>E: Flat head Screw 6 Pcs (Extra 1)</p>  <p style="text-align: center;">ø3X12mm</p>
<p>F: Machine Screw 16Pcs (Extra 1)</p>  <p style="text-align: center;">ø1/4"x1 1/2"</p>	<p>G: Lock washer 8Pcs (Extra 1)</p> 	<p>H: Flat washer 8Pcs (Extra 1)</p> 	<p>I: Shelf support 8Pcs (Extra 1)</p> 	<p>J: Banana Lamp 1Pc</p> 
<p>K: Hinge 4Pcs</p> 	<p>L: Wood Screw 24Pcs (Extra 1)</p>  <p style="text-align: center;">ø3X12mm</p>	<p>M: Allen Wrench 1Pc</p> 	<p>N: Safety Wall Strap 1Pc</p> 	<p>O: Plastic Anchor 1Pc</p> 
<p>P: Mounting Screw 1Pc</p>  <p style="text-align: center;">ø4x38mm</p>	<p>Q: Washer 2Pcs</p> 	<p>R: Lamp Bulb 1Pc</p>  <p style="text-align: center;">120V 4W Type T Bulb</p>	<p>S: Connecting slice 2Pcs</p> 	<p>T: Machine screw 3Pcs</p>  <p style="text-align: center;">ø5/32x3/4"</p>
<p>U: Drawre Screw 8Pcs (Extra 1)</p>  <p style="text-align: center;">ø4x25mm</p>	<p>V: Metal plate 3Pcs</p> 	<p>W: Handle 3Pcs</p> 	<p>X: Back screw 1Pc</p>  <p style="text-align: center;">ø3X15 mm</p>	<p>Y: Wood Dowel 4 Pcs</p> 

STEP 1

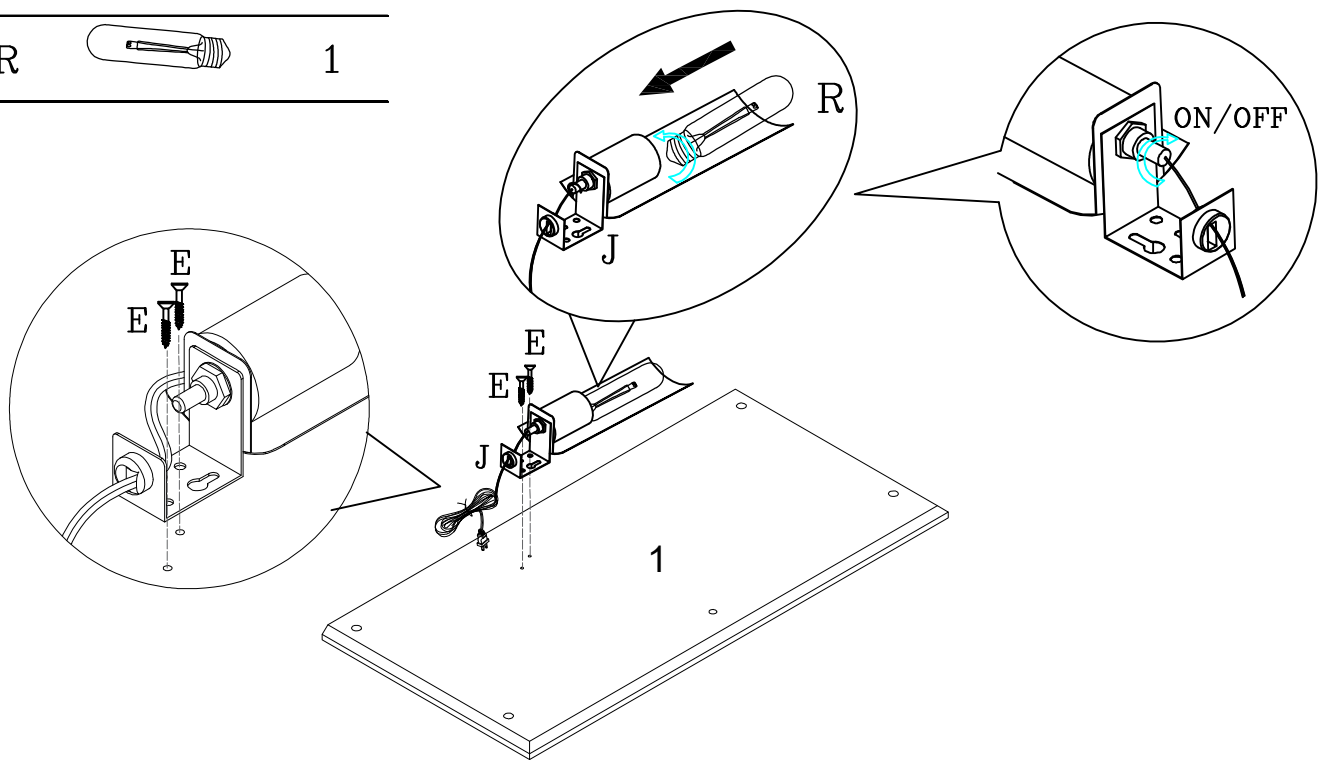
E		2
J		1
R		1





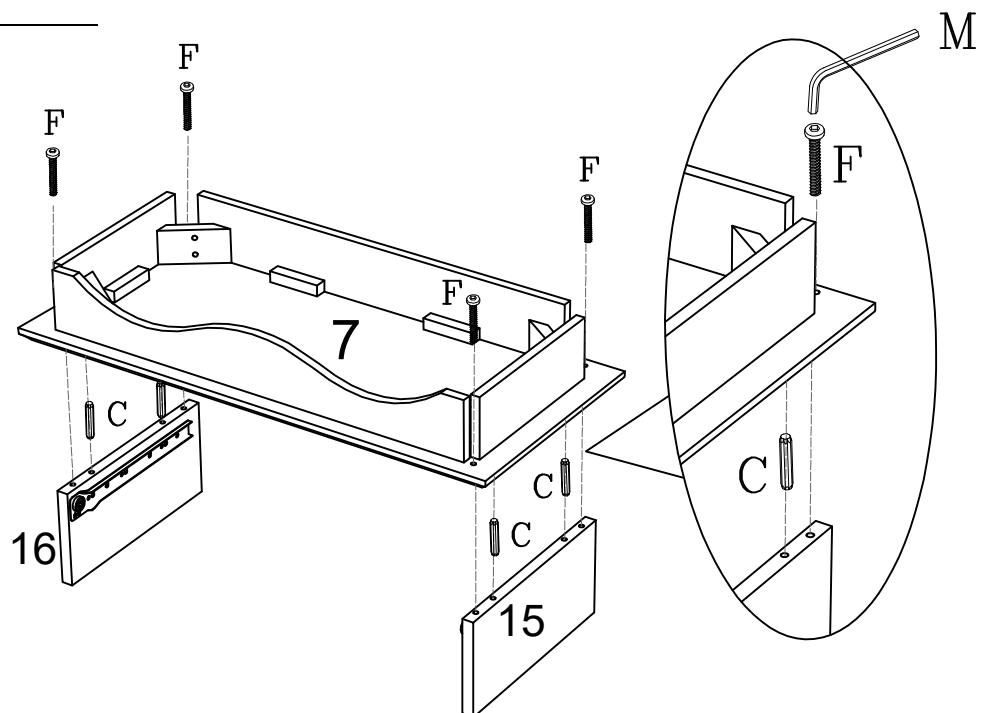

STEP 2

C		4
F		4
M		1



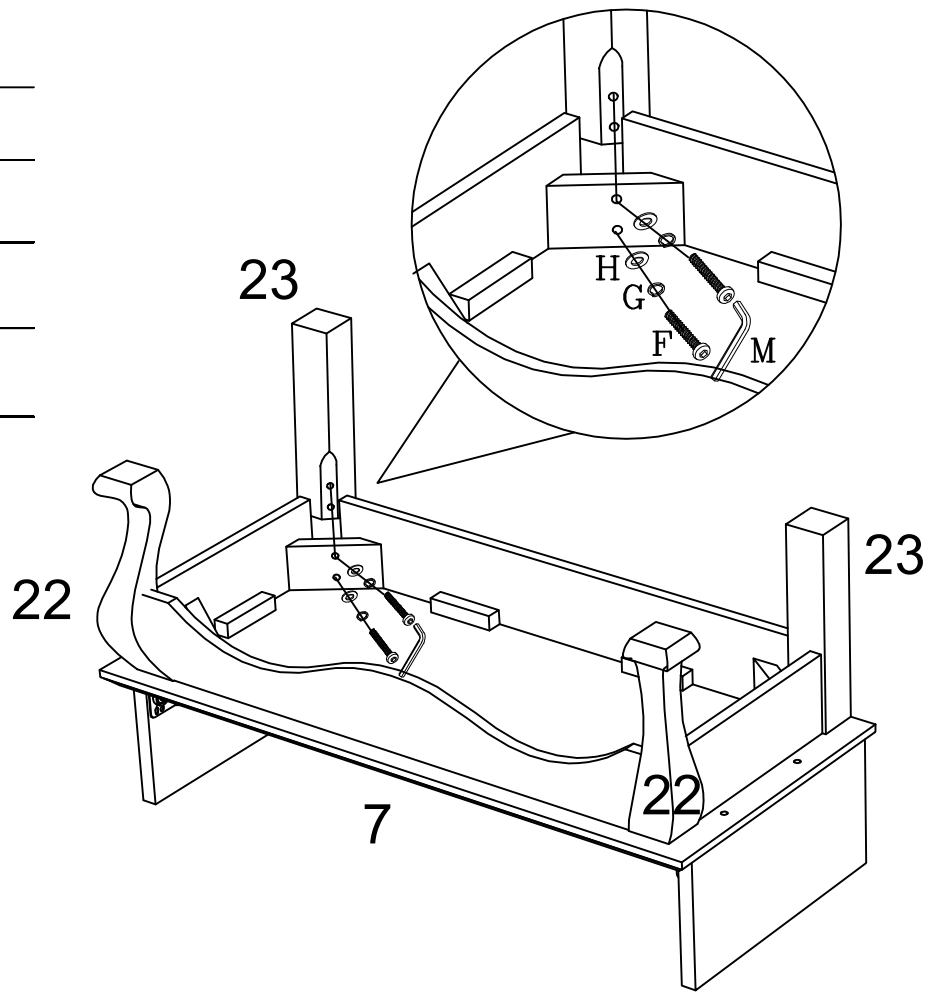

STEP 3

F		8
G		8
H		8
M		1



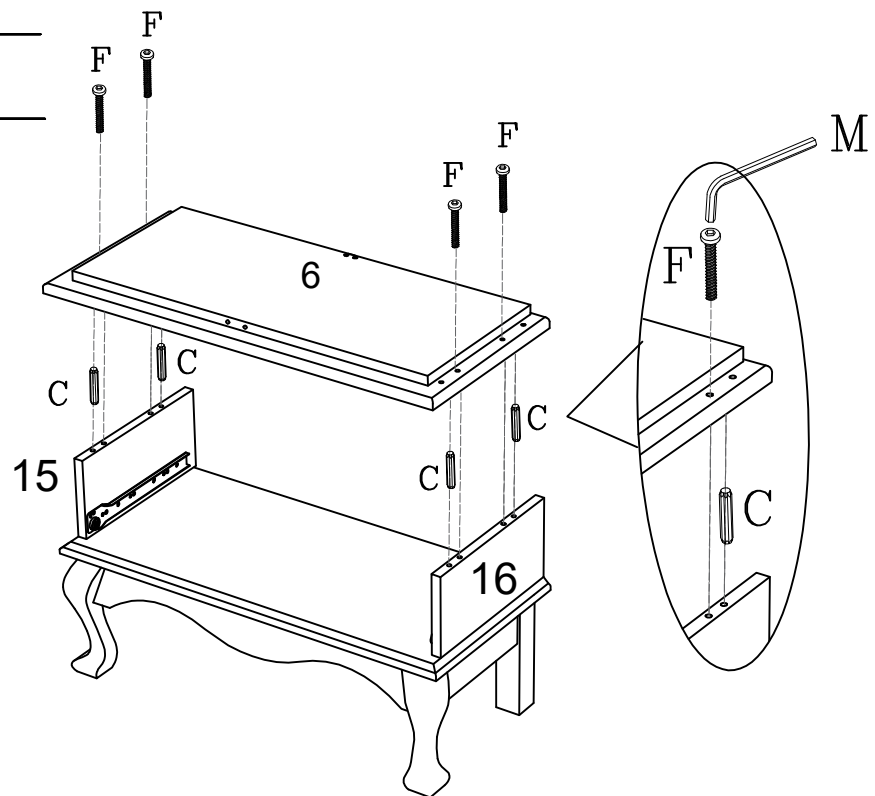

STEP 4

C		4
F		4
M		1



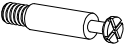

STEP 5

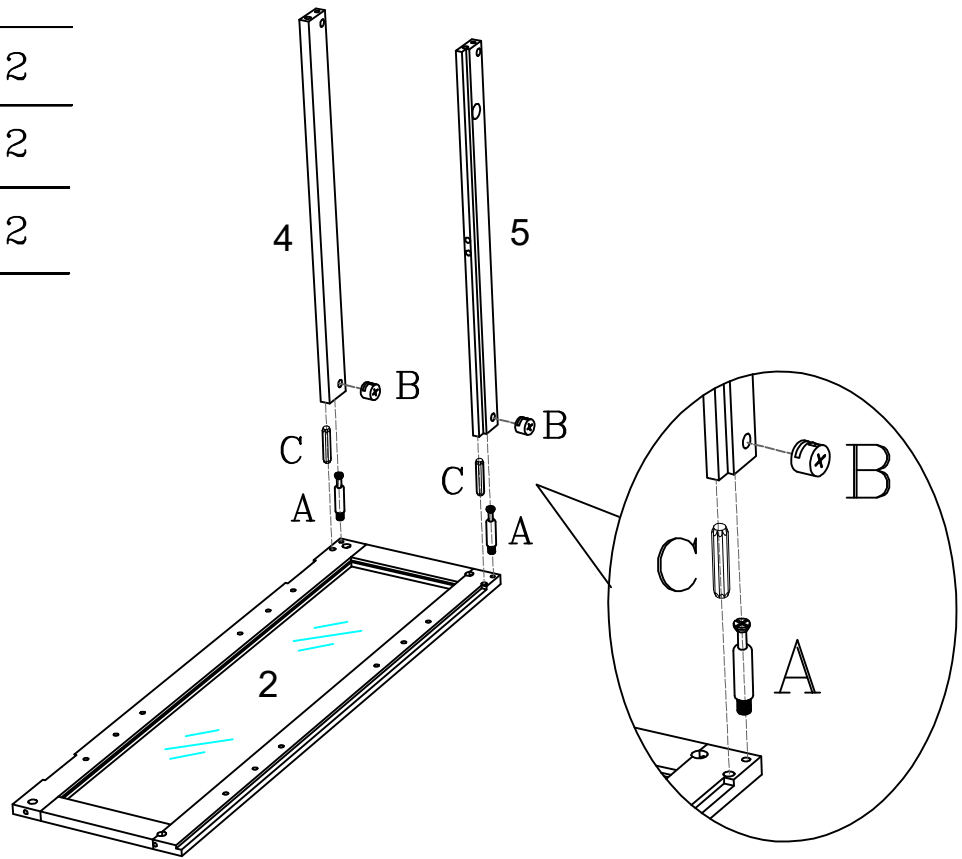
A		2
B		2
C		2



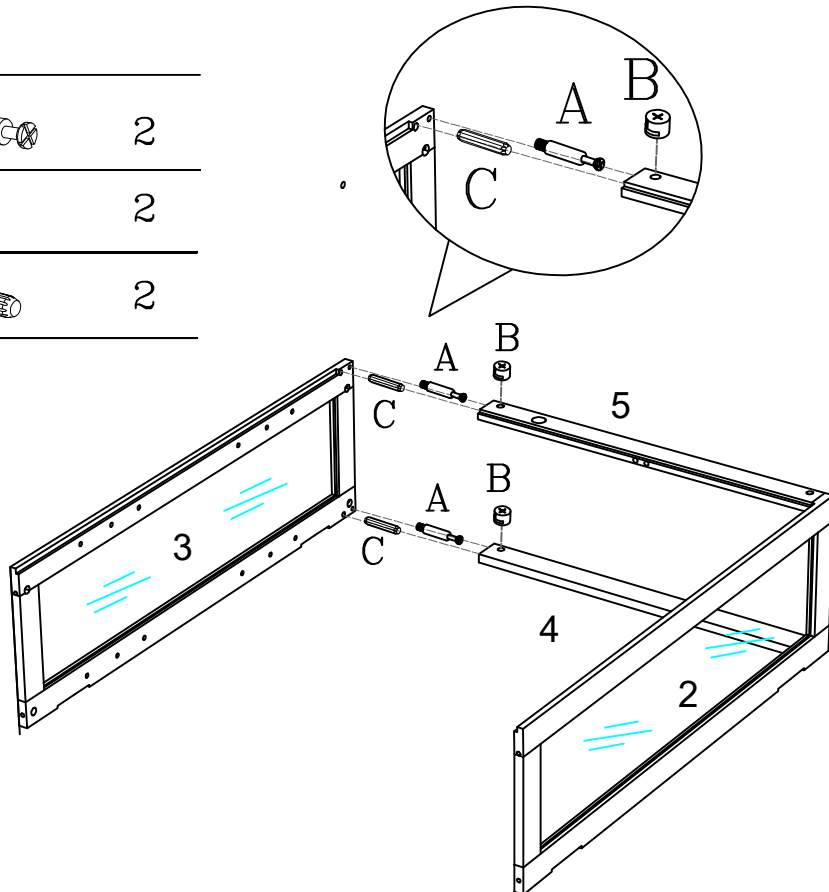

STEP 6

A		2
B		2
C		2



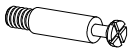

STEP 7

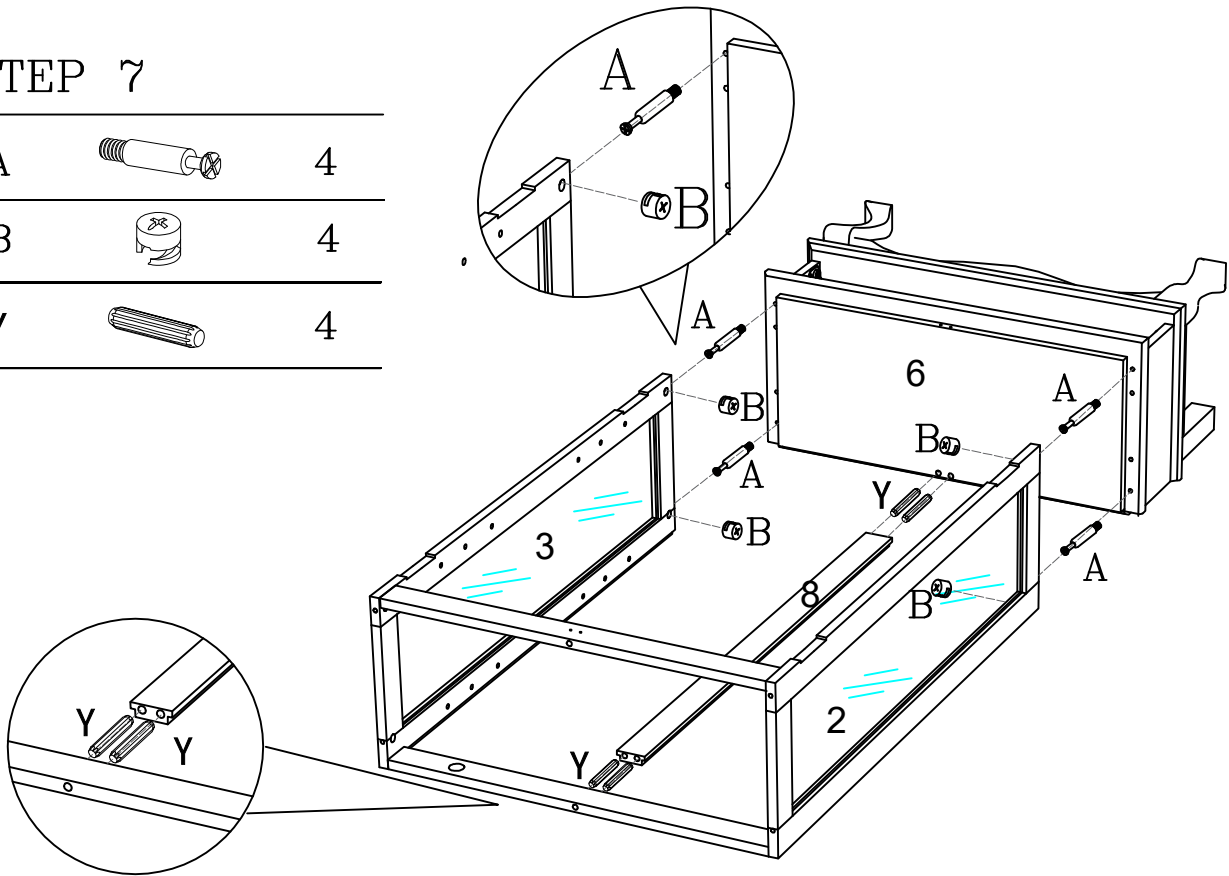
A		4
B		4
Y		4

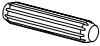

STEP 8

A		4
B		4
C		2

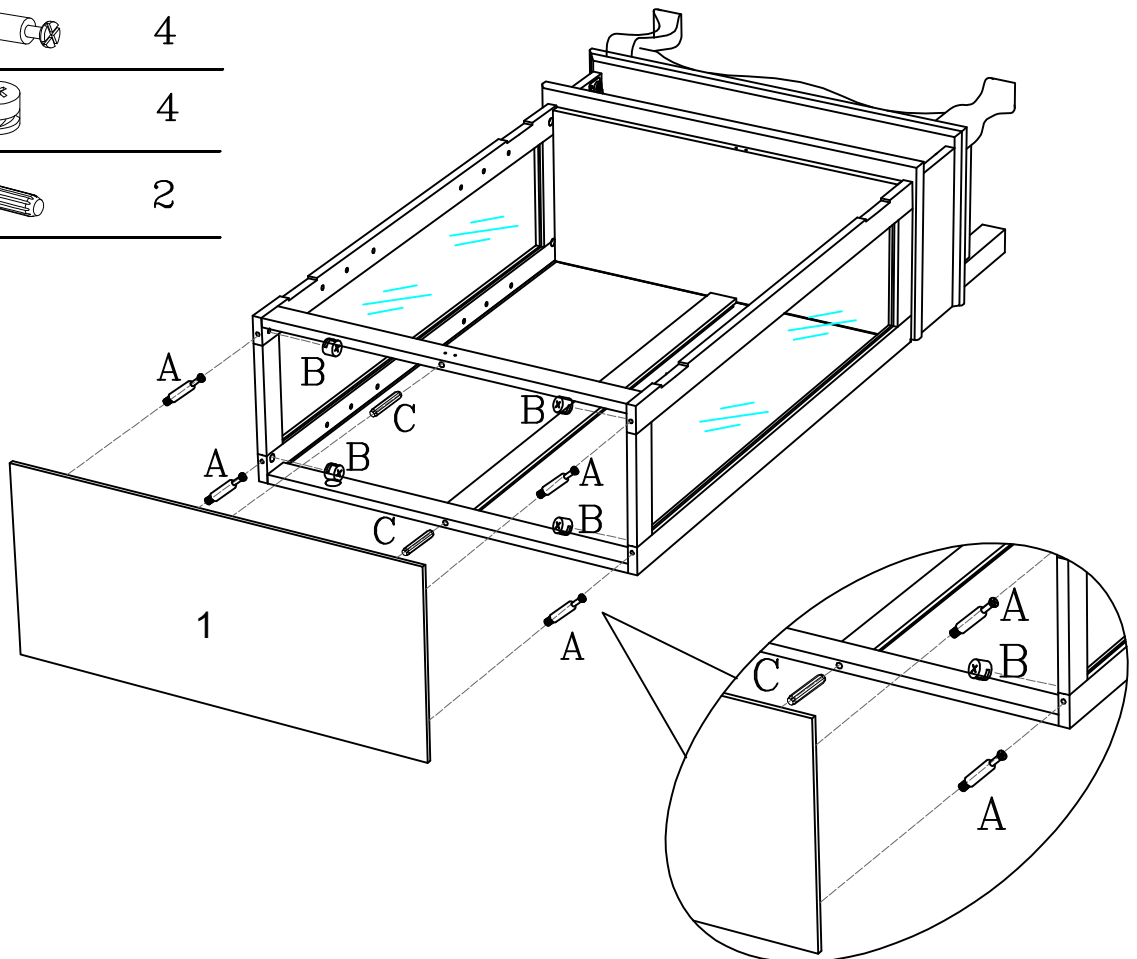





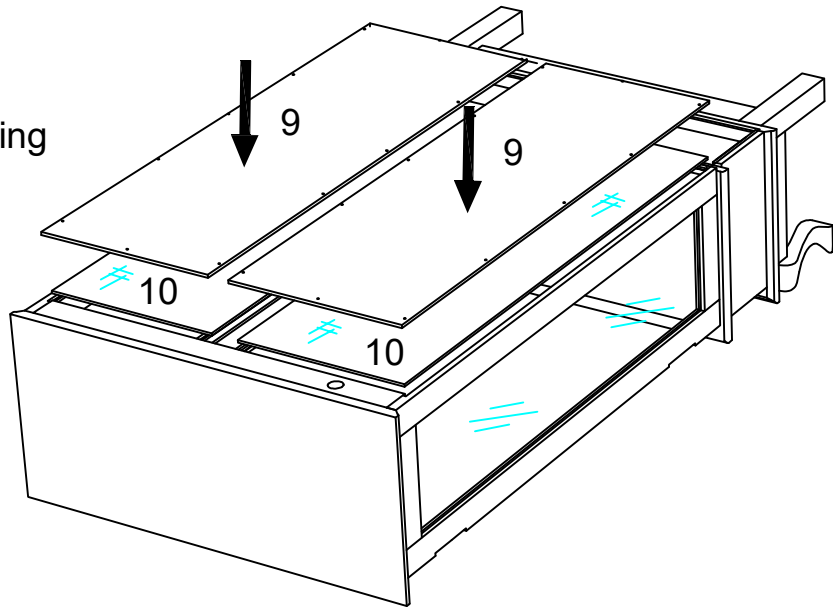
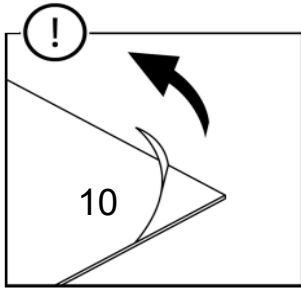

STEP 9

Please tear off the protective film of the mirror before assembling the mirror.





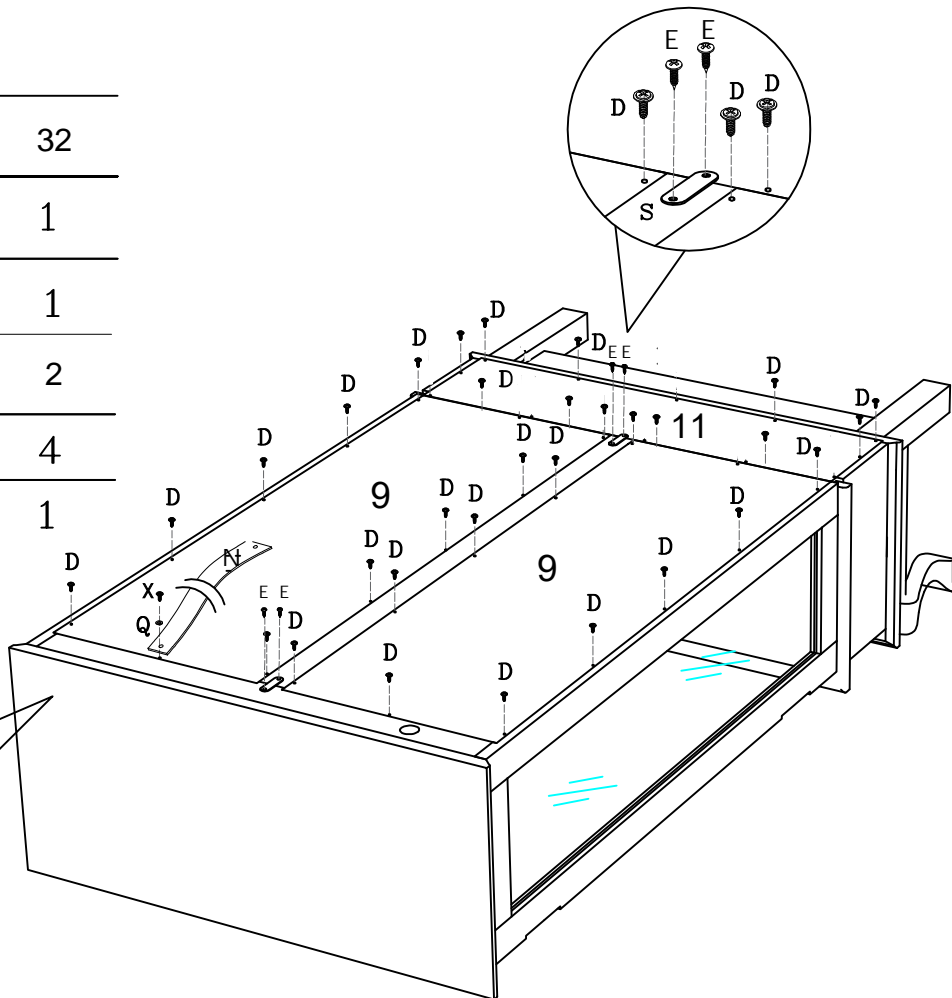
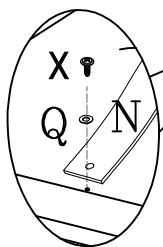

First, assemble Part # E & S, then assemble back screws Part # D.

STEP 10

D		32
N		1
Q		1
S		2
E		4
X		1

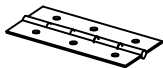

STEP 11

K		4
L		12
V		2
W		2
T		2

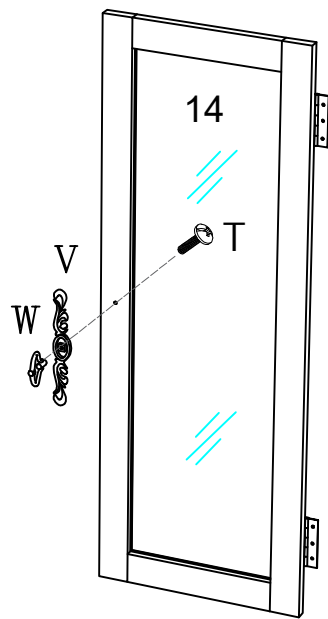
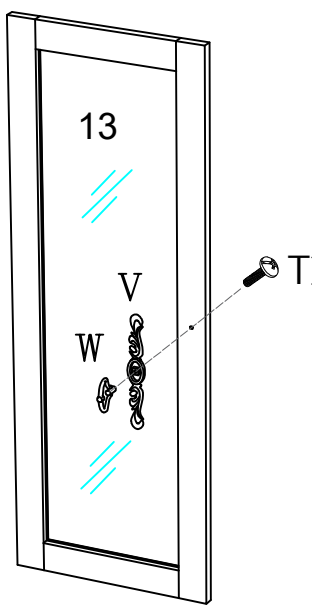
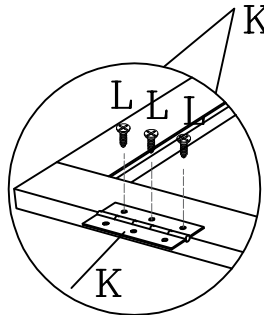
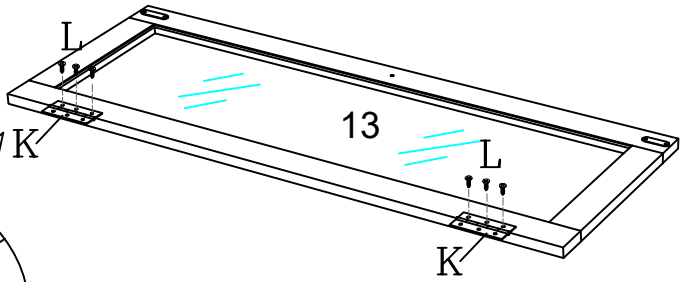
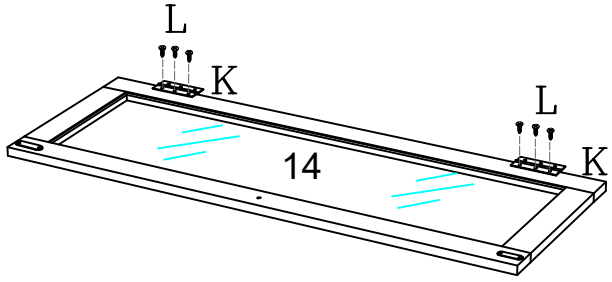

STEP 12

L



12

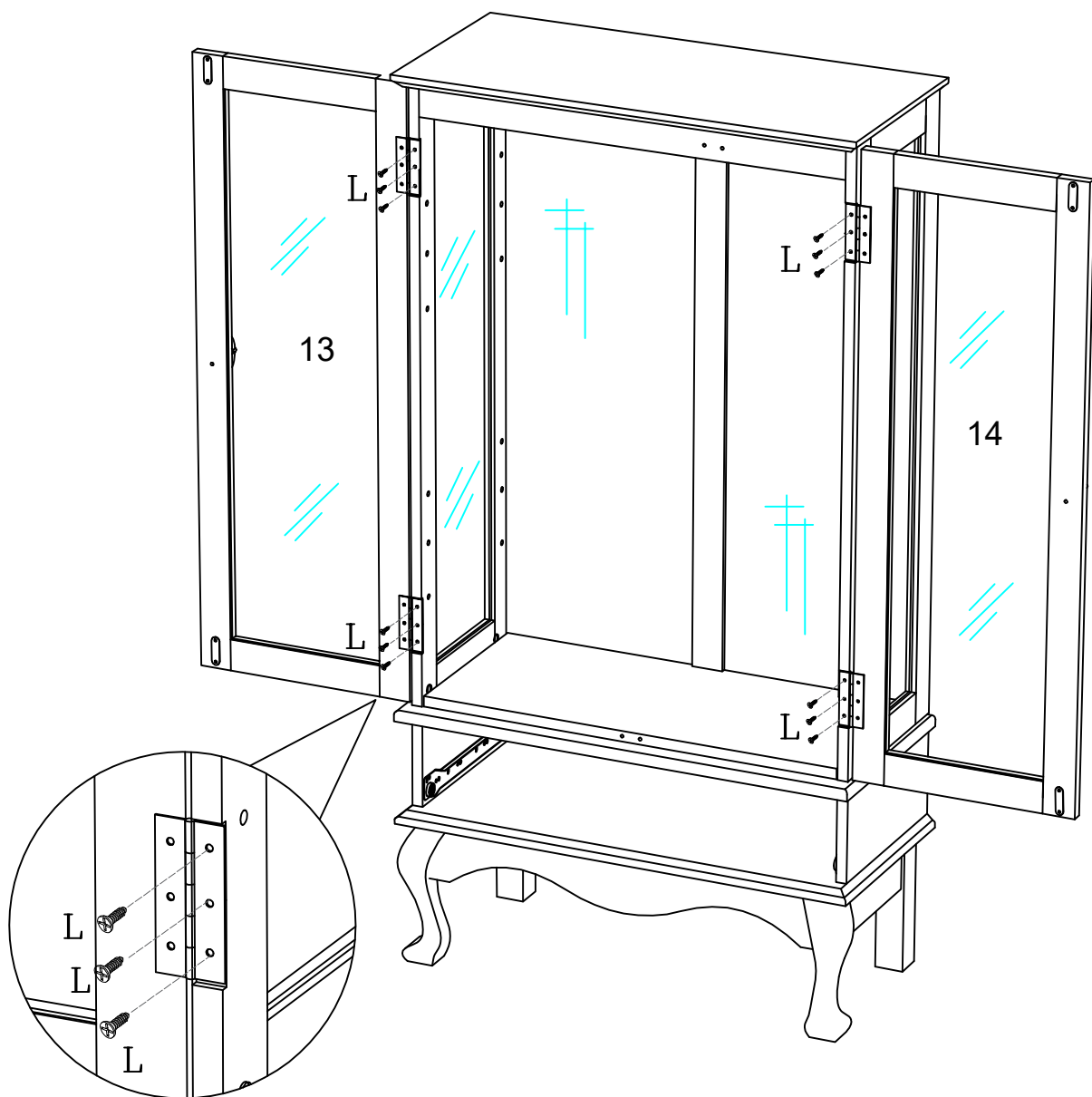



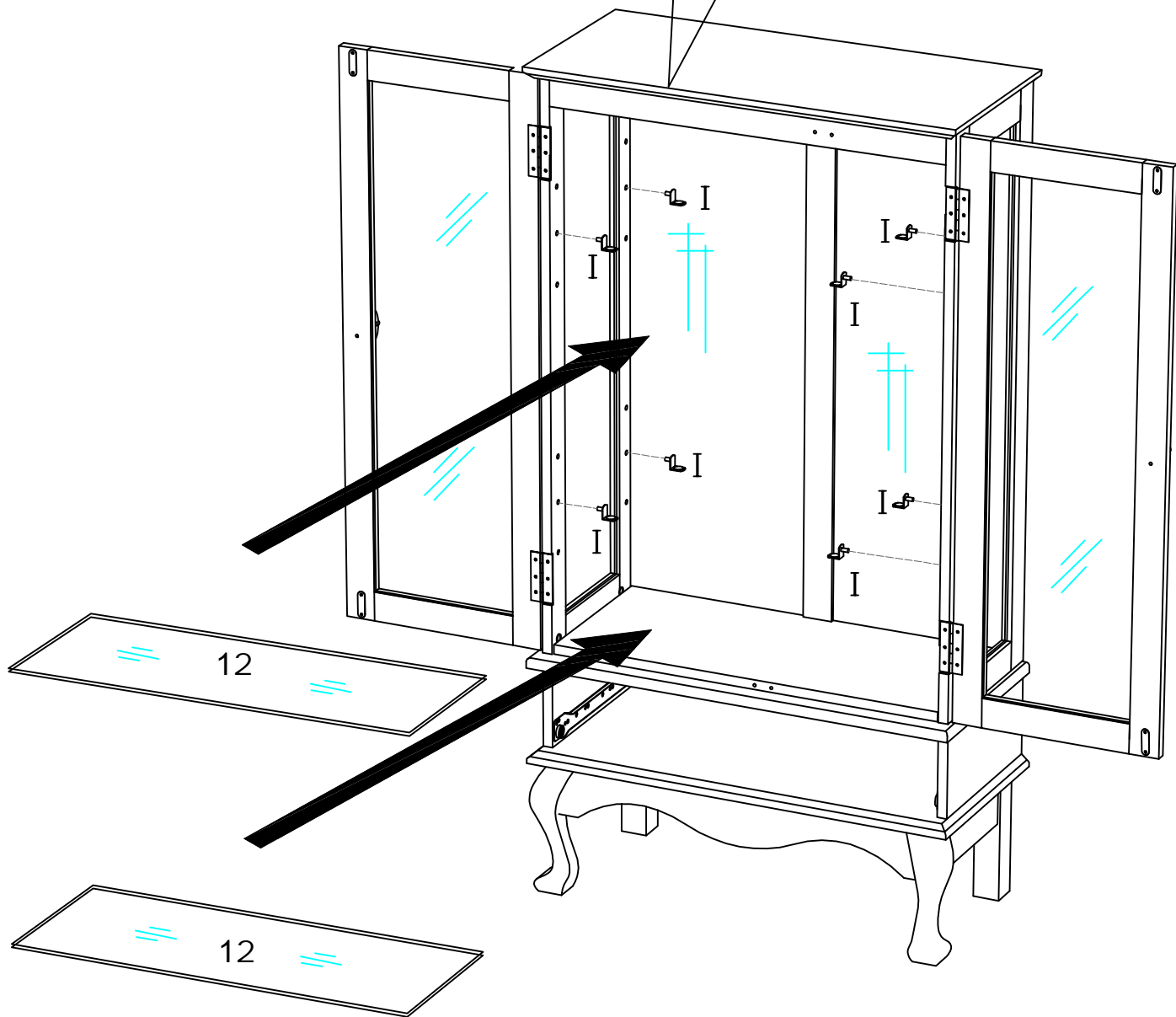
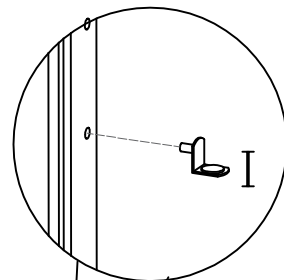

STEP 13

I  8



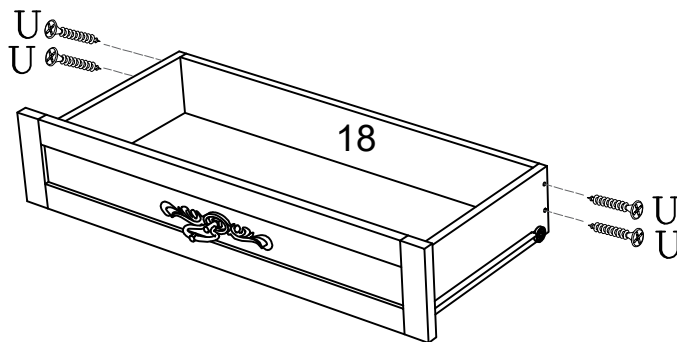
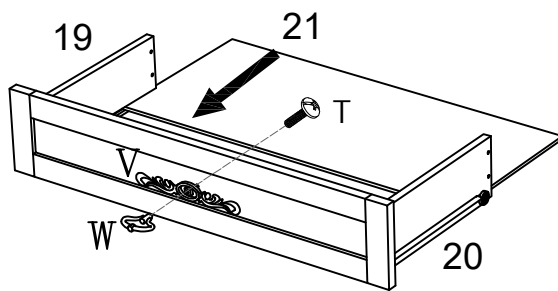
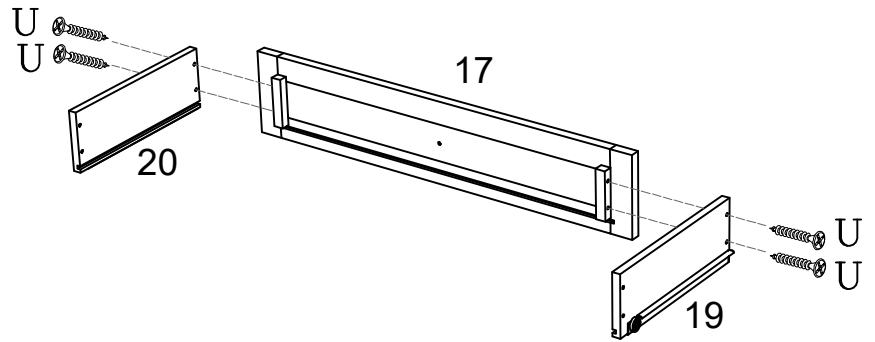

STEP 14

U		8
V		1
W		1
T		1



STEP 15

O		1
P		1
Q		1

