

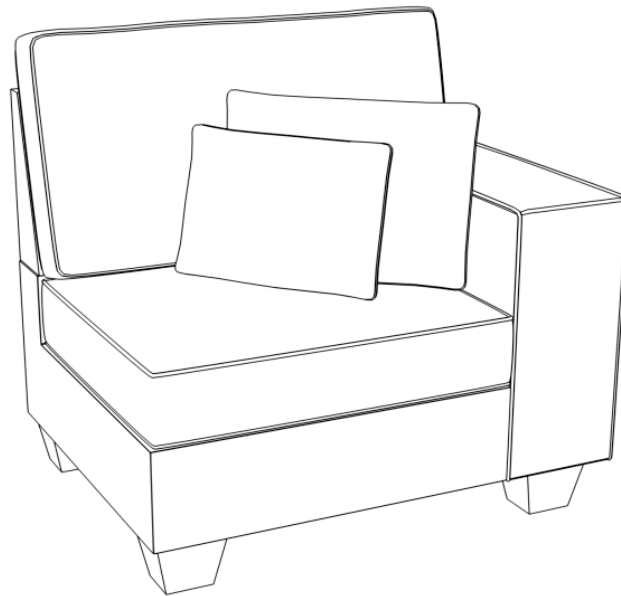

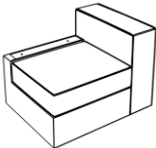







ASSEMBLY INSTRUCTION



PARTS LIST

				
A x1	B x1	C x1	D x1	E x1

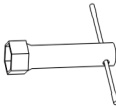
HARDWARE LIST

				
1 Bolt x2	2 Nut x2	3 Washer x2	4 Wrench x1	5 Leg x4

Step1

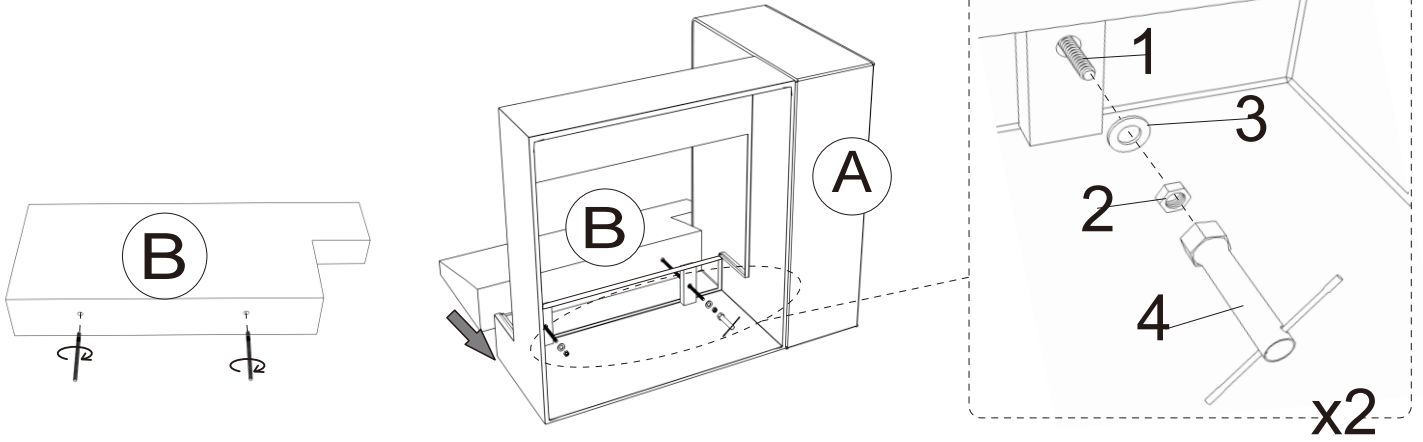

Step2

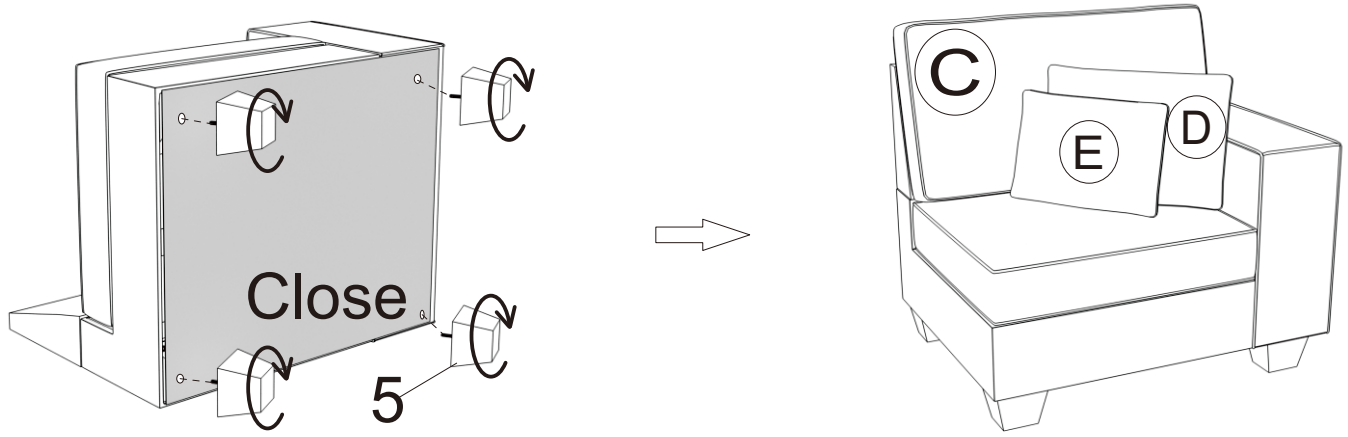

Launch the bottom connector.

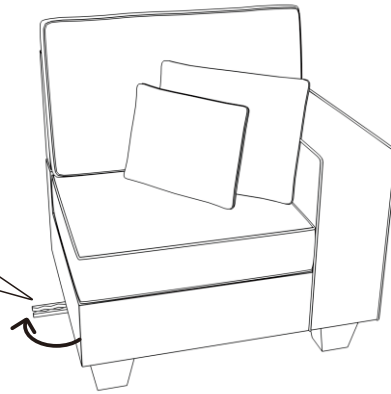

Can be combined with the same series of products.

