

3 Tier LED Umbrella User Manual

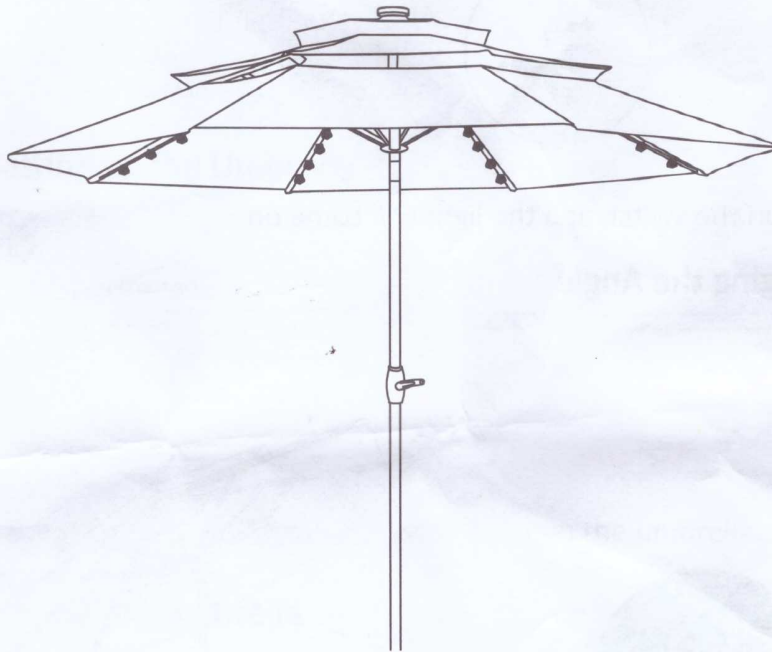

The size of the product customer receive will vary according to different models.

page

Safety Instructions

1. Use the umbrella in a wide open area.
2. When adjusting or opening the umbrella, make sure that no person is around for safety concerns.
3. Always close and put away the umbrella on windy days.
4. Keep the umbrella away from fire or other heating source.
5. Children are not supposed to operate the umbrella unless sufficient supervision is provided by adult.
6. Always open the umbrella by turning the crank.
7. We highly recommend that the setup of this umbrella should be carried by at least two people.
8. Turn off power button and disconnect the solar panel before using the solar panel for charging. To charge, place the solar panel under sun light for 8 hours. Ensure the sun light is sufficient or the battery in the solar panel is not fully charged.
9. When setting up, opening and closing the umbrella, please use caution to avoid risk of pinching hand.
10. Exercise caution when opening or closing the umbrella to avoid risk of scratching hand.

Package Contents

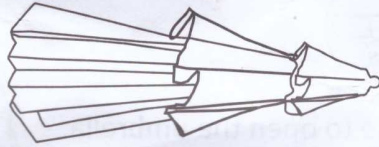

Umbrella Canopy x1

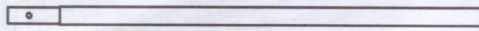

Extension Pole x 1

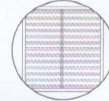

Top Cover x 1



strap X1

Find the plug at the top of the umbrella. Insert the plug into the socket under the Solar Panel.

1

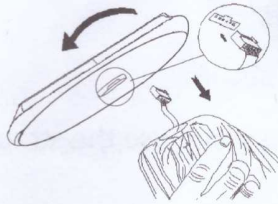

Fit the wire inside the top of the Umbrella, and turn the Solar Panel clockwise to attach it to the Umbrella. *Be careful not to over-tighten.*

Remove the clear plastic film on the Solar Panel.

2

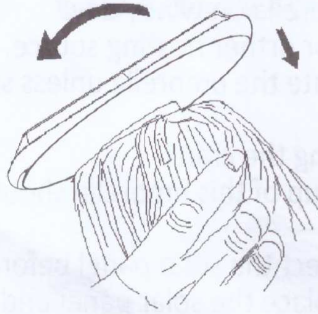

Setting up the Umbrella

3

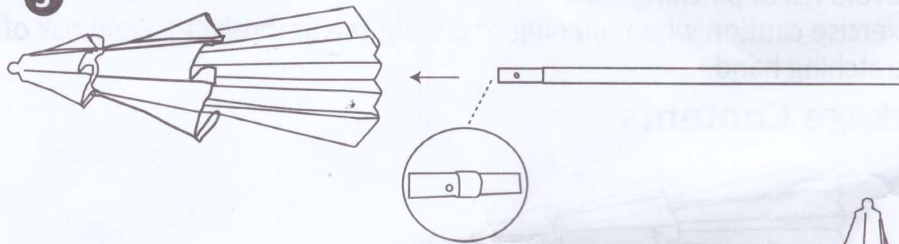

Rotate the crank handle clockwise to open the umbrella.

Closing the Umbrella



Use strap to secure

When the umbrella is not in use, close it and use the strap to secure the closing.

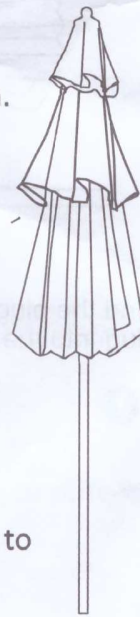

Connect the extension pole to the umbrella Canopy. Ensure that the node on the extension pole locks with the corresponding hole.

4

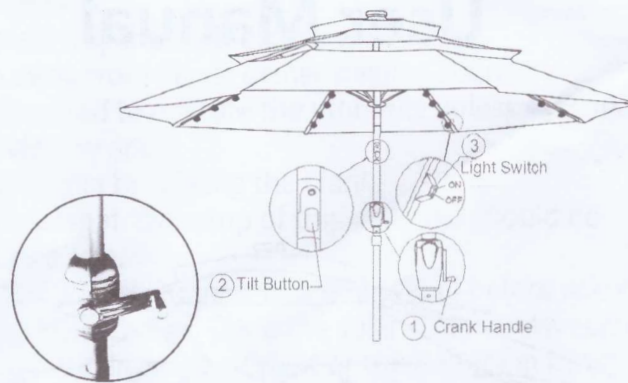



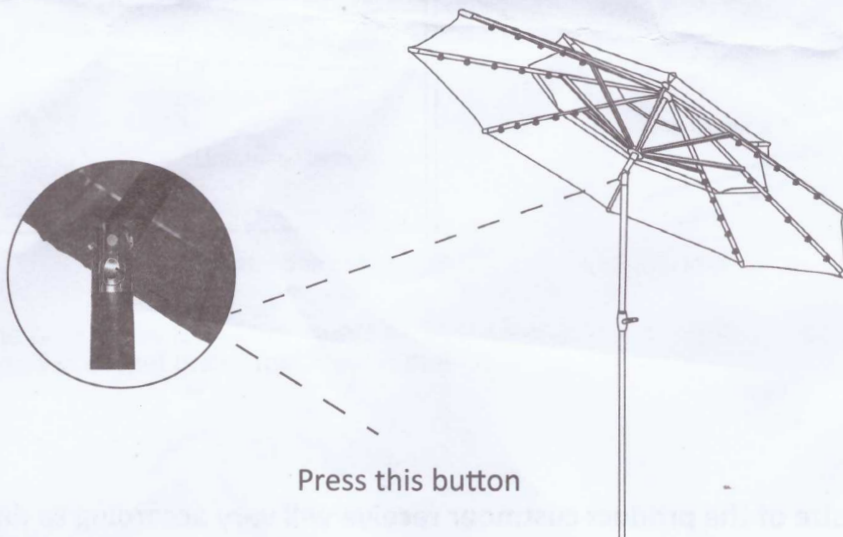

Turn on the switch and the light will come on

Changing the Angle

5

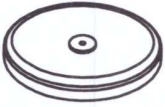
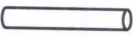
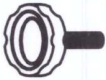

Press the button on the pole to change the angle.

A		1
B		1
C		1
D		1
E		1
F		1
G		1

