

Crystal Falls 2PK Sling Swivel Rocker Chair
Item #W22150
Assembly Instructions

****TO AVOID POTENTIAL SCRATCHING TO PARTS BY ROUGH GROUND SURFACE, COVER GROUND WITH SOFT SMOOTH PROTECTIVE MATERIAL ON WHICH TO PLACE PARTS DURING ASSEMBLY. ****

Step 1: Remove protective wrapping and lay all parts on floor. Identify all parts packed in carton against the parts list.

Step 2: Lay Seat Bucket (A) on its front side. Align each pair of holes on the two Fiber Springs to the two pair of holes on the Brace of the Seat Bucket(A). Then place C-Brackets(I) over Brace and Fiber Springs so all holes are aligned correctly as shown in Diagram 1.

Step 3: Attach this assembly together with Bolts (C), Washer(D), Spring Washer(E), Nut(F). Put all bolts, washers, and nuts in their proper positions first before tightening securely with Hex Wrench(J).

Step 4: Make sure all bolts are aligned properly and tightened securely. Then place Bolt Covers (G) and Nut Covers(H) over Nuts and Bolts.

NOTE: IT IS USER'S RESPONSIBILITY TO MAKE SURE ALL PARTS ARE ASSEMBLED AND TIGHTENED PROPERLY AND SECURELY.

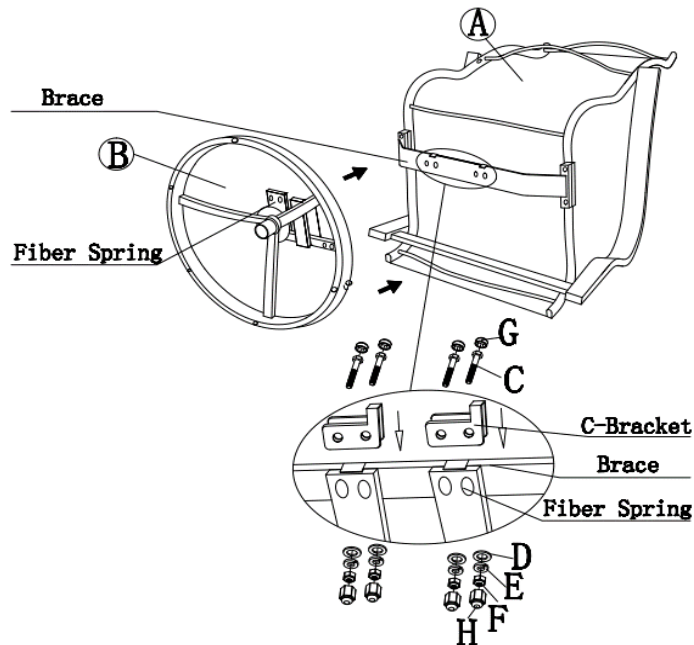
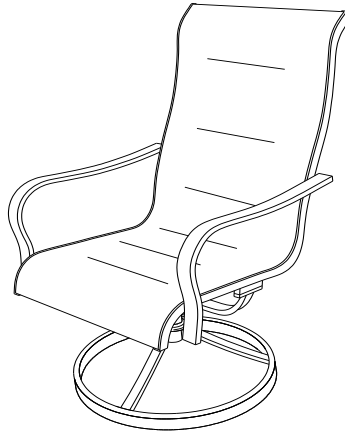

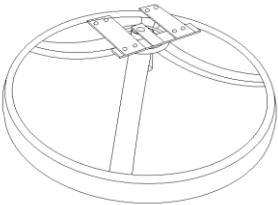
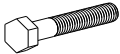





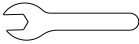

Diagram 1

Diagram 2



Parts List
(Total Qty for 2 Chairs)

Ref	Part Name	Part Image	Qty	Ref	Part Name	Part Image	Qty
A	Seat Bucket		2	B	Base		2
C	Bolt(M8)		8	G	Bolt Cover		8
D	Washer		8	H	Nut Cover		8
E	Spring Washer		8	I	C-Bracket		4
F	Nut		8	J	Hex Wrench		2

WOODARD
Customer Service Hours
 8:00am-5:00pm CST Monday to Friday
 Phone: (800) 877-2290 Fax: (800) 733-4257
 E-mail: retail3@woodard-furniture.com