

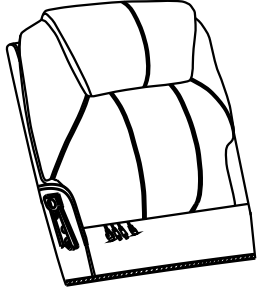

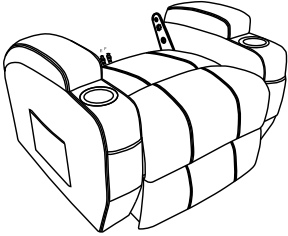
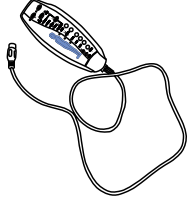

Massage Recliner Assembly Instruction

						
Backrest	Chair base	Remote control	Power cord	Power source	Power source	Remote control

STEP 1

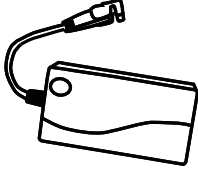

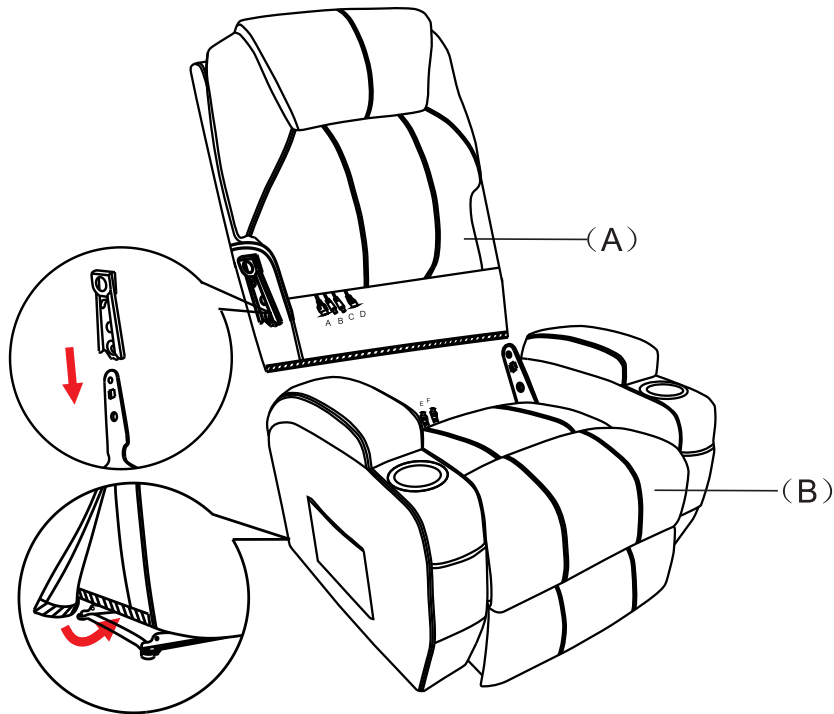
STEP 2

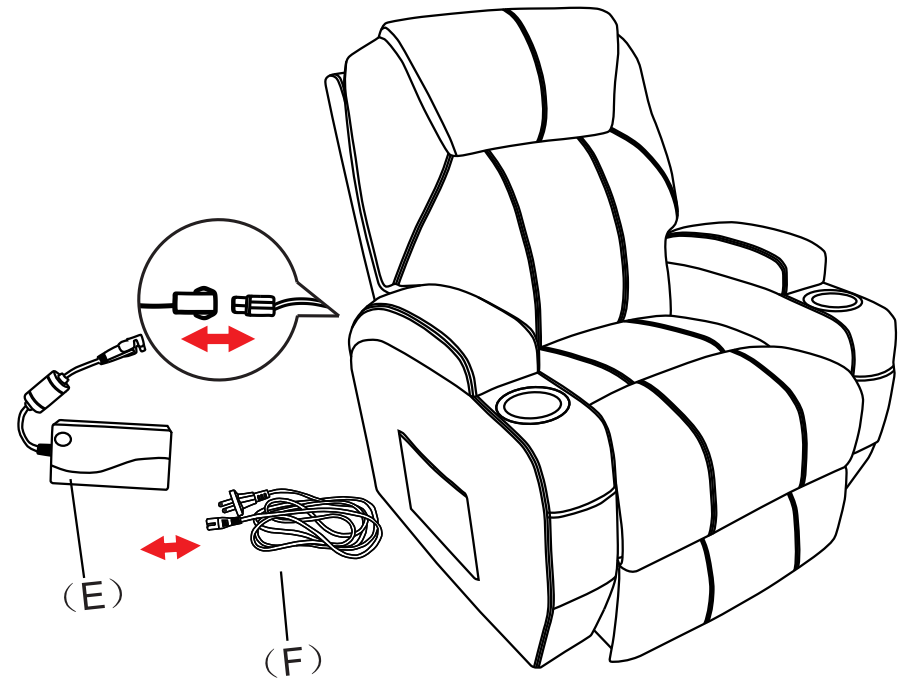

Massage Recliner Assembly Instruction

STEP 3

No.1 and No.2 wire connect with the backrest and chair base.
No.3 wire connects with backrest and power cord(D).
No.4 wire connects with backrest and remote control(C).

NOTE: Two same color wires connect.

