

Accent Chair

ASSEMBLY INSTRUCTION

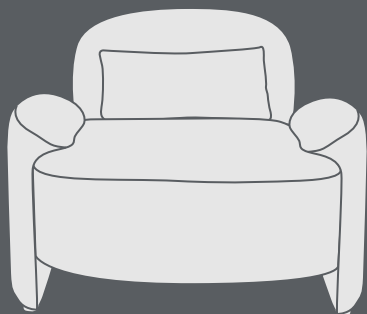

Dear customer, Thank you very much for buying our items. Please read the assembly instruction carefully before assembly.

Notices:

- Verify that all parts are present and in good condition before assembly.
- Put the chair on a clean flat surface.
- Please tighten the screws to about 80% for the first step; Then, sit with caution on the chair to adjust the balance; Finally, tighten all the screws to 100%.
- If you find that is unlevel after assembly, you can use adjustable pegs to keep four legs level.

Contact us

If there are installation problems, damage, missing parts, or any questions and concerns, please contact the shop where you bought it so we can make things right.

If the product is damaged, please send the following information:

- Photos that show the reason for your claim/damage.
- Photos of the packaging (inside and outside).

Thank you very much for your support!

Package Contents

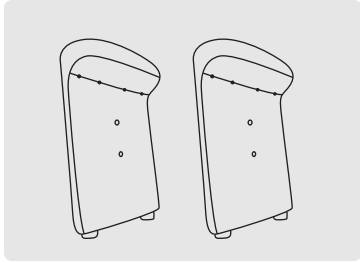

Armrests

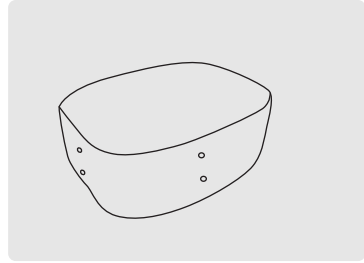

Seat

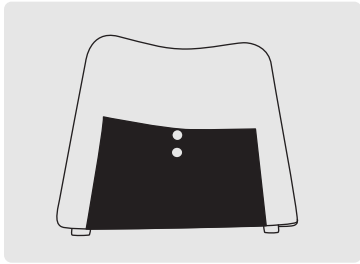

Backrest

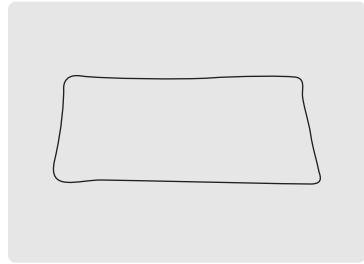

Pillow

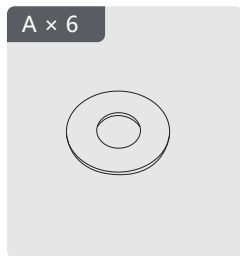

Flat Washer

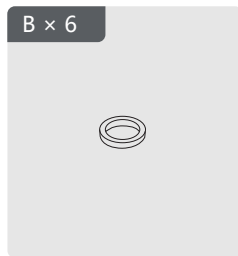

Lock Washer

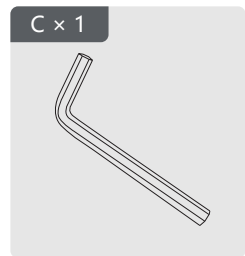

Allen key

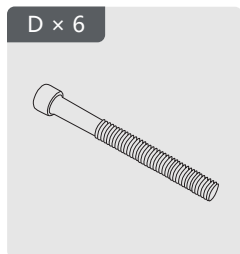

M8x70mm
Screws

Step by Step Guide

1

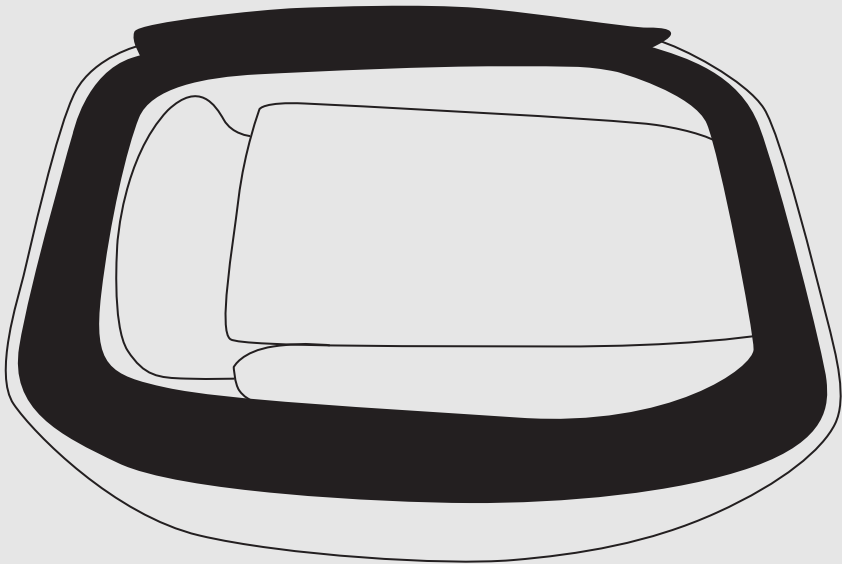

Open the non-woven fabric of the seat and take the armrests and pillow out from under the seat.

Step by Step Guide

2

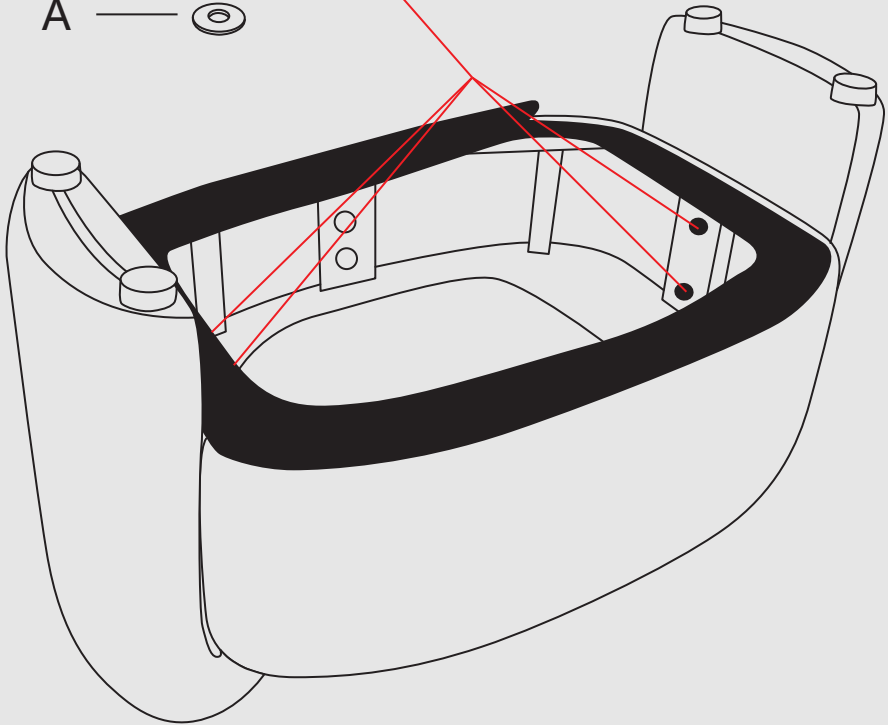
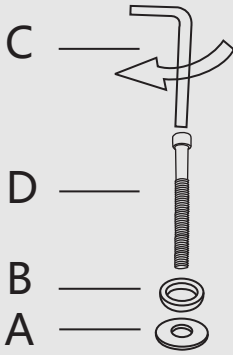

Align the armrest holes with the screw holes on both sides of the seat by using screws (D) and washers (#A, B)

After alignment, tighten them up to 80%

Step by Step Guide

3

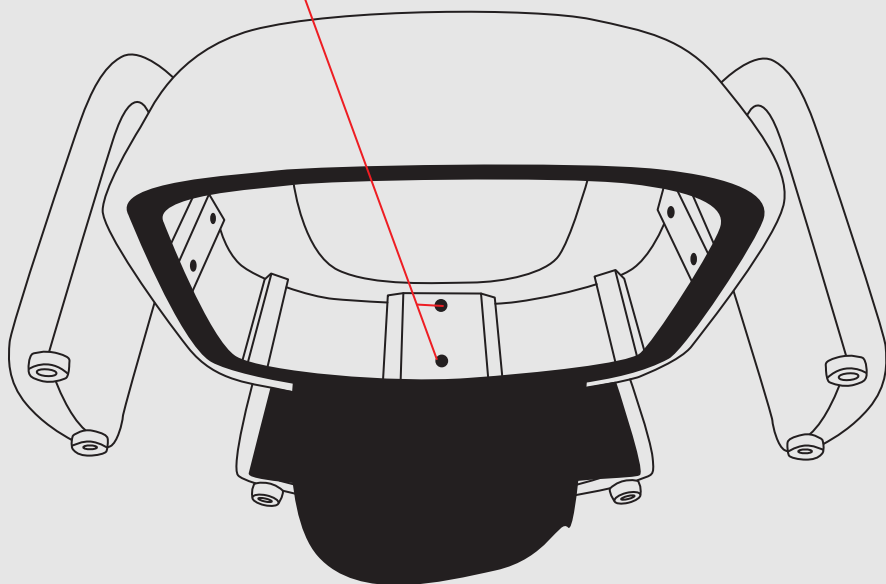
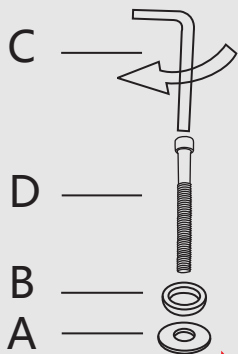

Align the backrest holes with the screw holes of the seat by using screws (D) and washers (#A, B)

After align tighten them up to 80%

Step by Step Guide

4

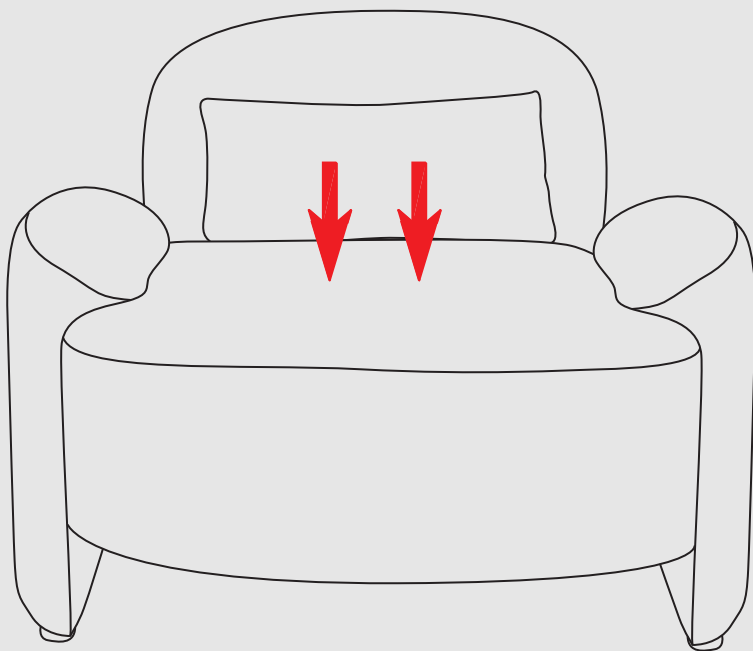
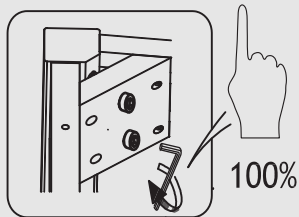

Sit on the chair or please put a heavy object, and check whether the chair is steady or not, then tighten all screws up to 100%

If the chair are not steady, please check all of the screws are tightened, and put pillow on chair.