

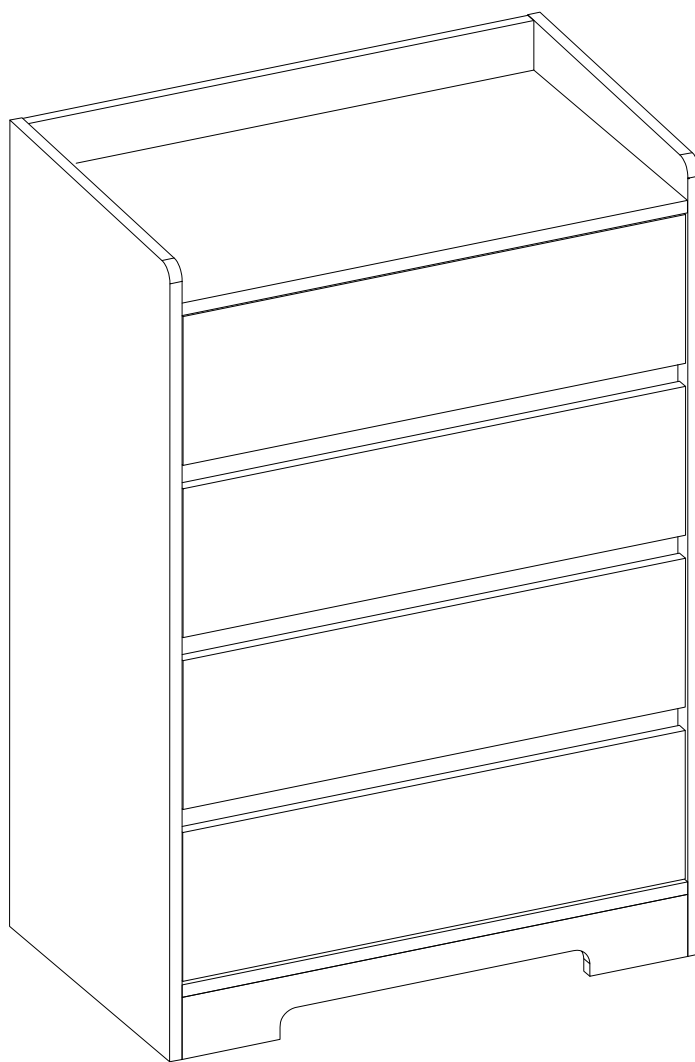

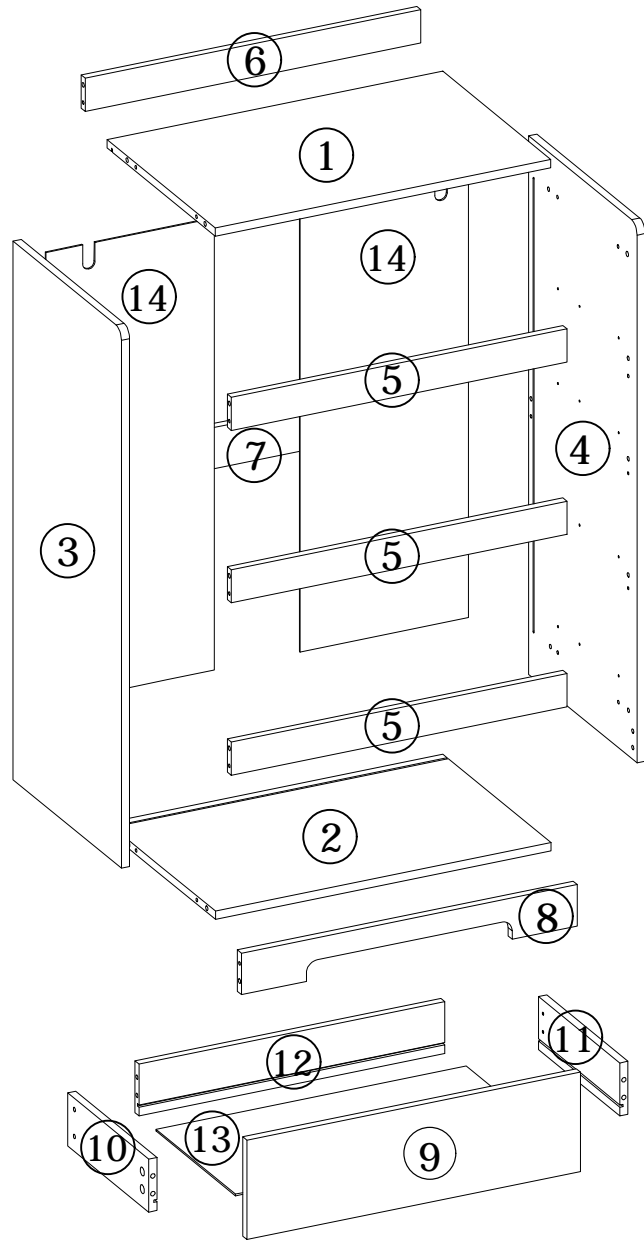

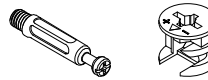

User's Manual

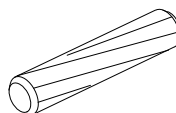
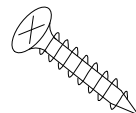
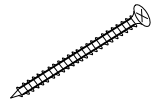
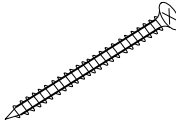

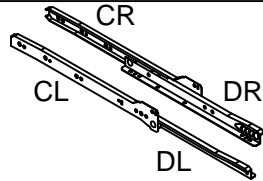

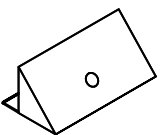
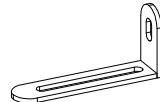
X4

<p>A</p>  <p>A1 A2 36PCS</p>	<p>B</p>  <p>$\phi 8 \times 30 \text{mm}$ 20PCS</p>	<p>C</p>  <p>M3.5*14mm 58PCS</p>	<p>D</p>  <p>M3.5*35mm 16PCS</p>
<p>E</p>  <p>M3.5*40mm 2PCS</p>	<p>F</p>  <p>M8*40mm 2PCS</p>	<p>G</p>  <p>L=300mm 4PCS</p>	<p>H</p>  <p>6PCS</p>
<p>I</p>  <p>8PCS</p>	<p>J</p>  <p>65X32X15mm 2PCS</p>	<p>K</p>  <p>L=809mm 1PC</p>	<p>L</p>  <p>$\phi 21 \text{mm}$ 36PCS</p>

1

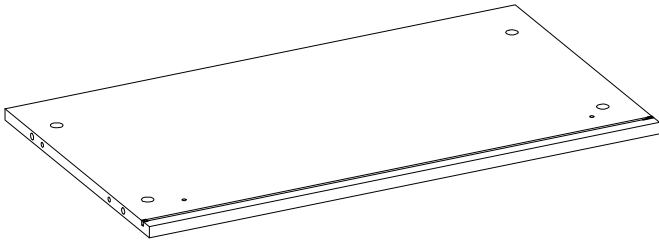

620*399*15mm

1 PC

2

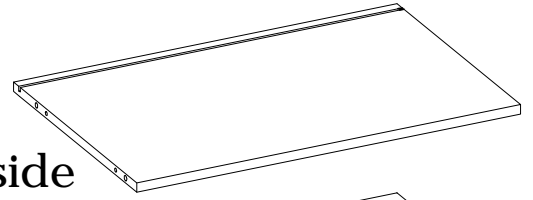

one side

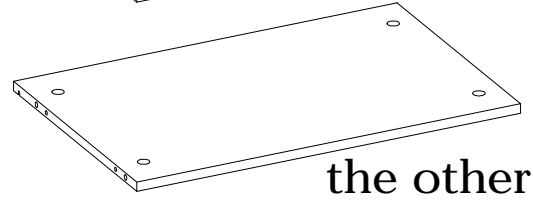

the other side

620*399*15mm

1 PC

3

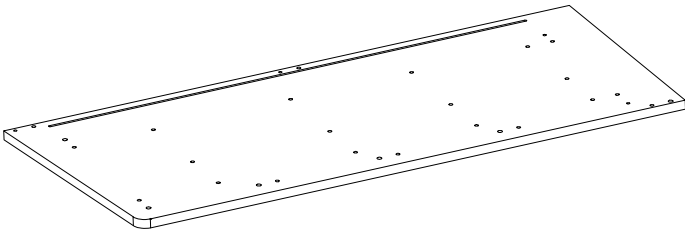

975*400*15mm

1 PC

4

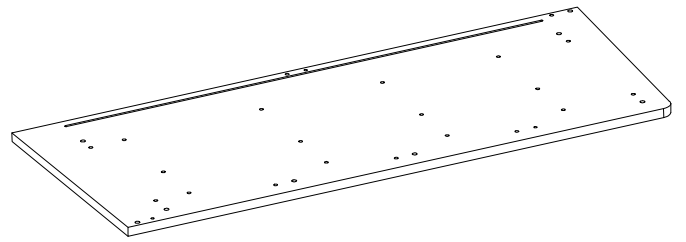

975*400*15mm

1 PC

5

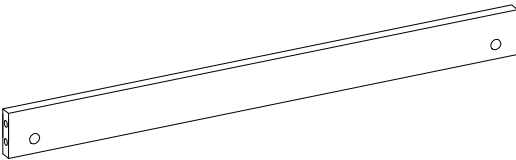

620*60*15mm

3 PCS

6

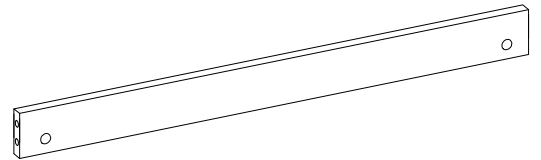

620*60*15mm

1 PC

7

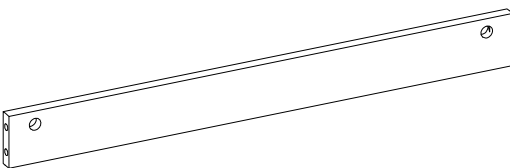

620*75*15mm

1 PC

8

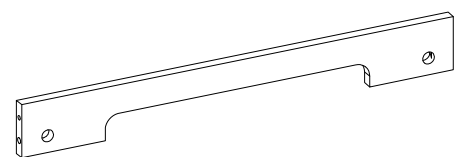

620*75*15mm

1 PC

9

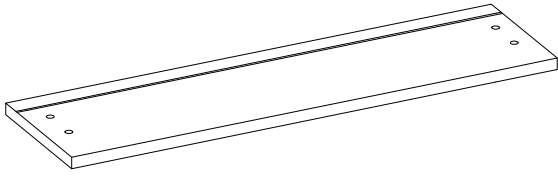

180*616*15mm

4 PCS

10

the other side

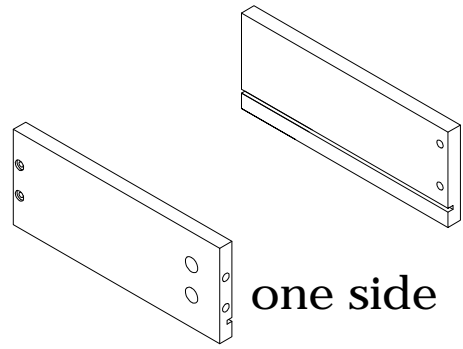

one side

300*96*15mm

4 PCS

11

the other side

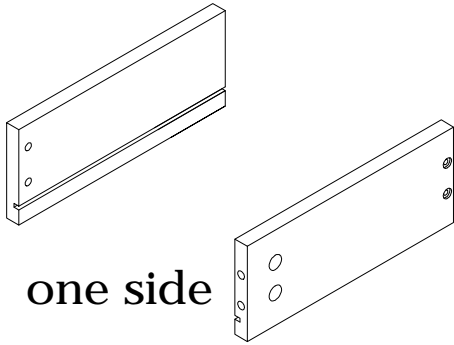

one side

300*96*15mm

4 PCS

12

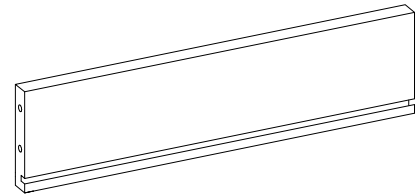

565*96*15mm

4 PCS

13

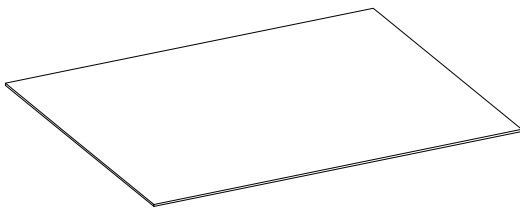

575*295*3mm

4 PCS

14



819*315*3mm

2 PCS

Hardware installation demonstration



NOTE: Please make sure "A1" hardware tightened and can't be pulled out!

I

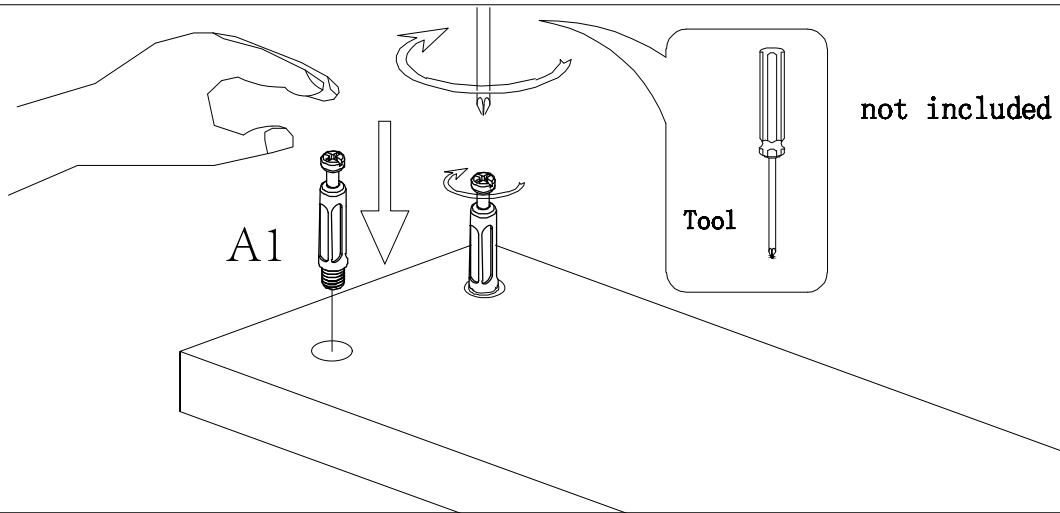

II

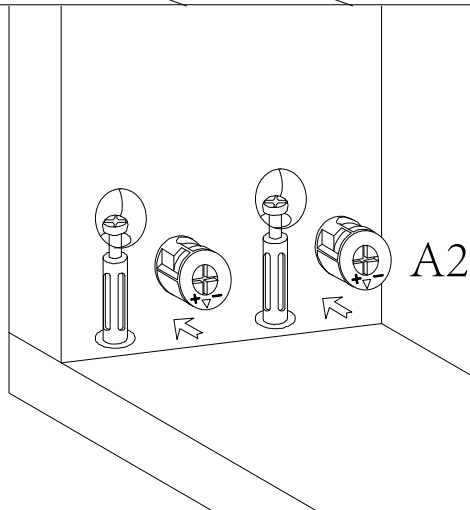

III

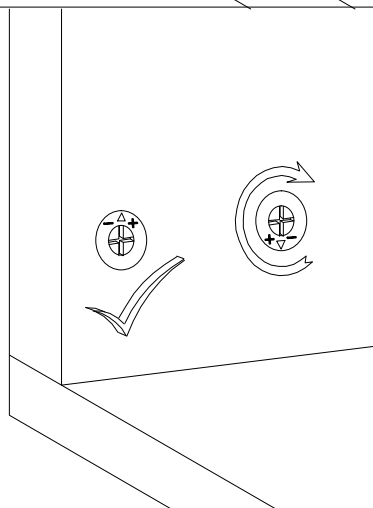

STEP 1

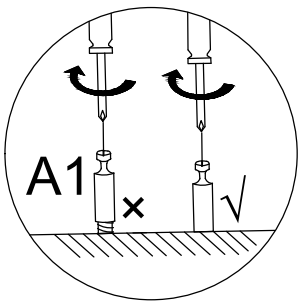
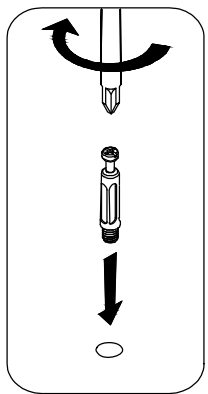

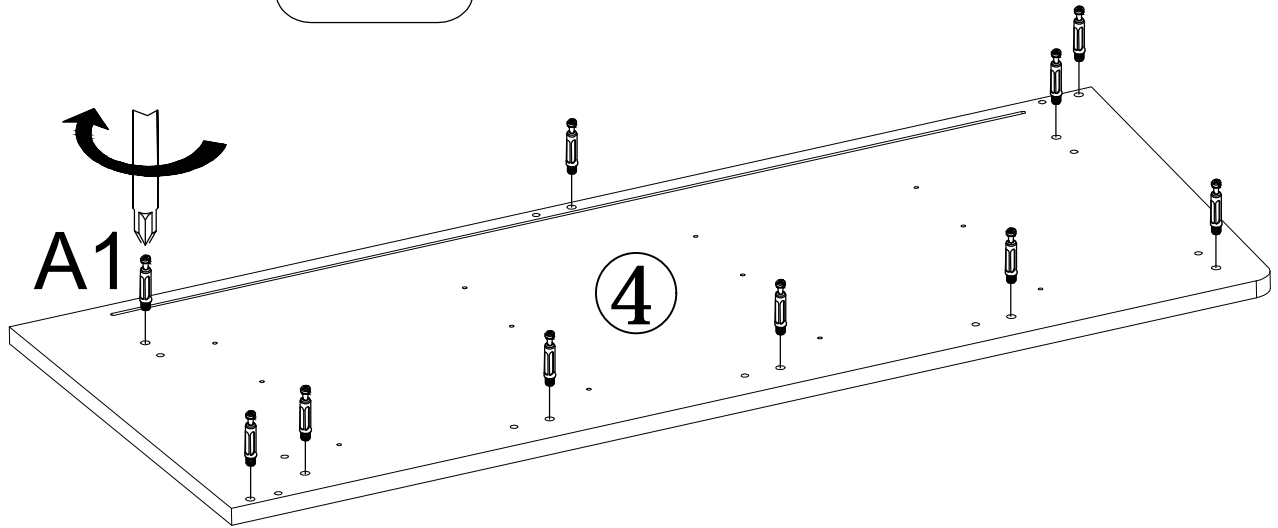

Tighten it , Same after

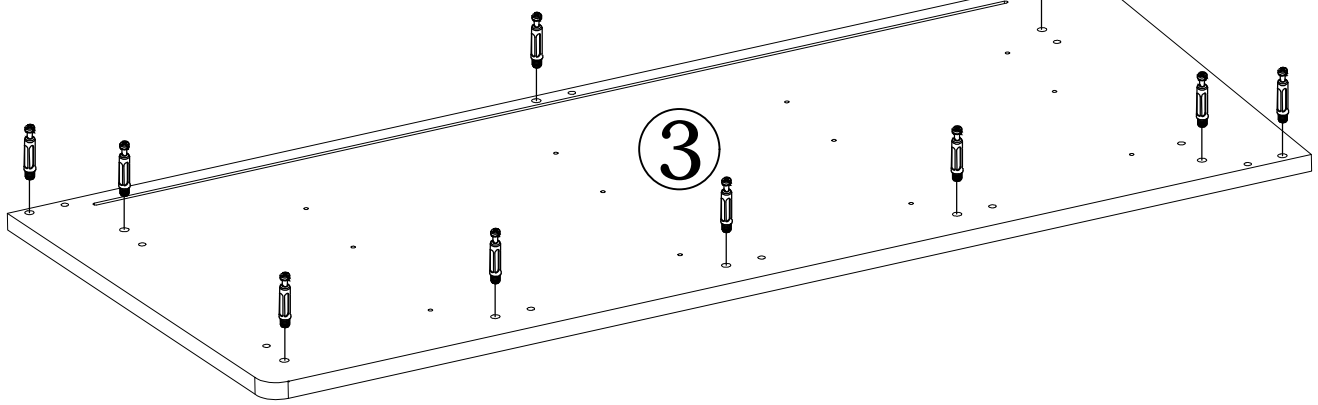
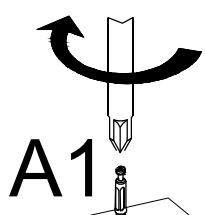
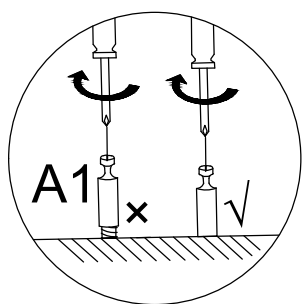

	A1 × 10PCS
--	------------

STEP 2



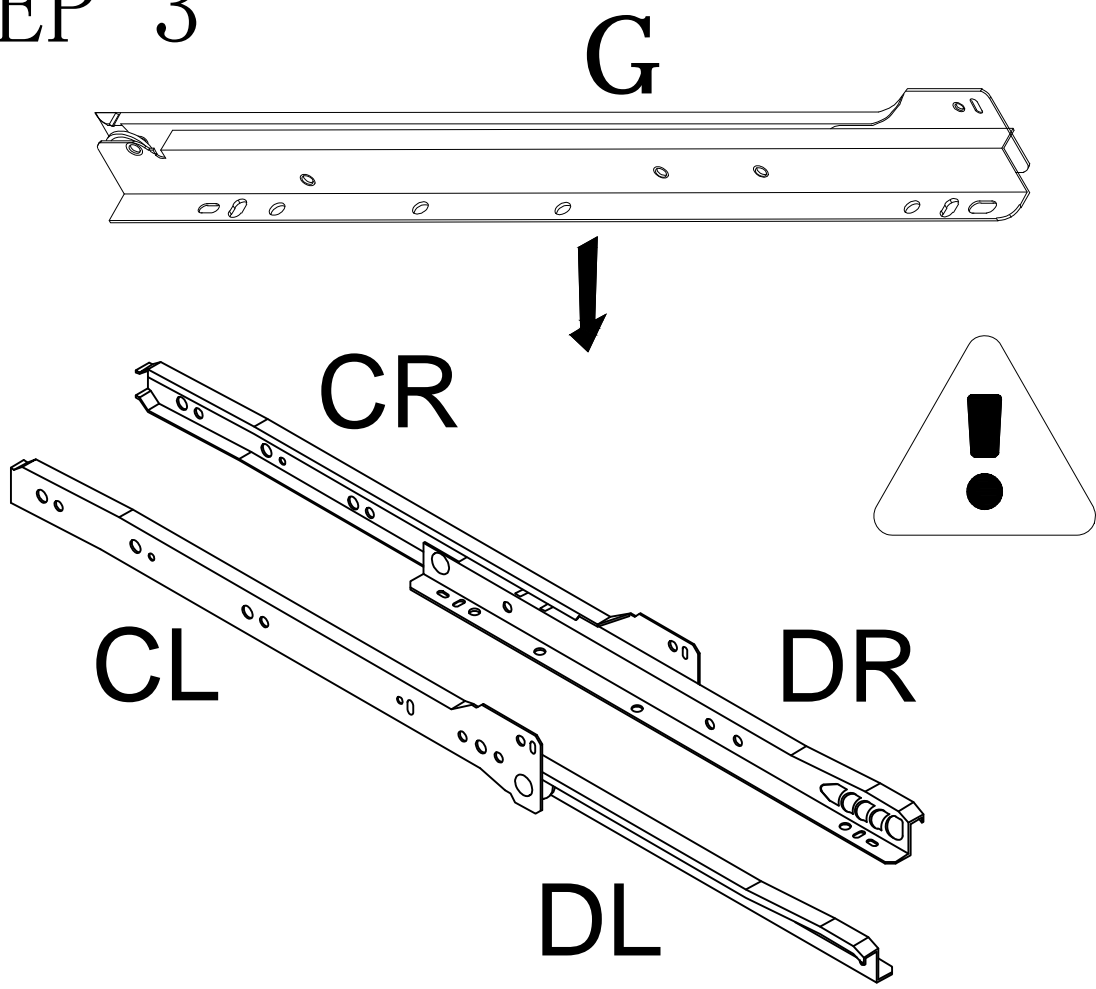

	A1 × 10PCS
---	------------

STEP 3



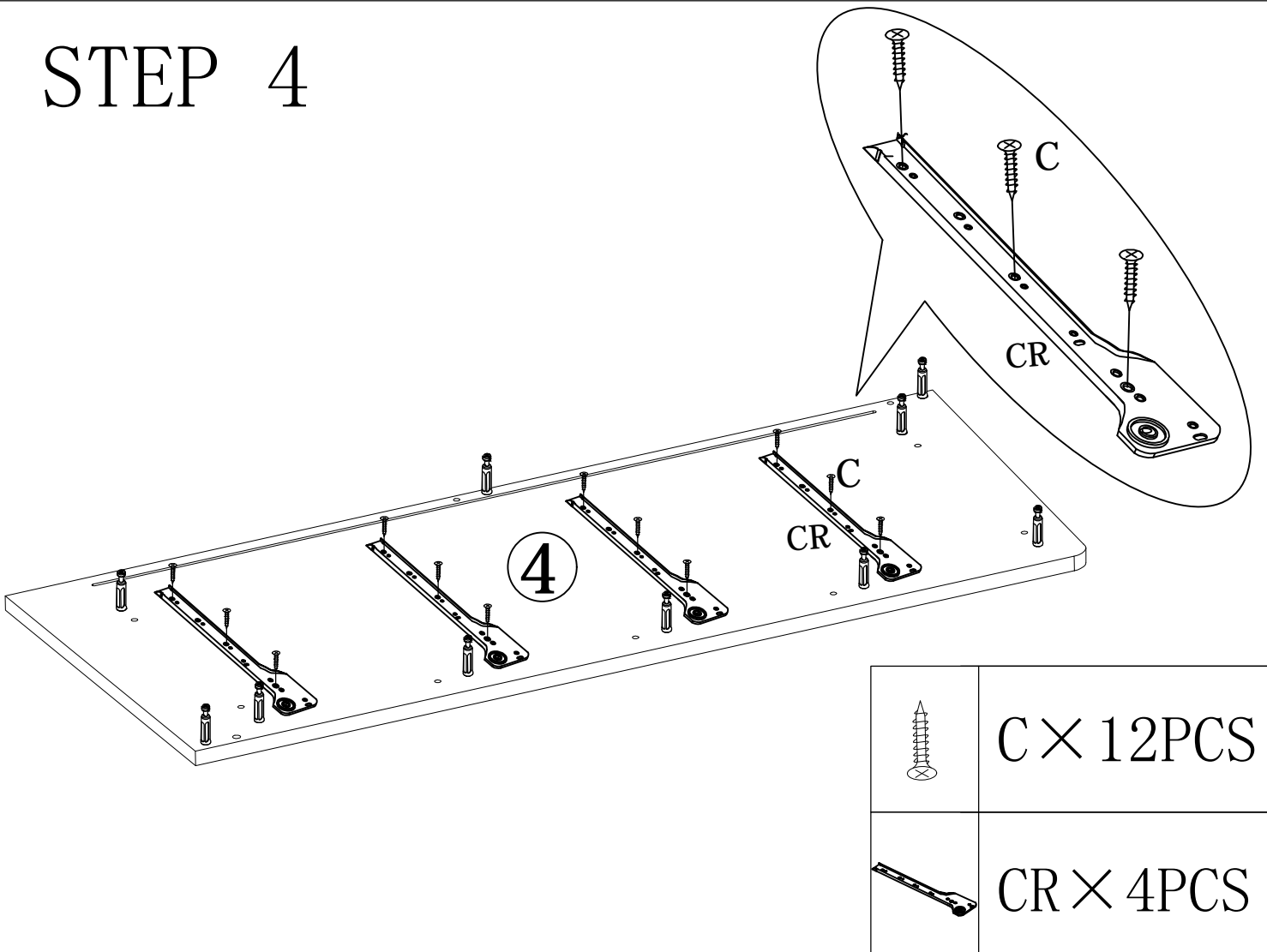

STEP 4



	C × 12PCS
	CR × 4PCS

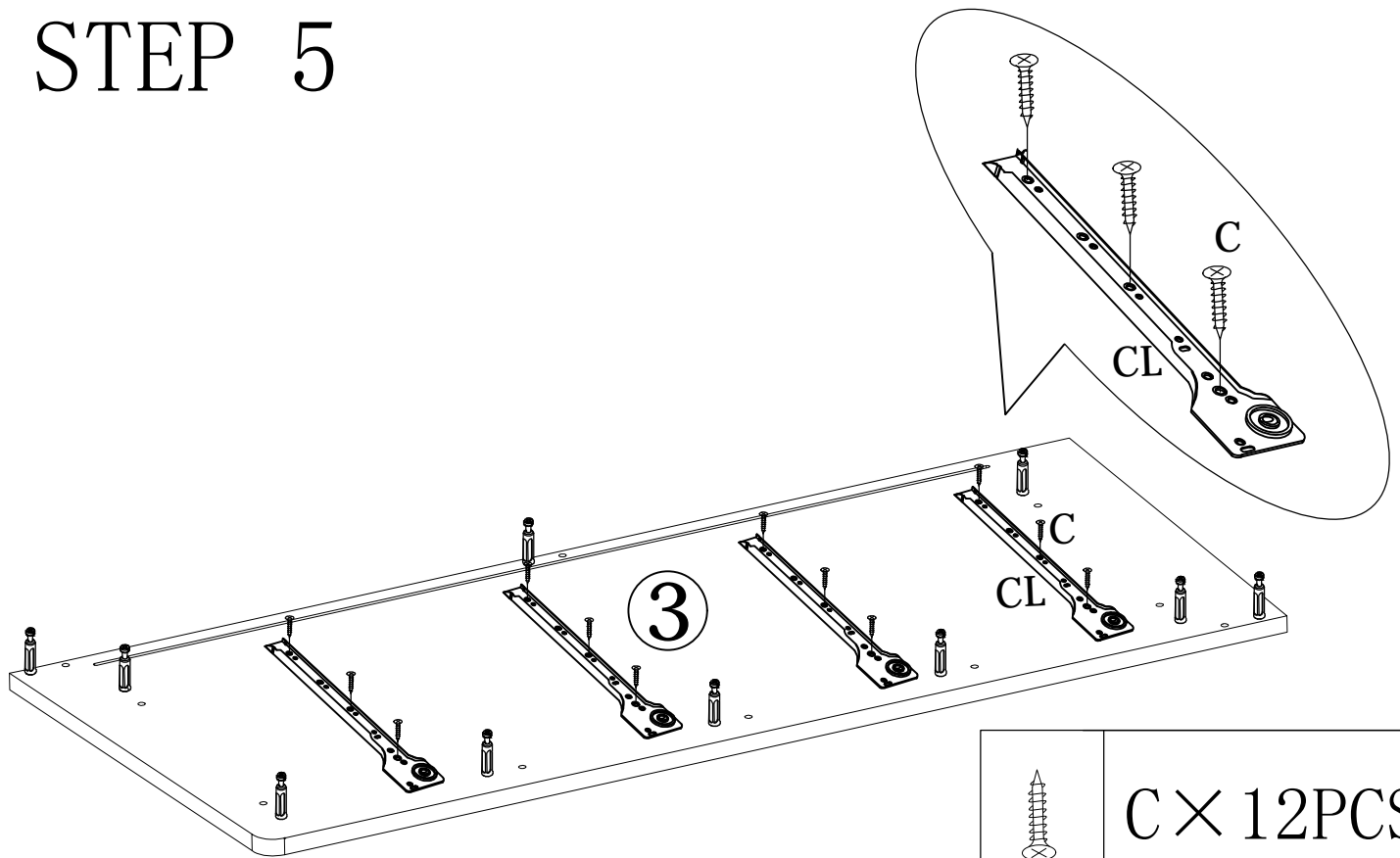

STEP 5

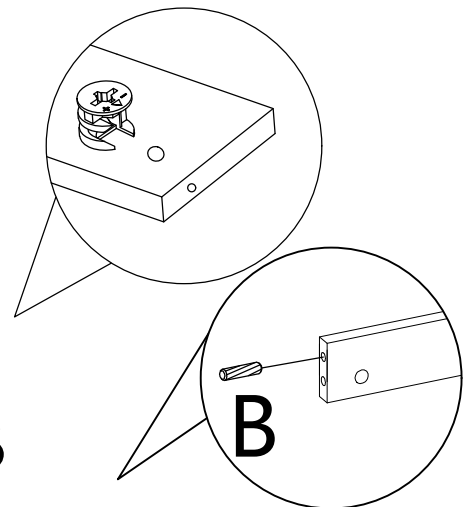
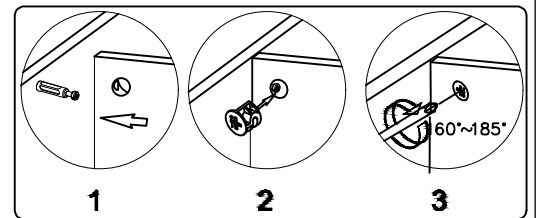
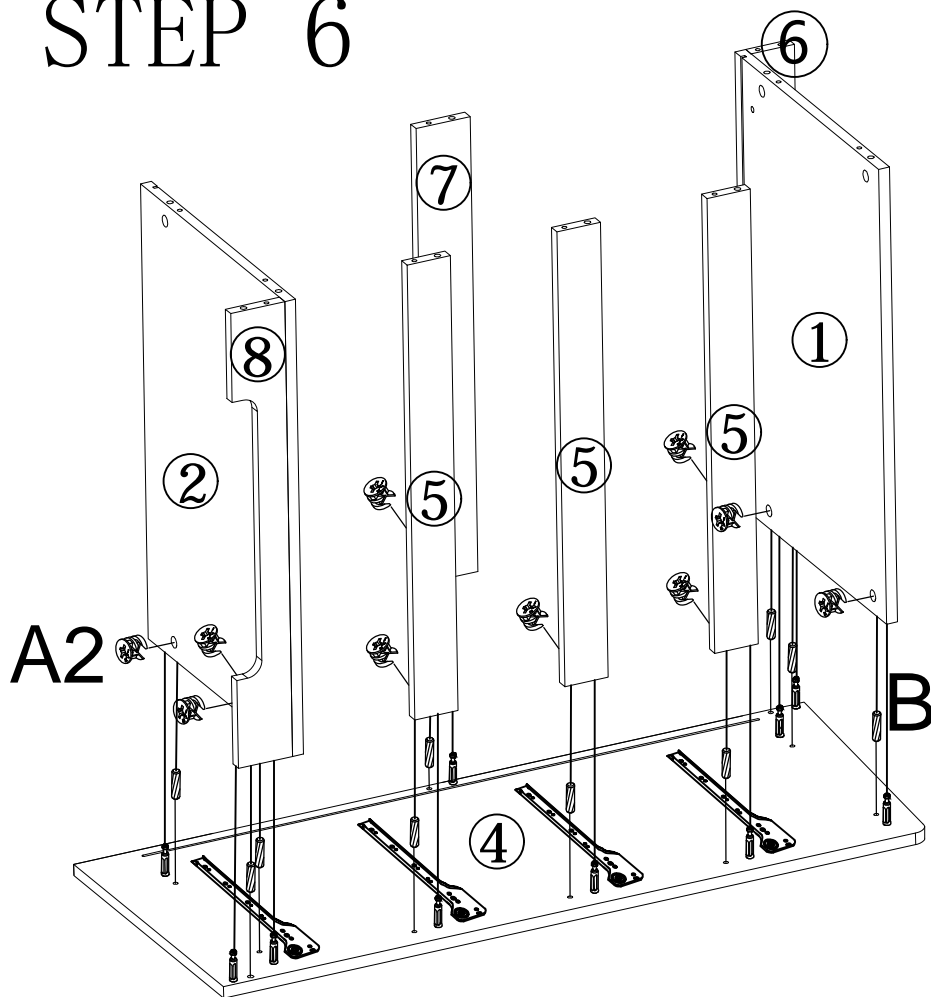

	C × 12PCS
	CL × 4PCS

STEP 6



	A2 × 10PCS
	B × 10PCS

STEP 7

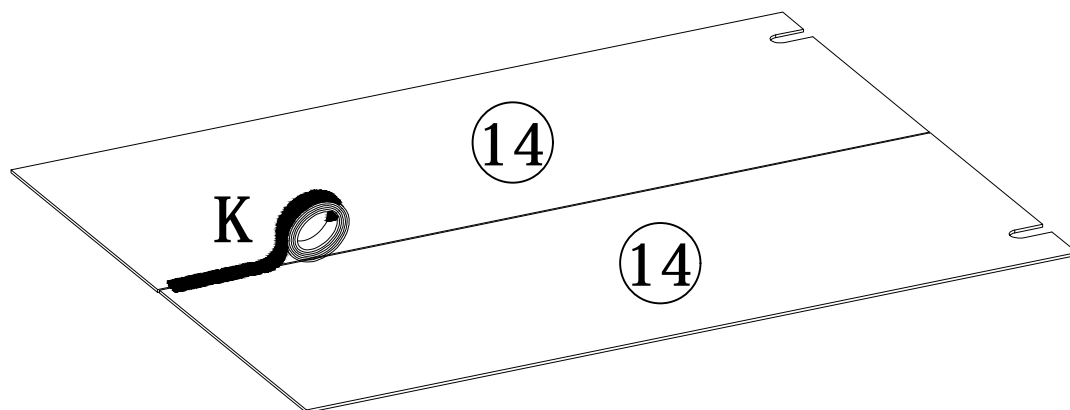

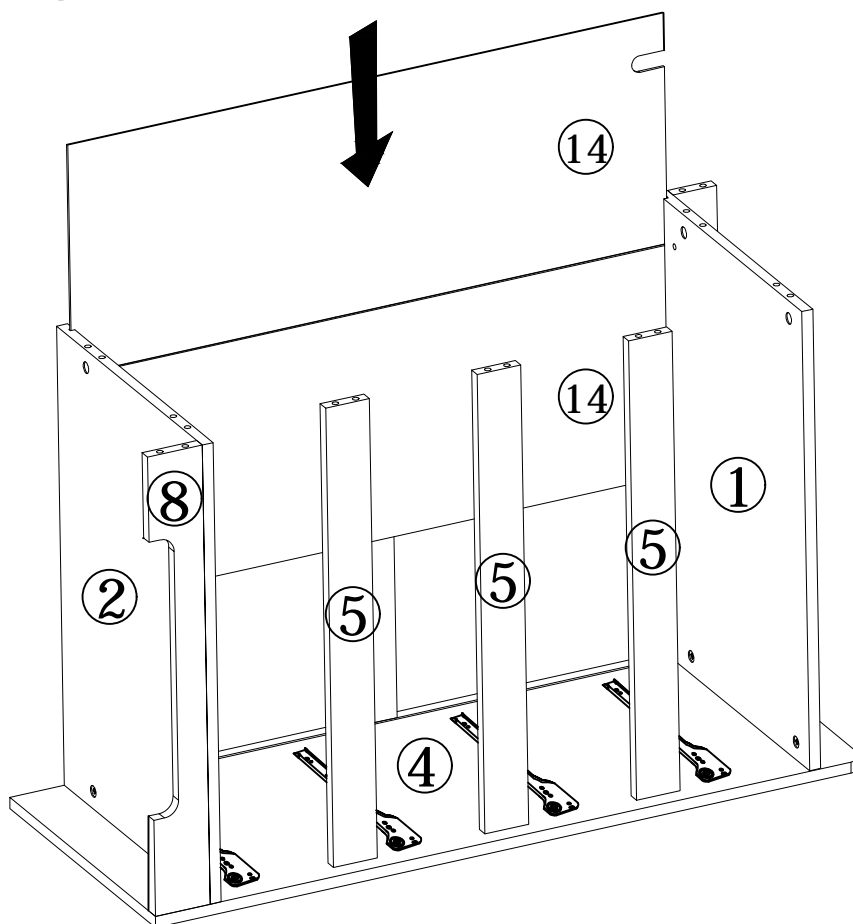

K × 1PC

STEP 8



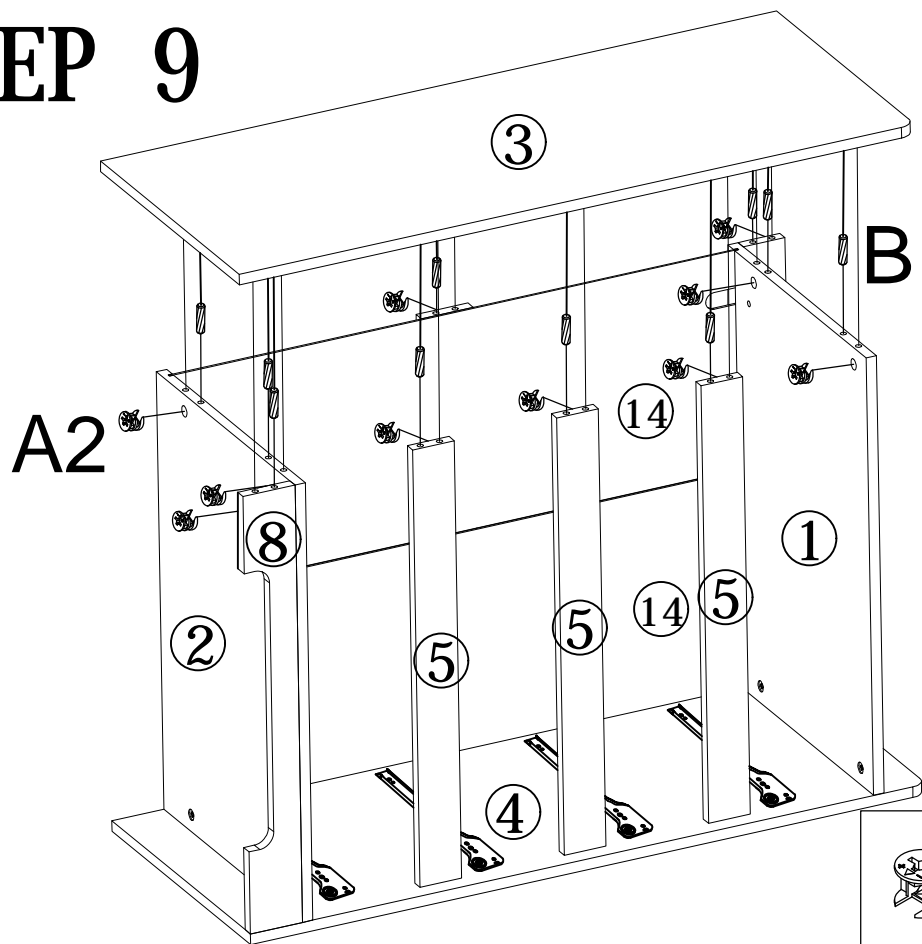

STEP 9

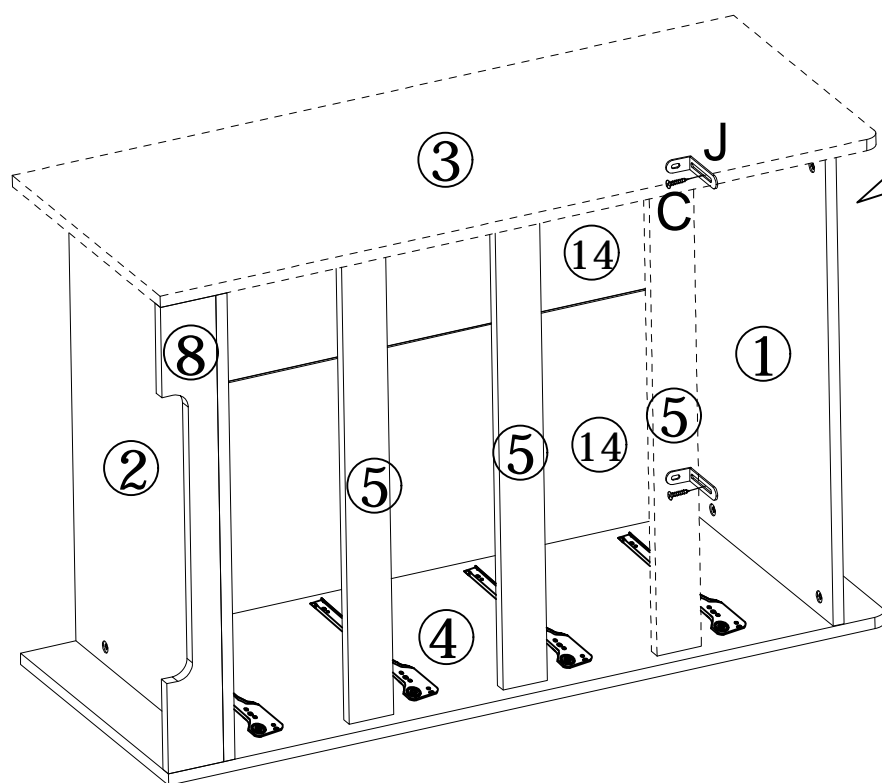

	A2 × 10PCS
	B × 10PCS

STEP 10



	C × 2PCS
	J × 2PCS

STEP 11

X4

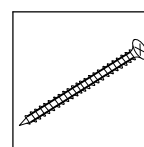
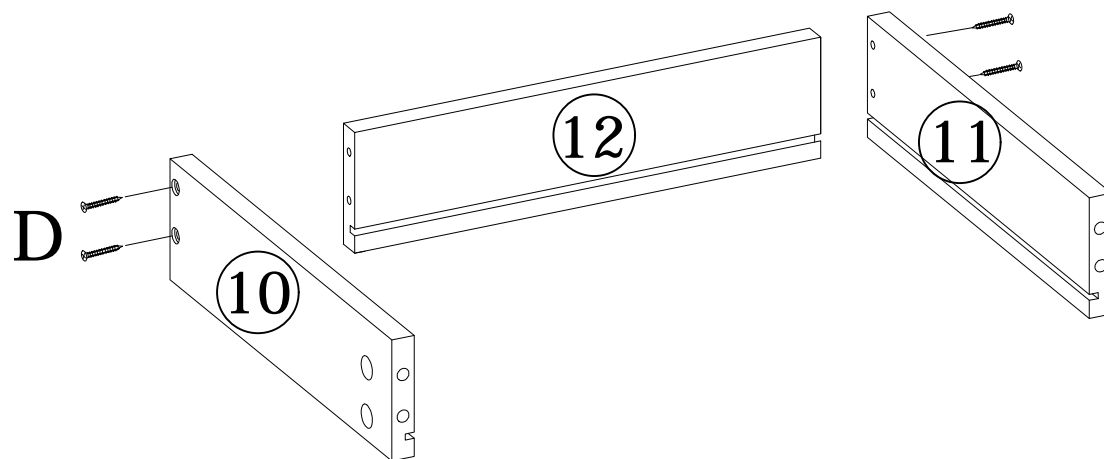

D × 4PCS

STEP 12

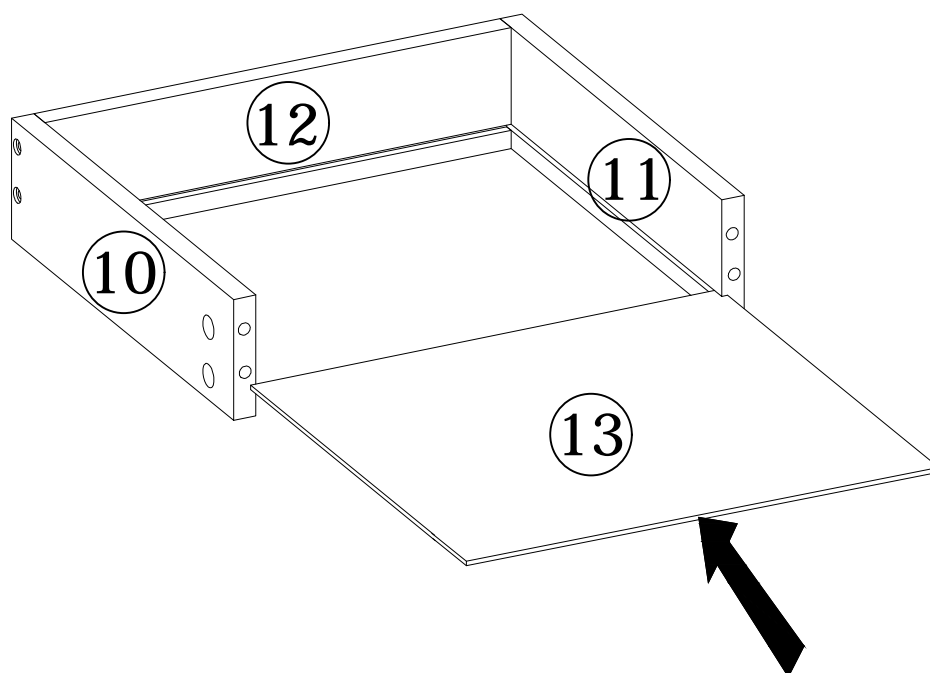

X4

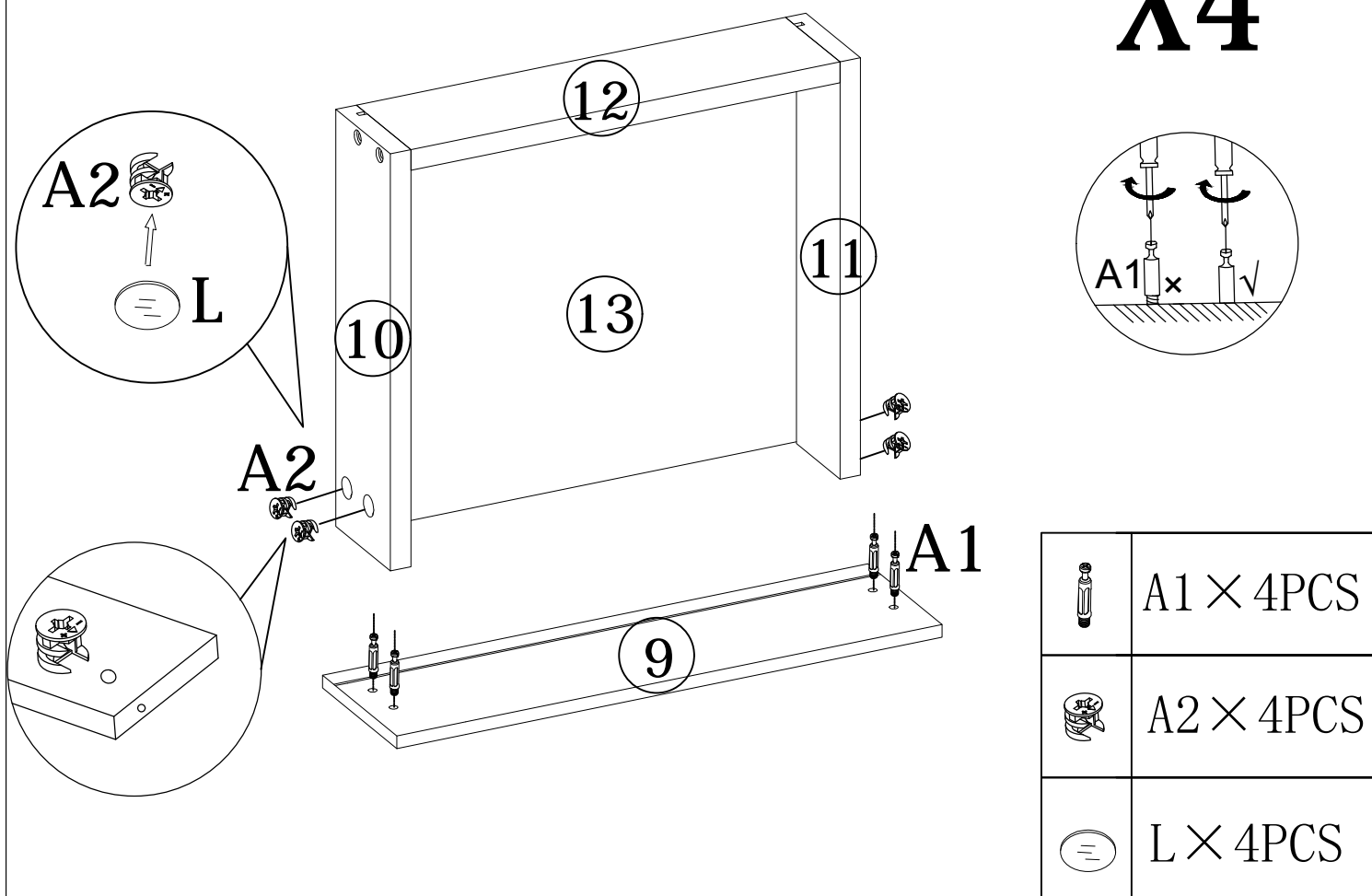

STEP 13

X4





	A1 × 4PCS
	A2 × 4PCS
	L × 4PCS

STEP 14

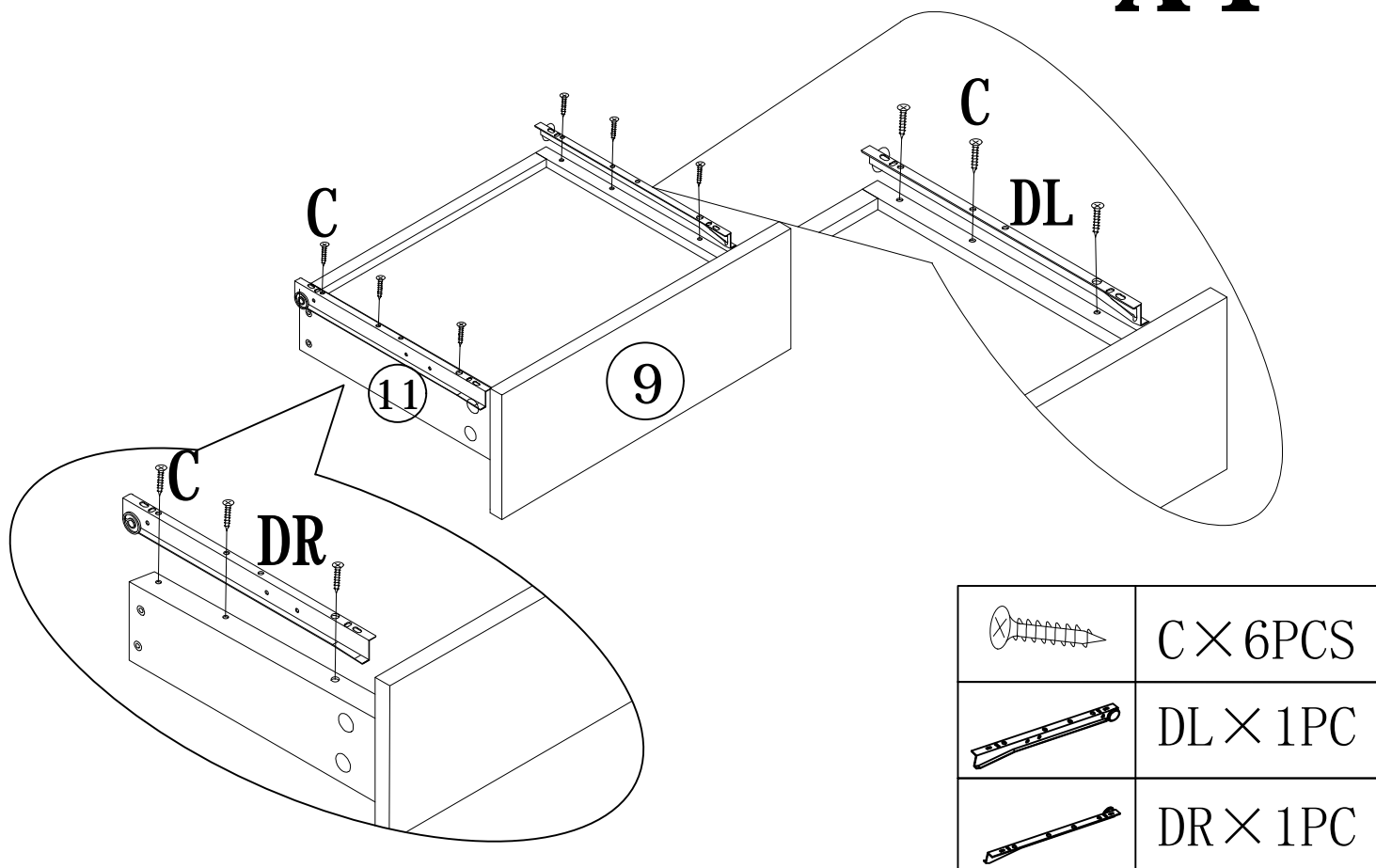

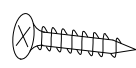
X4

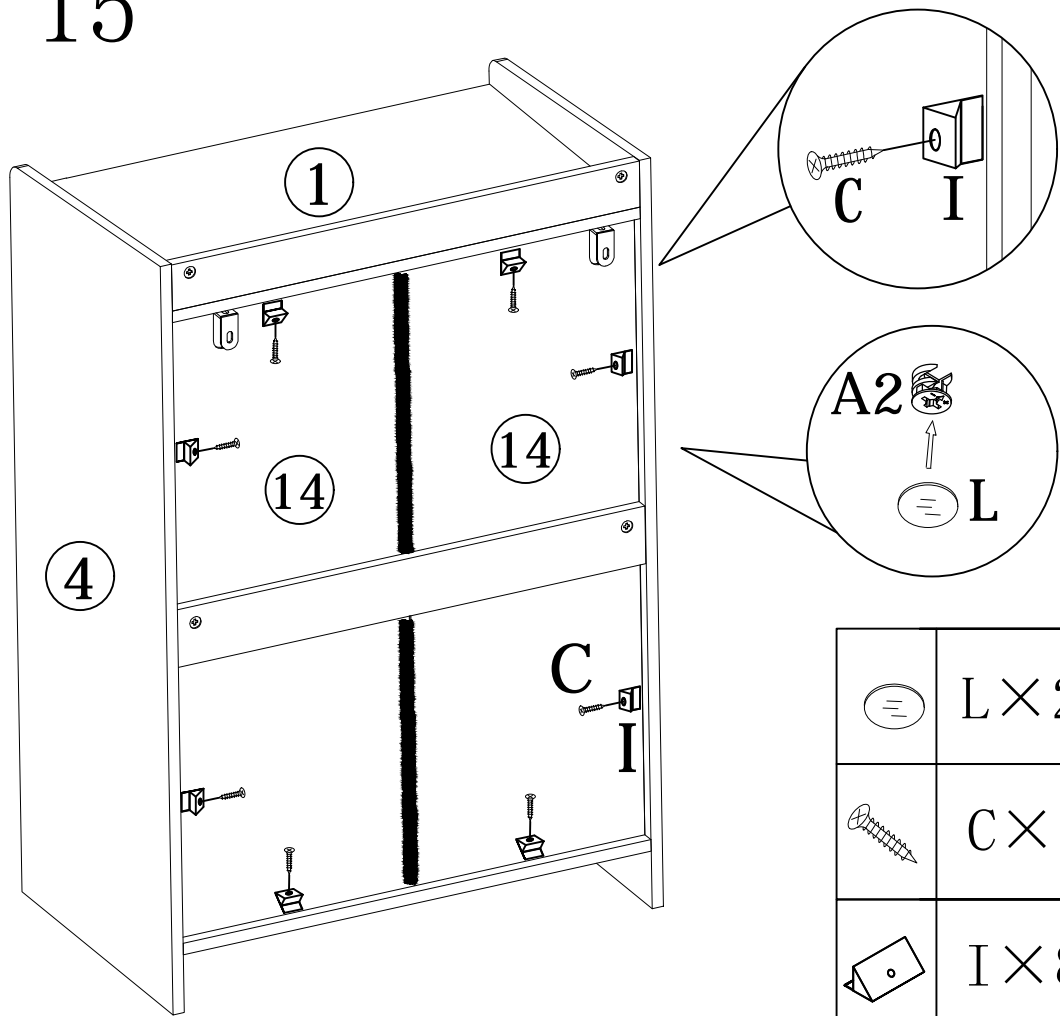

	C × 6PCS
	DL × 1PC
	DR × 1PC

STEP 15



	L × 20PCS
	C × 8PCS
	I × 8PCS

STEP 16

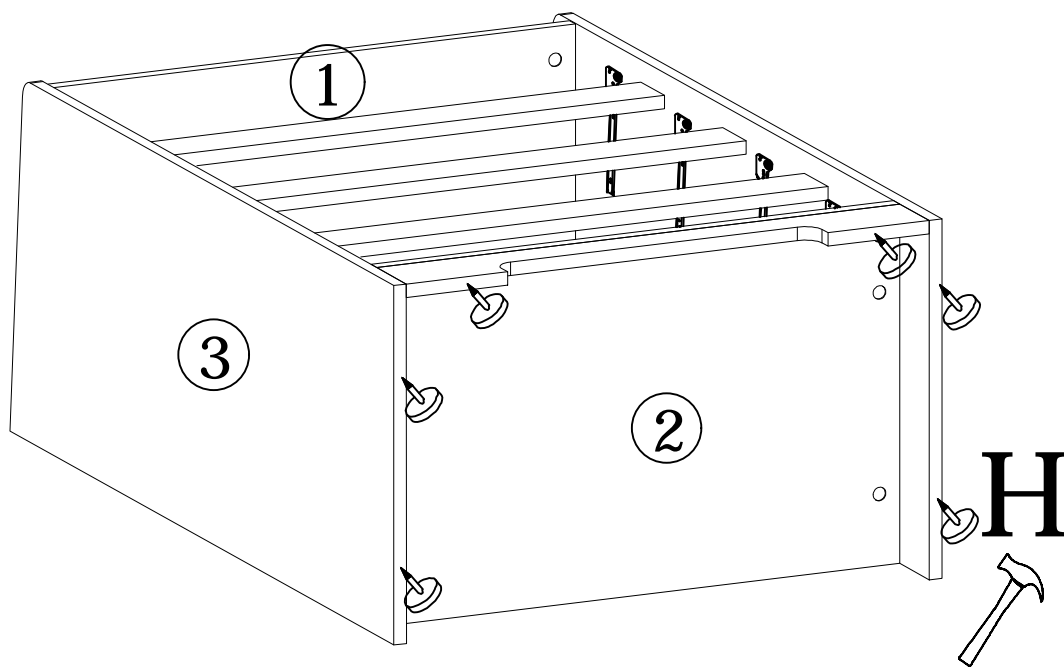

	H × 6PCS
---	----------

STEP 17

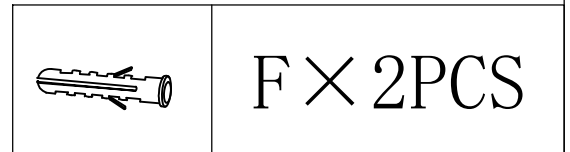
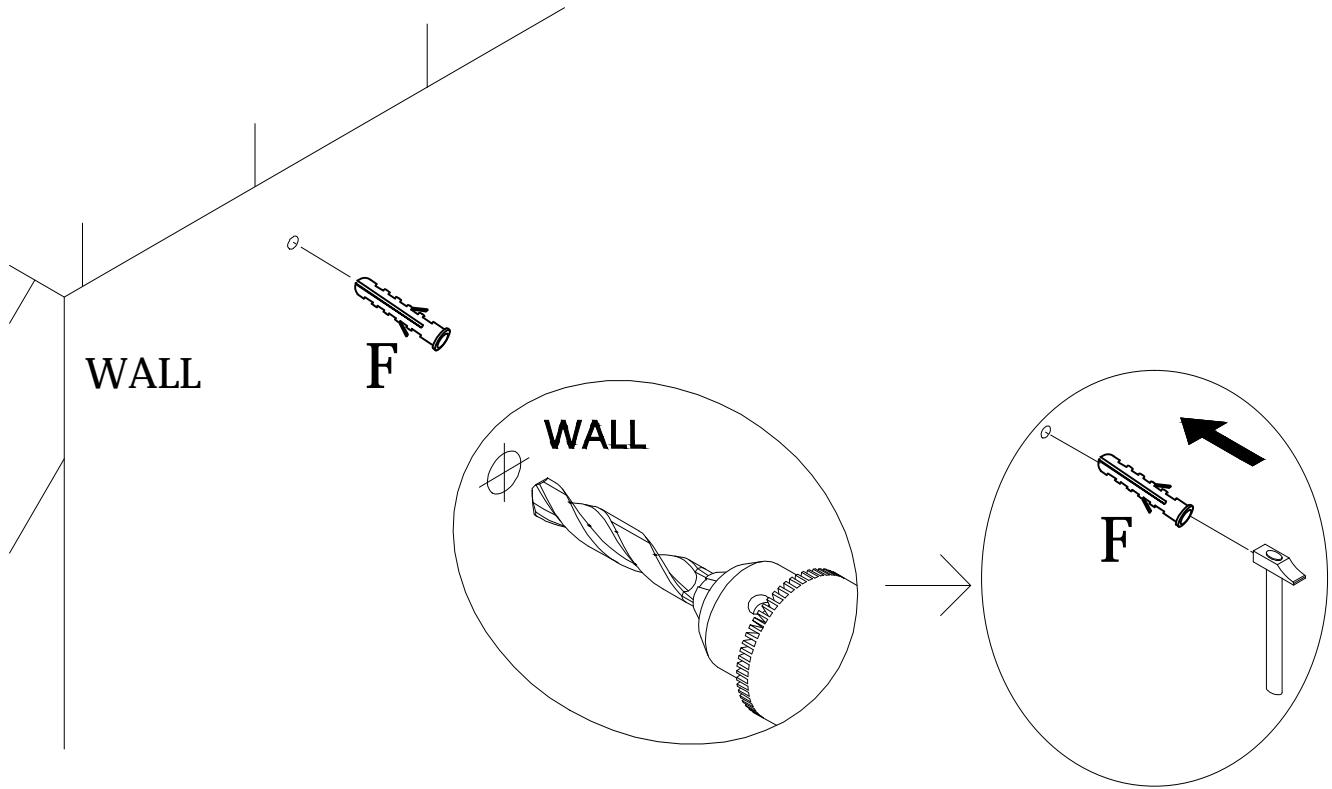

STEP 18

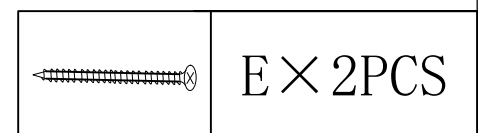
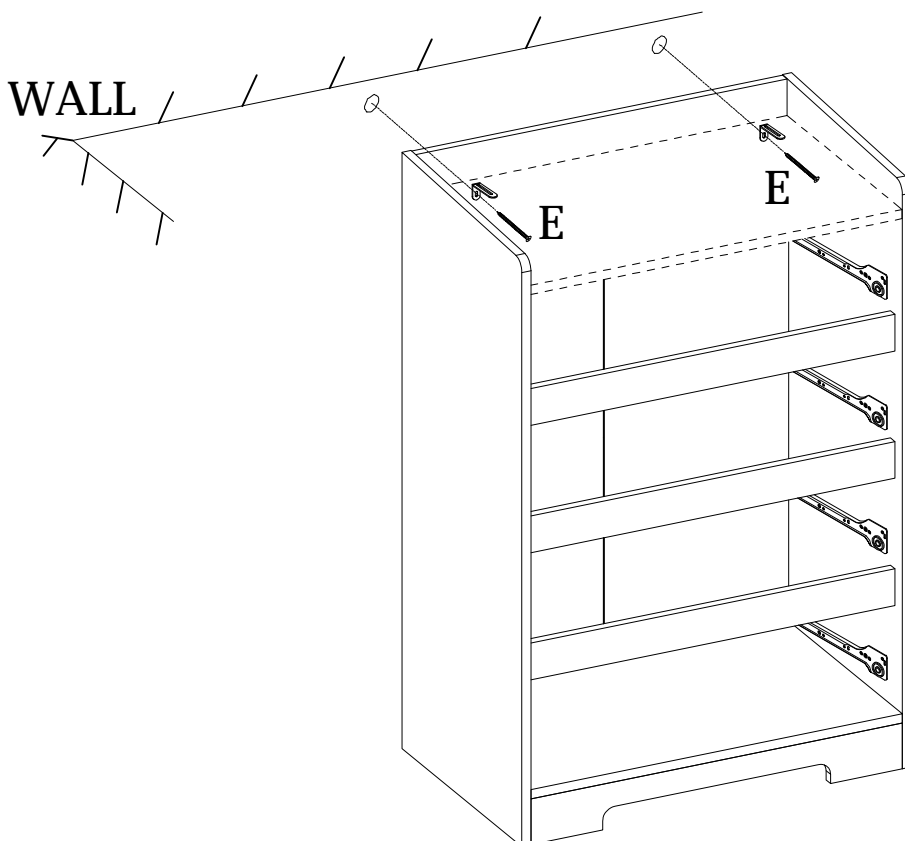

STEP 19

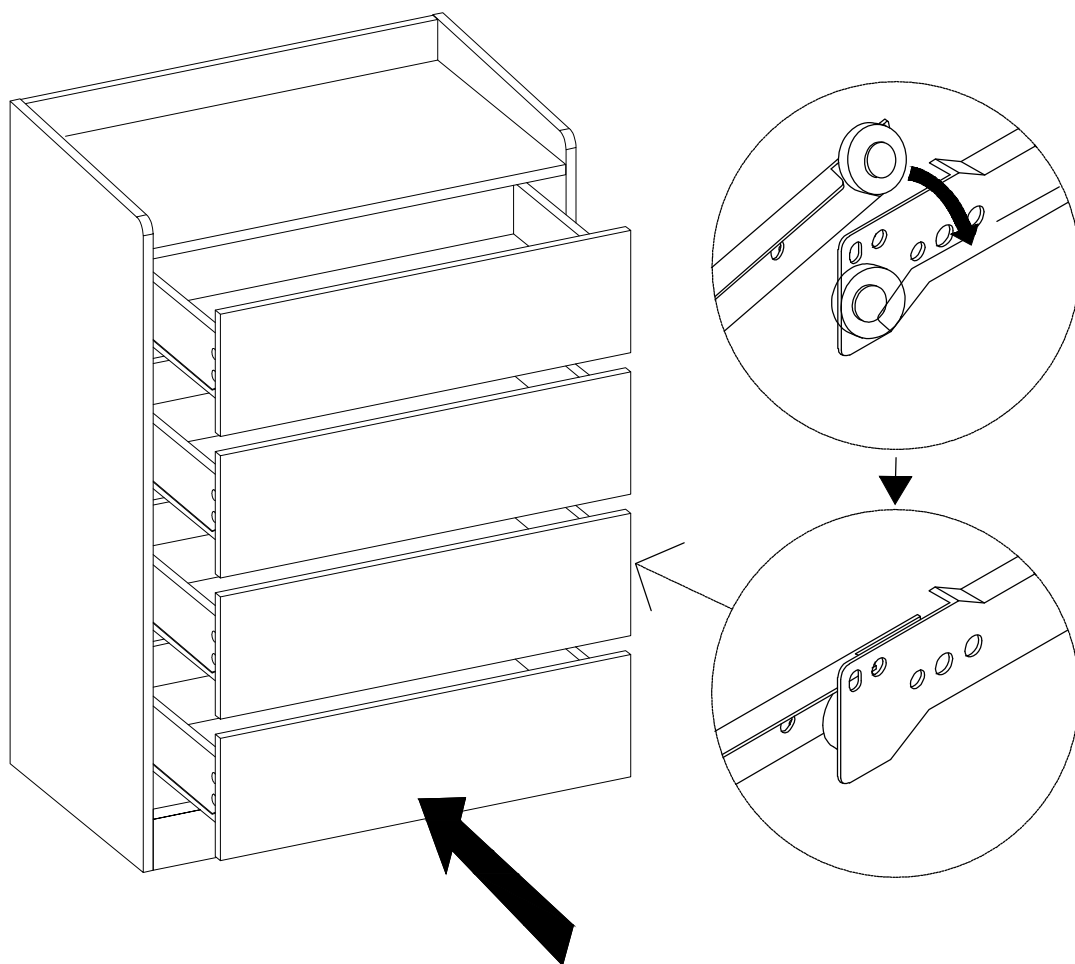

END

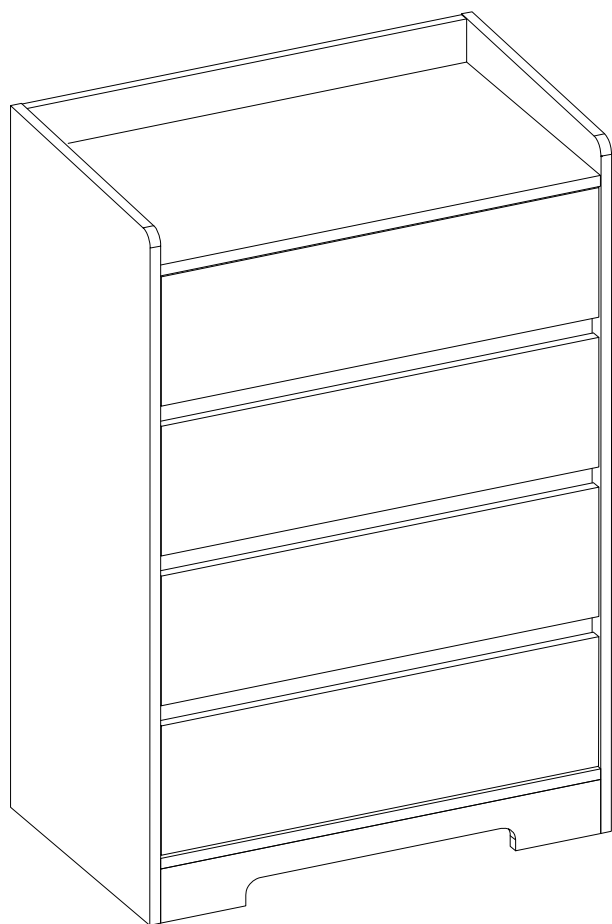

IMPORTANT-READ CAREFULLY-RETAIN FOR FUTURE REFERENCE

WARNING:

- Children must stay away from the assembly zone, preventing children from potential asphyxia because of plastic bag and foam breathing in nose;
- For your safety, please do not tread or climb product.
- The loading weight shall be within the range that vendor claims. The product is designed for adults use, domestic use and indoor use only.
- The product shall not combine with other product for use.
- If the product with seat height adjustments with energy accumulators that only trained personnel may replace or repair seat height adjustment components with energy accumulators
- Check regularly that all assembly fastenings are properly tightened, do not use the product if any structural part is broken or missing
- Incorrect installation and incorrect use can cause accidents. Please completely follow the guidance of assembly instruction.

Security instructions:

- Before assembling check whether all parts listed in the parts list have been delivered. Do not start assembling if parts are missing or damaged.
- A failure to assemble this product correctly could cause damage or result in serious injury! Before assembling make sure that you have enough space for the procedure. Assemble on a flat surface.
- Keep the assembly instructions available at all times and follow each of the individual steps exactly.
- During assembly, be careful with all the parts of the assembly (do not walk on them or distort them) and beware of shearing and trapping risks. Keep children and pets away while setting up the furniture.