

WARNING!!

NEVER allow children to climb or hang on furniture, including drawers or cabinet doors.

In addition to installing the restraints, to help prevent tip-over

- 1. NEVER put a TV or other heavy objects on top of this product".**
- 2. Do not stand on the product.**

▲ WARNING	
	<p>Children have died from furniture tipover. To reduce the risk of furniture tipover:</p> <ul style="list-style-type: none">• ALWAYS install tipover restraint provided.• NEVER put a TV on this product.• NEVER allow children to stand, climb or hang on drawers, doors, or shelves.• NEVER open more than one drawer at a time.• Place heaviest items in the lowest drawers.• Do not defeat or remove the drawer interlock system.
	<p><i>This is a permanent label. Do not remove!</i></p>

Assembly Instructions

Caution : You must read this before you proceed



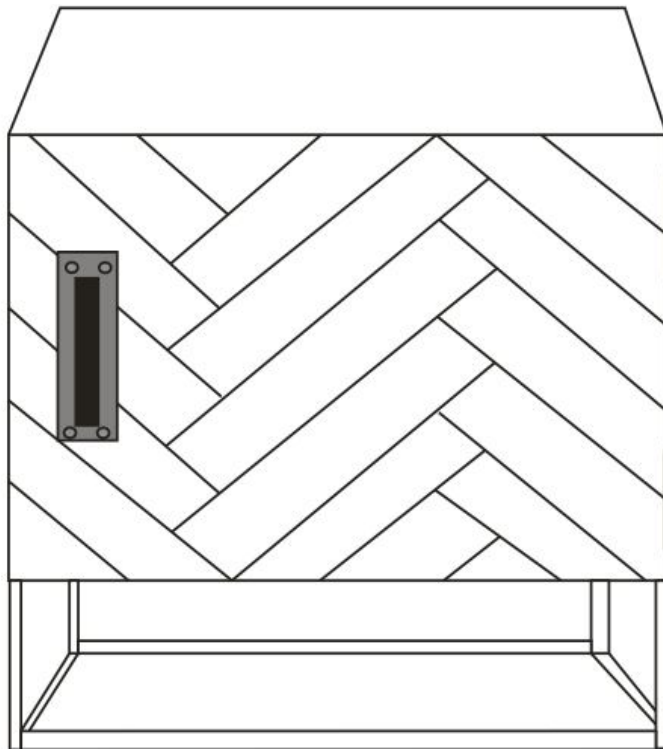

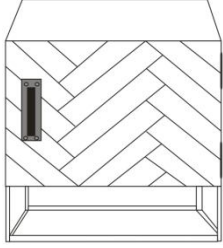

BEDSIDE

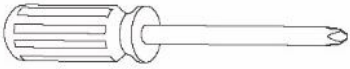
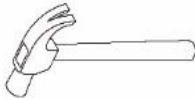

Parts List

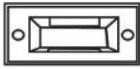
Label	Picture	Description	QTY
A		Bedside	1

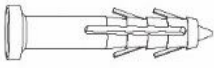
Hardware

Label	Picture	Description	QTY
①		Screwdriver (Not provided)	1
②		Hammer (Not provided)	1
③		Power Drill (Not provided)	1
④		Bracket	2
⑤		Wall Plug Screw (M8x50 mm)	4
⑥		Wall Plug (10x45 mm)	4
⑦		Tipover Restraint Straps	2

Assembly Preparation

Before
Beginning
Assembly:

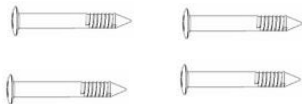
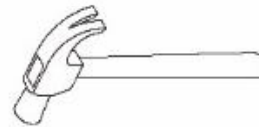
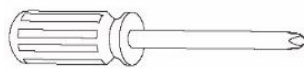
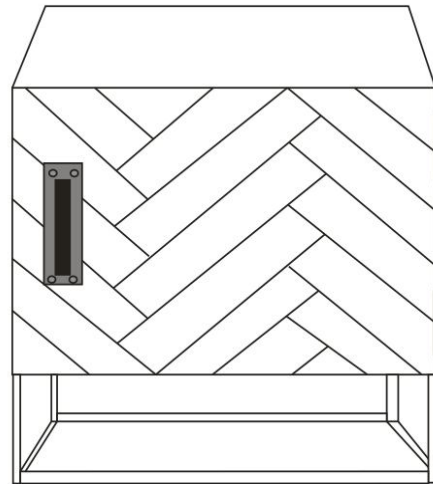
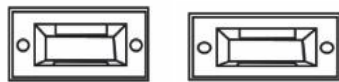

- Read instructions, cover to cover-



- Have 2 adults on hand for assembly-



- Do not assemble on flooring or carpet-



- Assemble on a clean non-marring surface (packing foam)-



- Save all packaging until finished-

Tipover Restraint Device Installation Instructions



Serious or fatal crushing injuries can occur from tipping furniture.

To help prevent tip-over: ALWAYS secure this furniture to the wall using Tipover Restraint Device.

See product instructions for more ways to help prevent furniture tip-over.

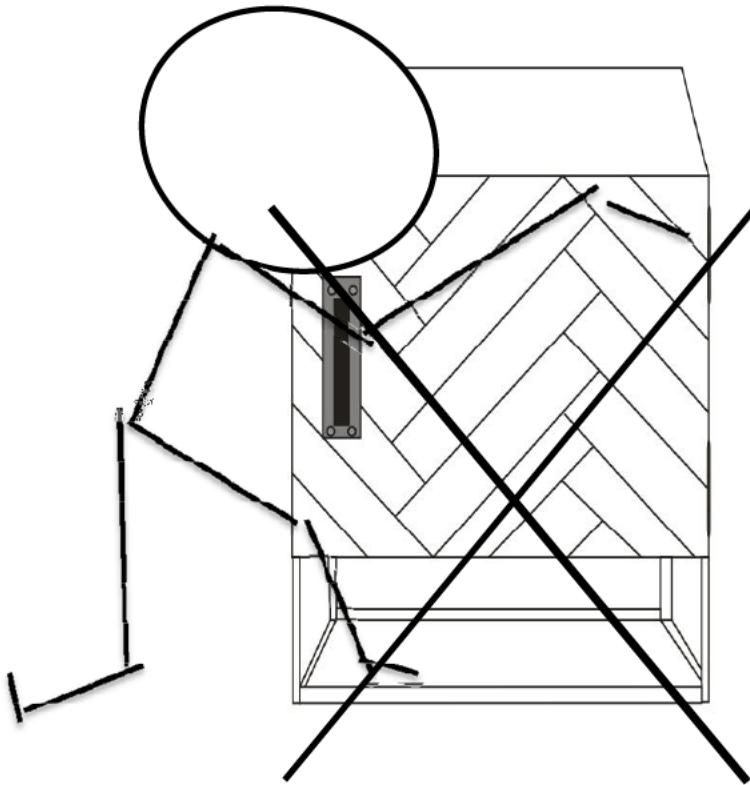

Usage For Tipover Restraint Device:

To secure Bedside against wall, attach two Brackets (④) on wall and product, use Tipover Restraint Straps (⑦) to connect the Brackets (④) .

Step 1

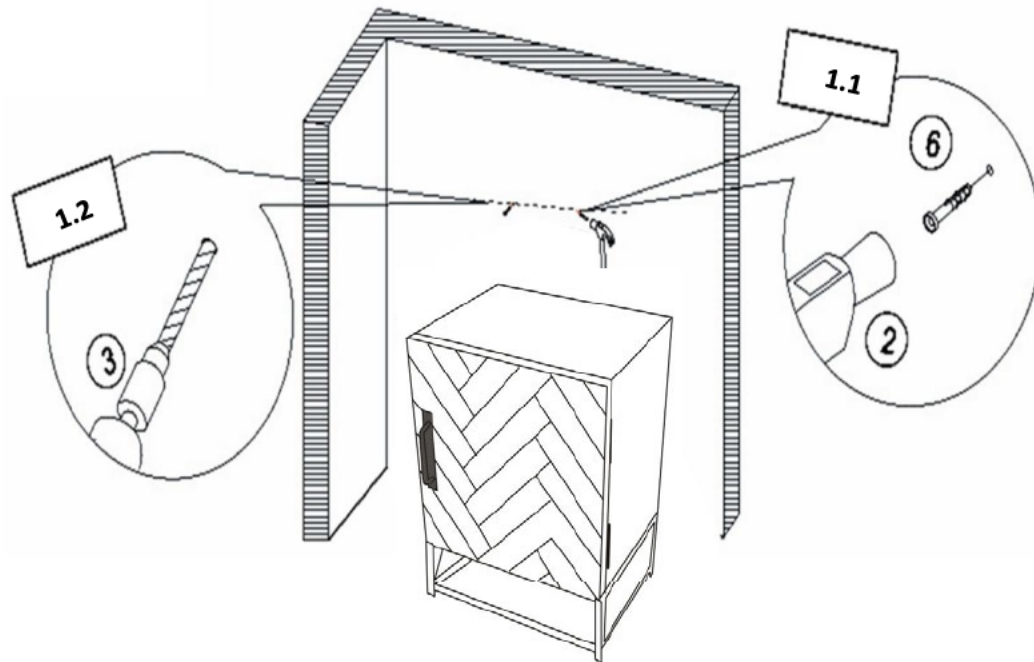

4.1) Drill two holes on wall at same height as Brackets ((4)) on Bedside with Power Drill ((3)).

You can mark these points in two ways as below:

1) Move the Bedside back to the wall. Mark two points same height as Bedside on the wall.

Note: The Brackets need to be secured to solid, load bearing surface. Please use a Stud Finder(not supplied) if needed to locate the Wall Frame.

2) Measure the height of the Brackets ((4)) with ruler/measuring tape and mark on wall to keep them accurate and same height.

4.2) Insert Wall Plugs ((6)) into drilled holes on wall with Hammer ((2)).

Step 2

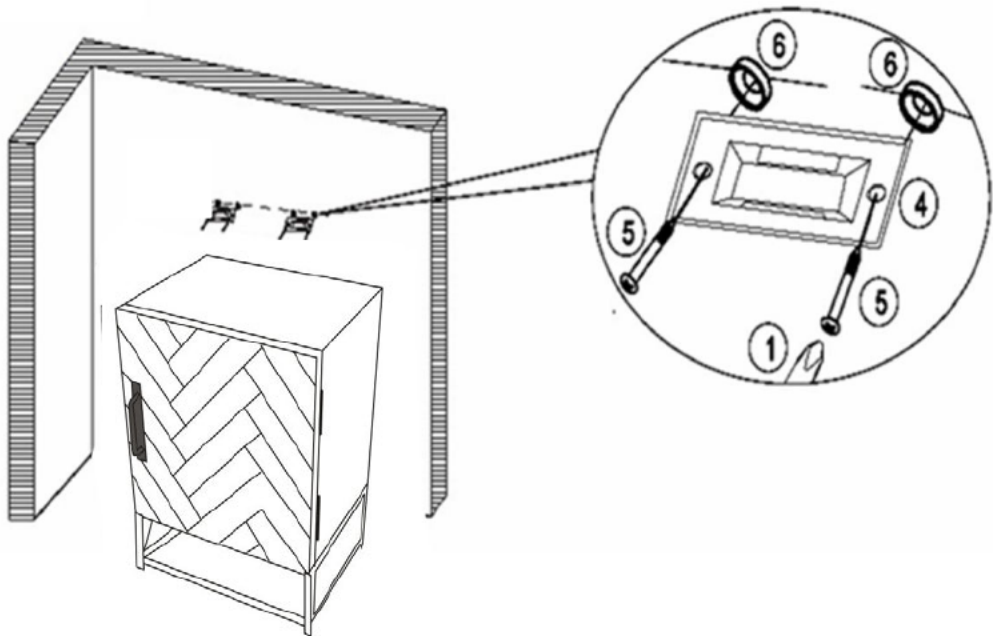

Attach Brackets (④) to Wall Plugs (⑥) using Wall Plug Screws (⑤) with Screwdriver (①).

Step 3

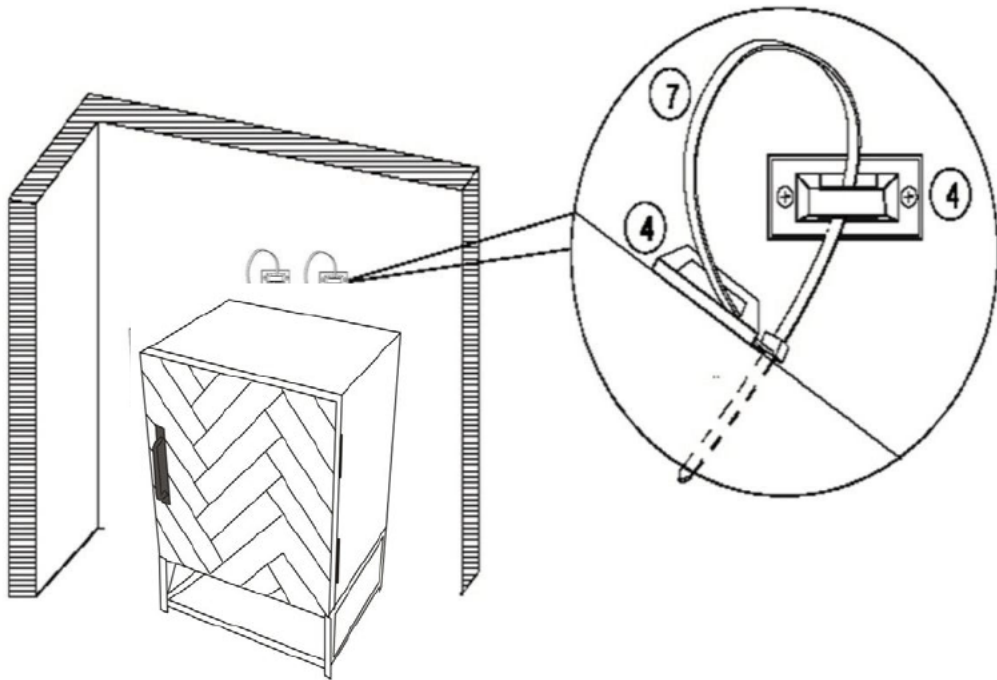











Move Bedside to the wall.

the wall and Bedside one by one, and pull the Tipover Restraint Straps (7) tight.

This Bedside is now ready to use.

Caution: This Bedside can only be used on flat, level surface.

Care & Maintenance

- ✓  • Furniture may scratch floors. We recommend using furniture pads to protect your floors.
- ⊘  • Do not put hot items directly on furniture surface
- ⊘  • Do not clean furniture with harsh cleansers or polish.
- ⊘  • Do not place furniture under direct sunlight.
- ⊘  • Do not place furniture near heating or cooling vents.
- ⊘  • Do not write on furniture without a passed banner to protect the surface.
- ⊘  • Do not place furniture outside. for indoor use only.
- ⊘  • Not for commercial use. for residential use only.
- ⊘  • Stains may be removed with mild soap solution and damp cloth.
- ⊘  • Children should not climb or jump on the furniture.
- ✓  • Dust and pick - up shills using a clean, non-colored, lint-free cloth.