

Installation & Assembly

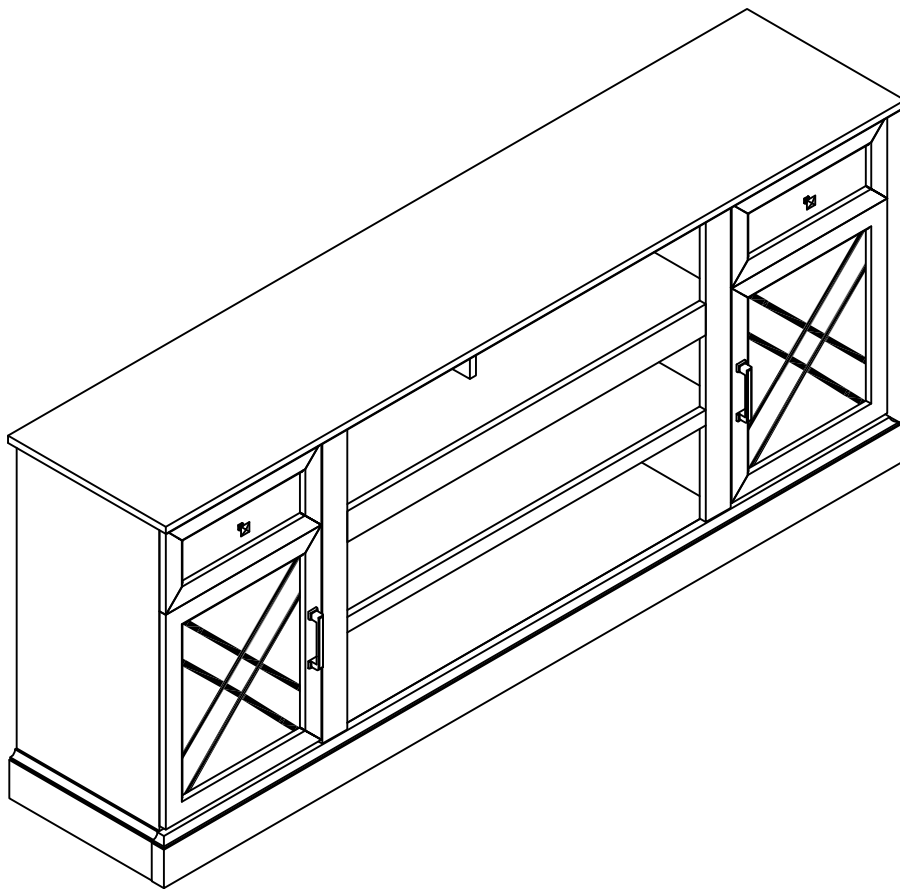

As this item contains many parts, please read the installation instruction carefully before installation . Please use tools properly and carefully. If you have any questions about the product and installation, please contact us.

Our professional after-sales team will serve you online all day.

Before You Start

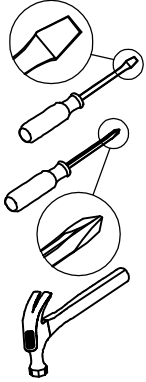

- ✓ Read through each step carefully and follow the proper order
- ✓ Separate and count all your parts and hardware
- ✓ Give yourself enough room for the assembly process
- ✓ Have the following tools: Flat Head Screwdriver, #2 Phillips Head Screwdriver and Hammer
- ✓ Caution: If using a power drill or power screwdriver for screwing, please be aware of to slow down and stop when screw is tight. Failure to do so may result in stripping the screw. (Assembly speed can be increased by using electric screwdriver)

Helpful Hints

PEOPLE NEEDED FOR ASSEMBLY: 1-2

- Open your item in the area you plan to keep it to avoid excessive heavy lifting.
- Identify, sort and count the parts before attempting assembly.
- Compression dowels are lightly tapped in with a hammer.
- Slides are labeled with an R (right) and L (left) for proper placement.
- Make sure to always face the point on the top of the Cam Lock towards the outer edge.
- If there is a back panel in the package, please install it to make sure your unit is complete and sturdy.
- Please fix all the screws provided for the back panel which can enhance product stability. If it is difficult to fix it when tightening, it can be fixed with the help of a hammer and then tightened.
- Do NOT use harsh chemicals or abrasive cleaners on this item.
- Never push, pull, or drag your furniture.



Board Identification

Not actual size

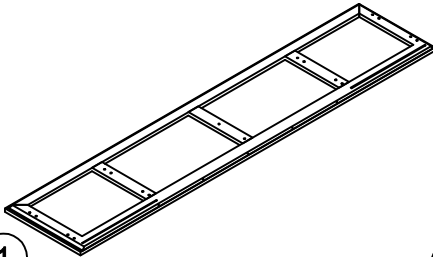

1

TOP
qty:1

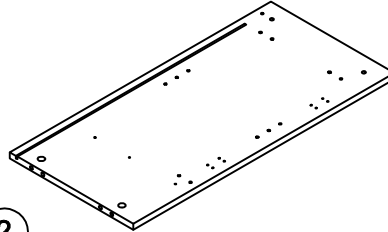

2

LEFT SIDE PANEL
qty:1

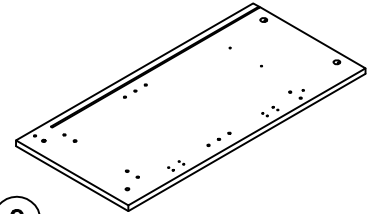

3

RIGHT SIDE PANEL
qty:1

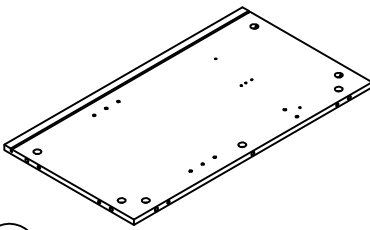

4

PARTITION PANEL
qty:1

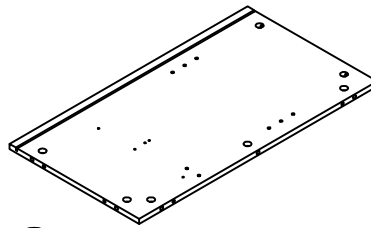

5

PARTITION PANEL
qty:1

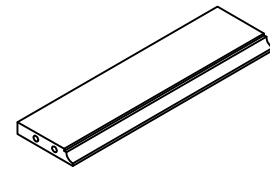

6

BOTTOM RAIL
qty:1

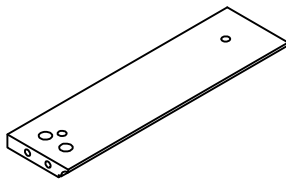

7

BOTTOM RAIL
qty:1

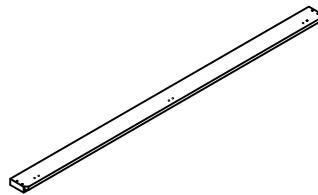

8

FRONT FOOT STRIP
qty:1

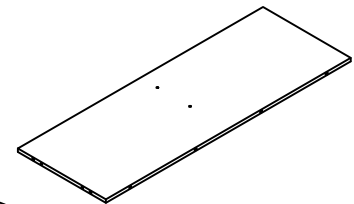

9

FIXED SHELF
qty:1

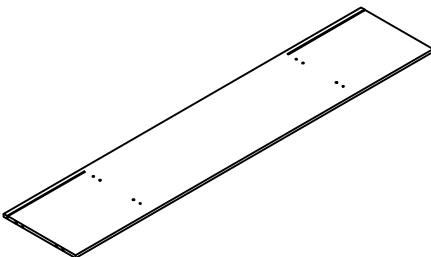

10

BOTTOM
qty:1

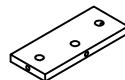

11

NEUTRAL BOARD
qty:1

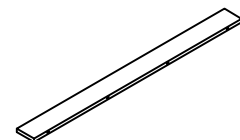

12

BOTTOM RAIL
qty:1

Board Identification

Not actual size

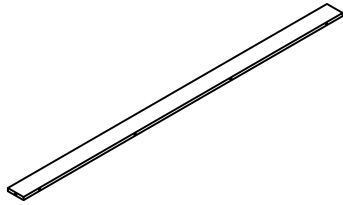

13
BOTTOM RAIL
qty:1

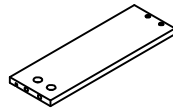

14
DRAWER LEFT PANEL
qty:2

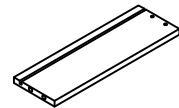

15
DRAWER RIGHT PANEL
qty:2

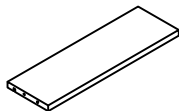

16
DRAWER BACK PANEL
qty:2

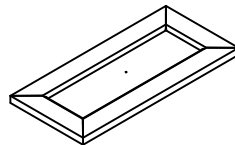

17
SMALL DRAWER FRONT
qty:1

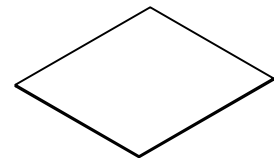

18
BOTTOM OF DRAWER
qty:2

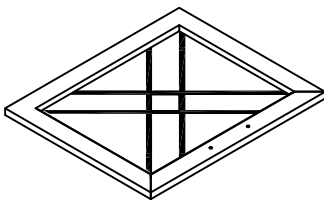

19
DOOR
qty:2

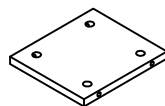

20
MIDDLE VERTICAL FOOT
qty:1

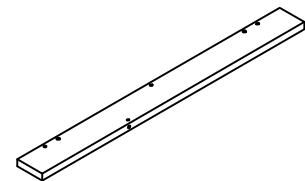

21
FRONT STANDING BOARD
qty:1

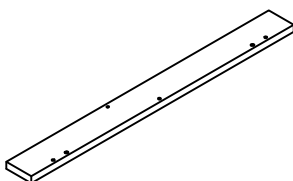

22
FRONT STANDING BOARD
qty:1

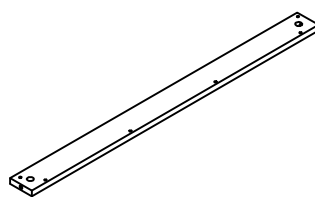

23
FRONT PULL STRIP
qty:1

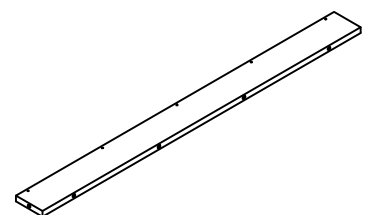

24
REAR PULL STRIP
qty:1

Board Identification

Not actual size

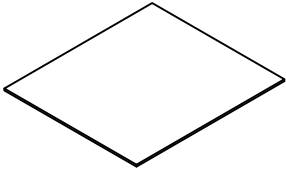

25
GLASS PLATE
qty:2

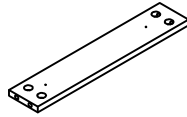

26
BRACE
qty:2

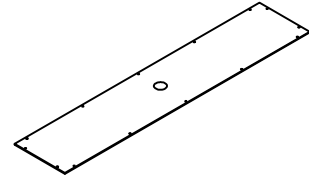

27
UPPER BACKPANEL
qty:1

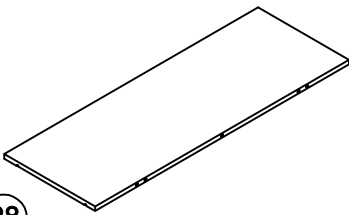

28
ADJUSTABLE SHELF
qty:1

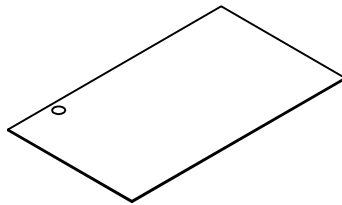

29
BACK BOARD
qty:2

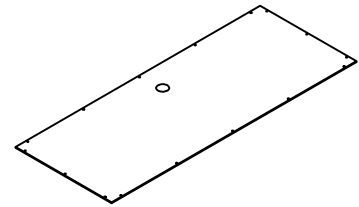

30
LOWER BACKPANEL
qty:1

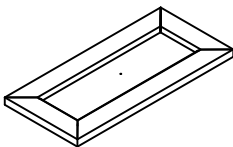

31
SMALL DRAWER FRONT
qty:1

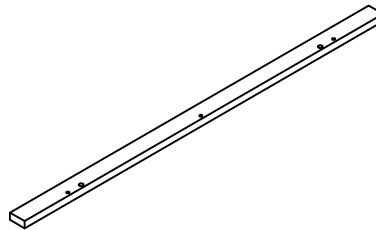

32
FRONT PULL STRIP
qty:1

Part List

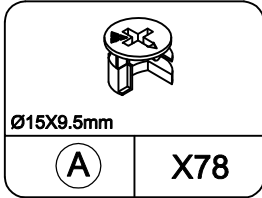

CAM LOCK
spare:3

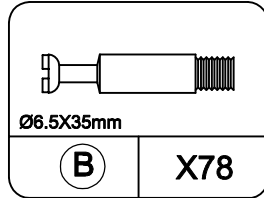

CAM BOLT
spare:3

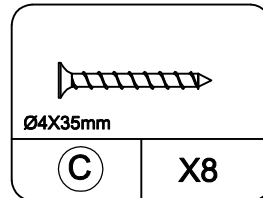

SCREW
spare:1

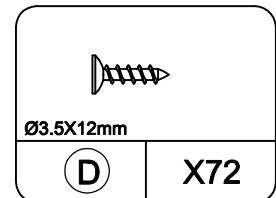

SCREW
spare:3

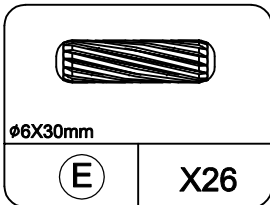

WOOD DOWEL
spare:2

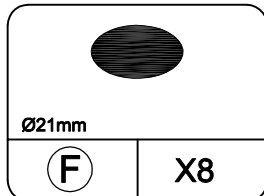

PERFECT STICKERS
spare:2

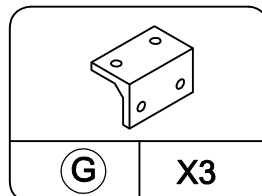

FLAP

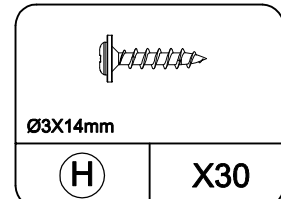

SCREW
spare:3

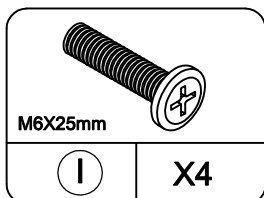

SCREW
spare:1

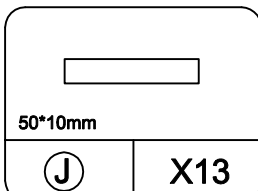

FLOOR-MATS
spare:2

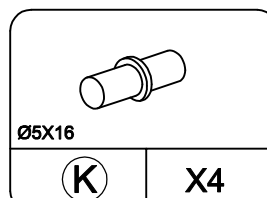

SHELF SUPPORT
spare:1

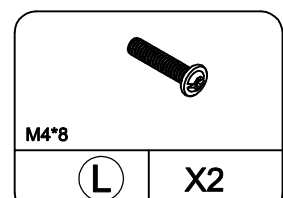

SCREW
spare:1

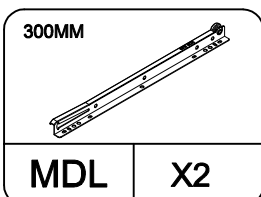

LEFT DRAWER RUNNER

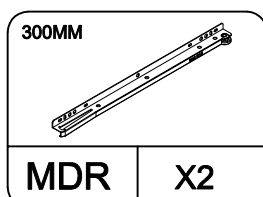

RIGHT DRAWER RUNNER

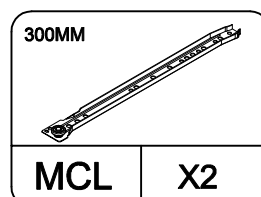

LEFT CABINET MEMBER

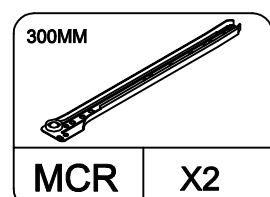

RIGHT CABINET MEMBER

Part List

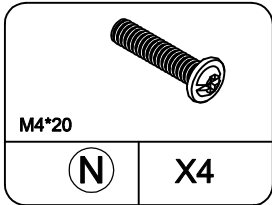

SCREW
spare:1

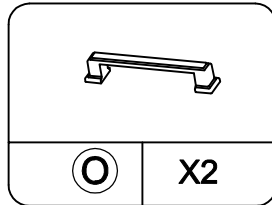

HANDLE

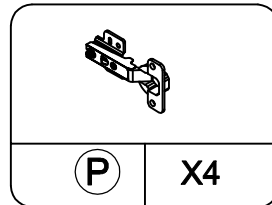

HINGE

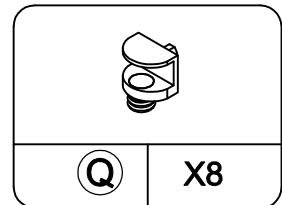

SHELF SUPPORT

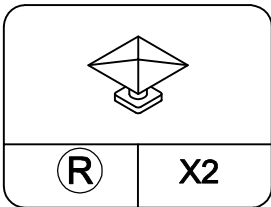

HANDLE

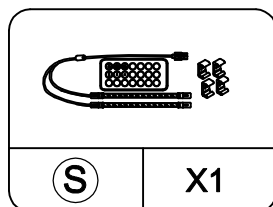

LIGHT BULB

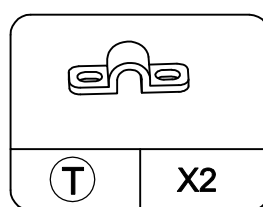

PLSTIC CABLE BUCKLE
spare:1

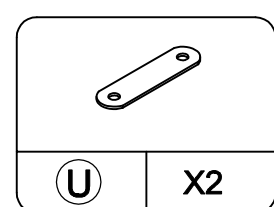

METAL PLATE

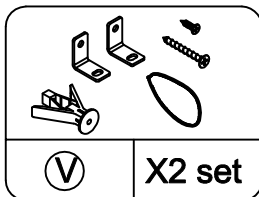

TIPPING RESTRAINT
HARDWARE KIT

Cam Lock Fastening System

Insert the cam bolt into the hole first, then insert the cam lock and lock it.

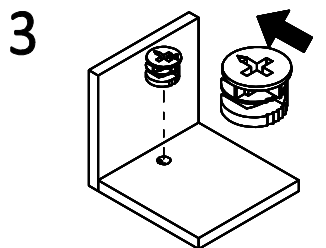
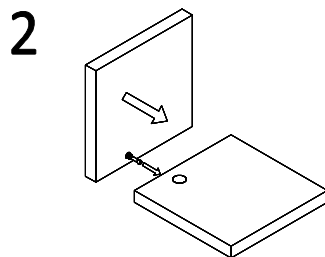
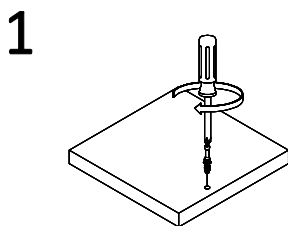

The opening must point toward the edge of the board

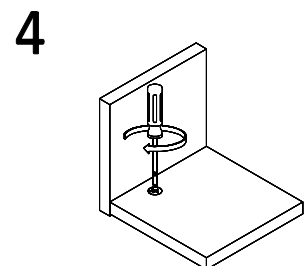

Board Identification

Not actual size

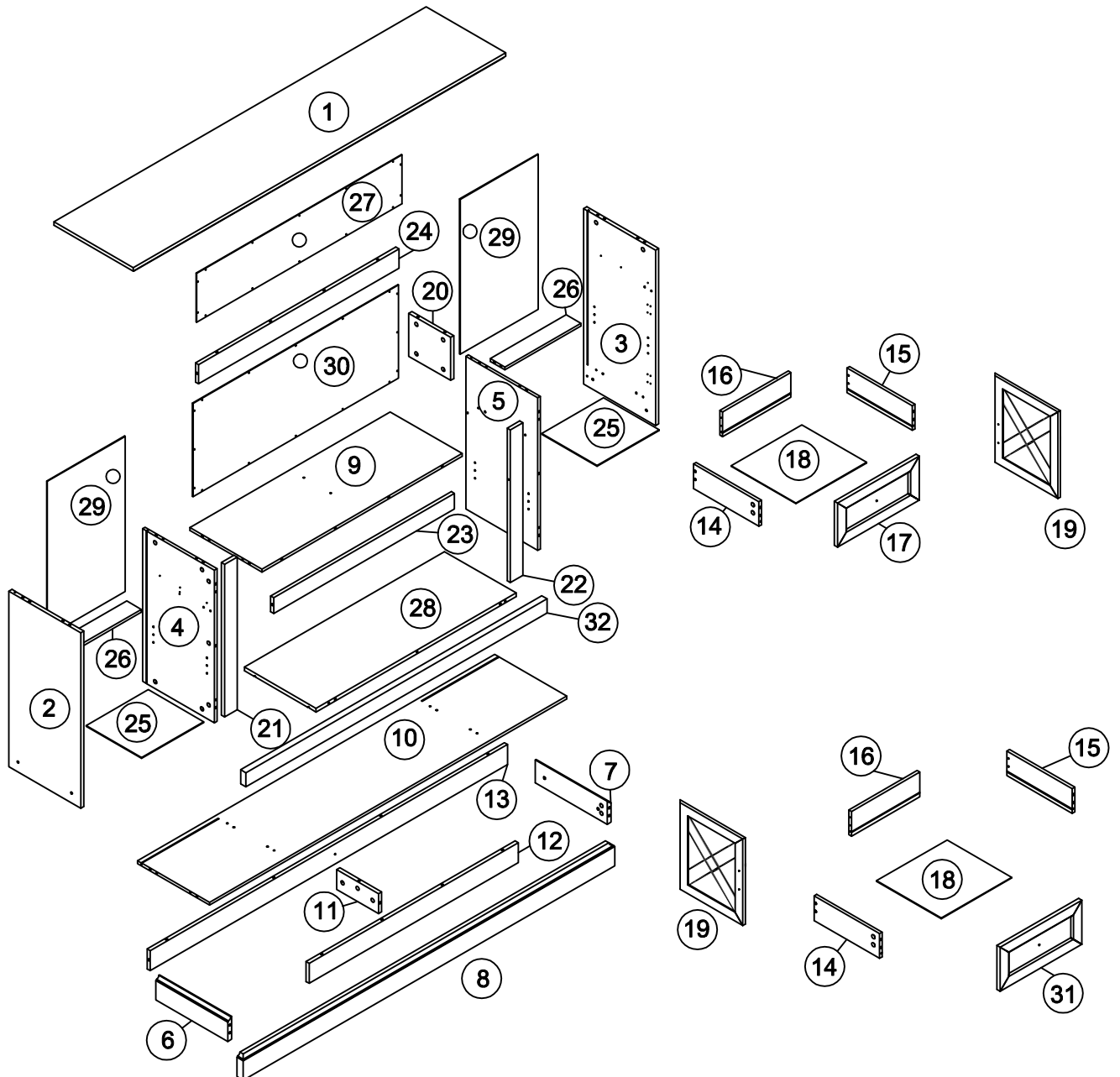

STEP 1

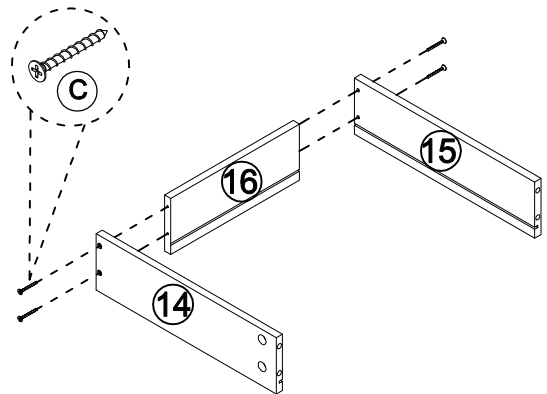
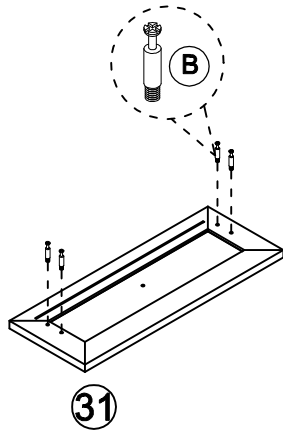
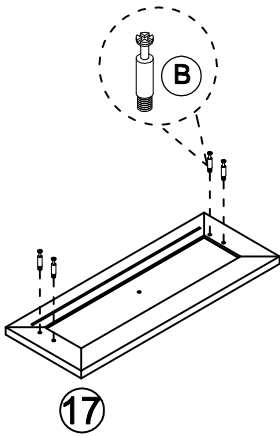
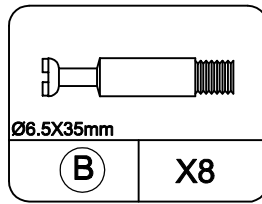
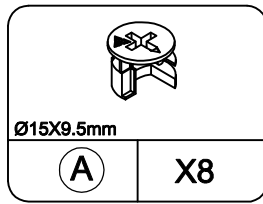
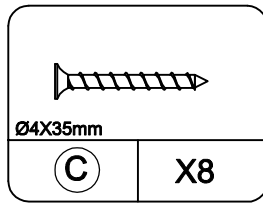
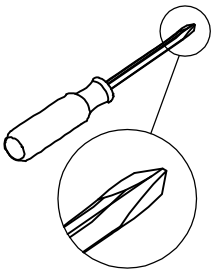

X 2

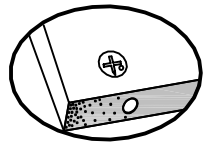
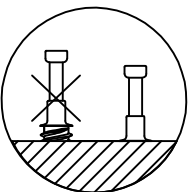
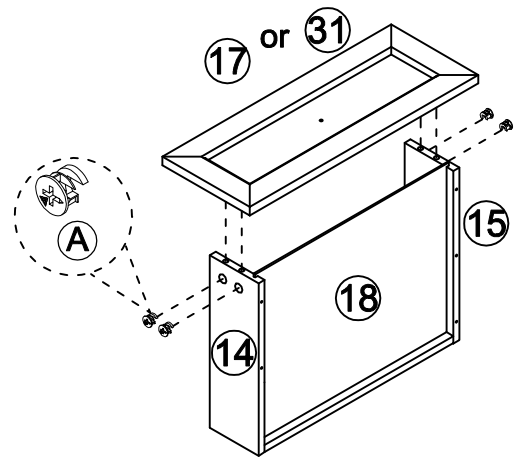
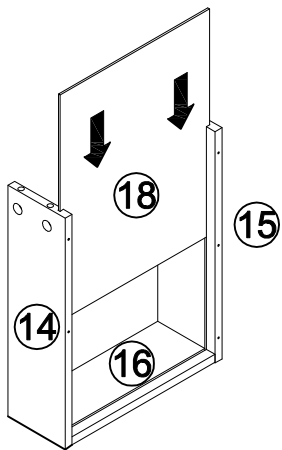

Proper orientation of CAM LOCK

STEP 2

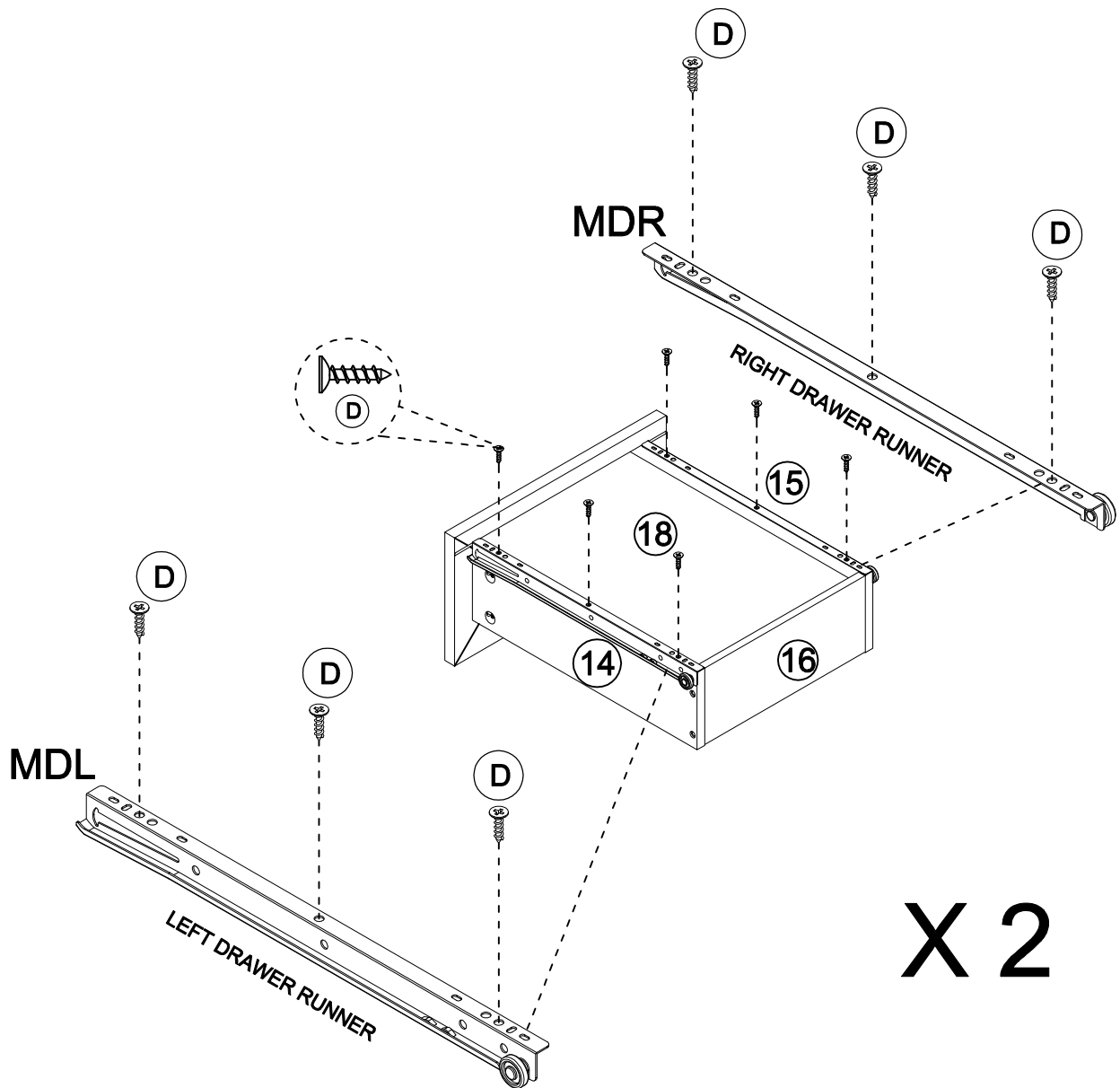
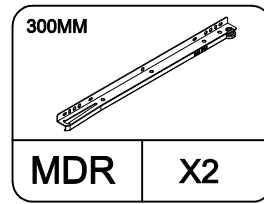
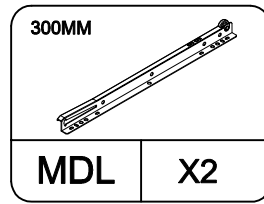
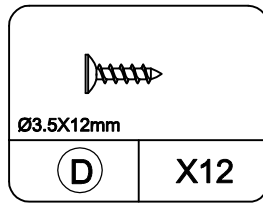
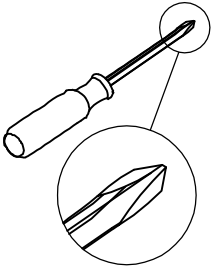

STEP 3

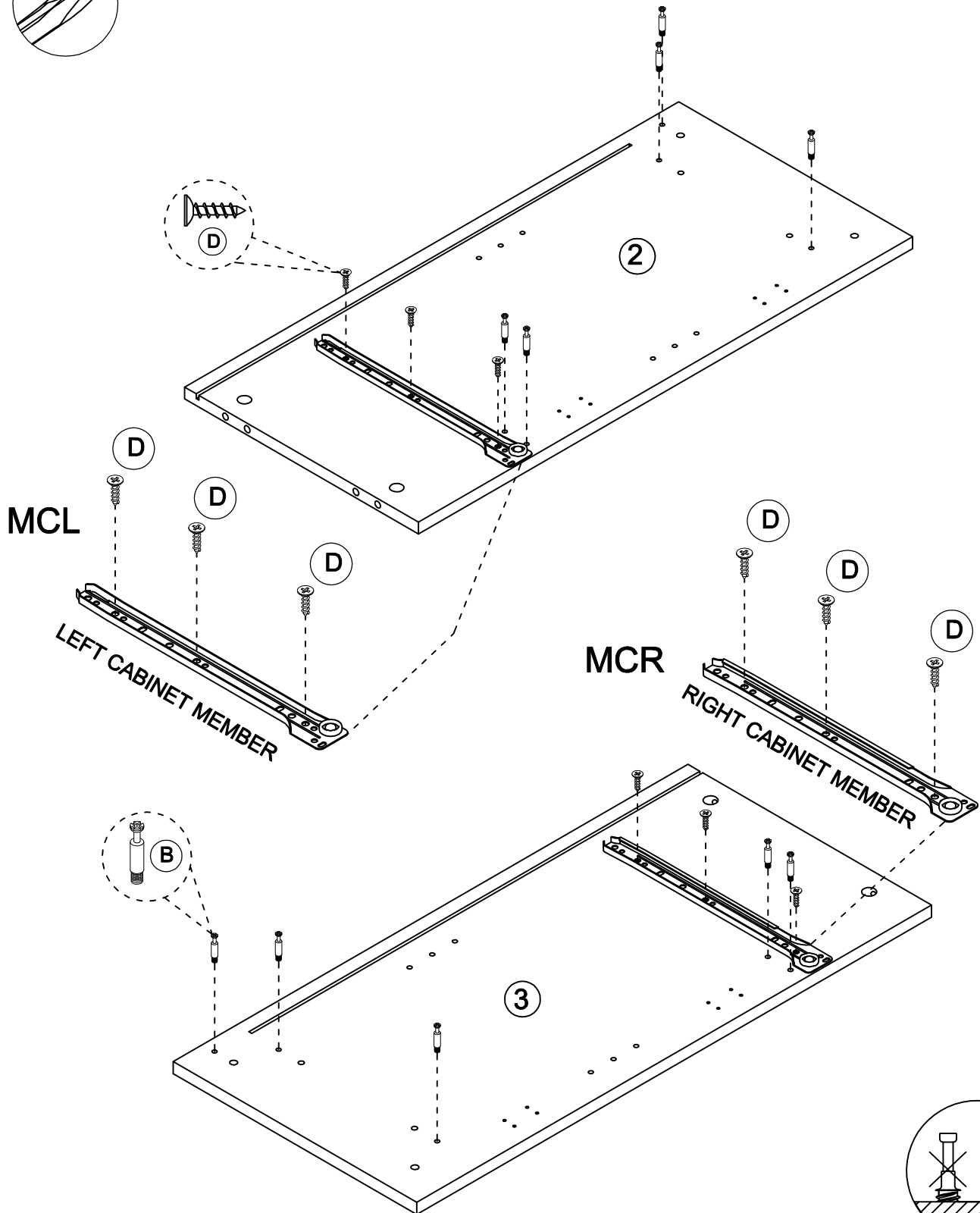
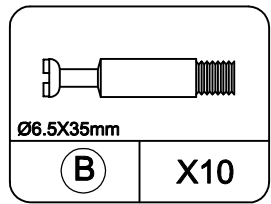
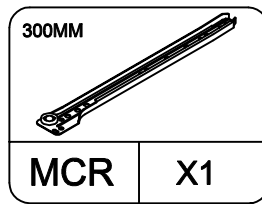
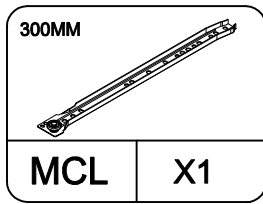
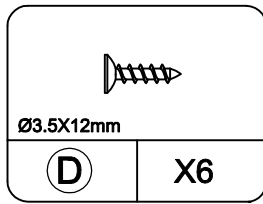
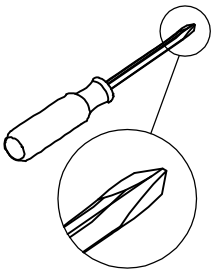

STEP 4

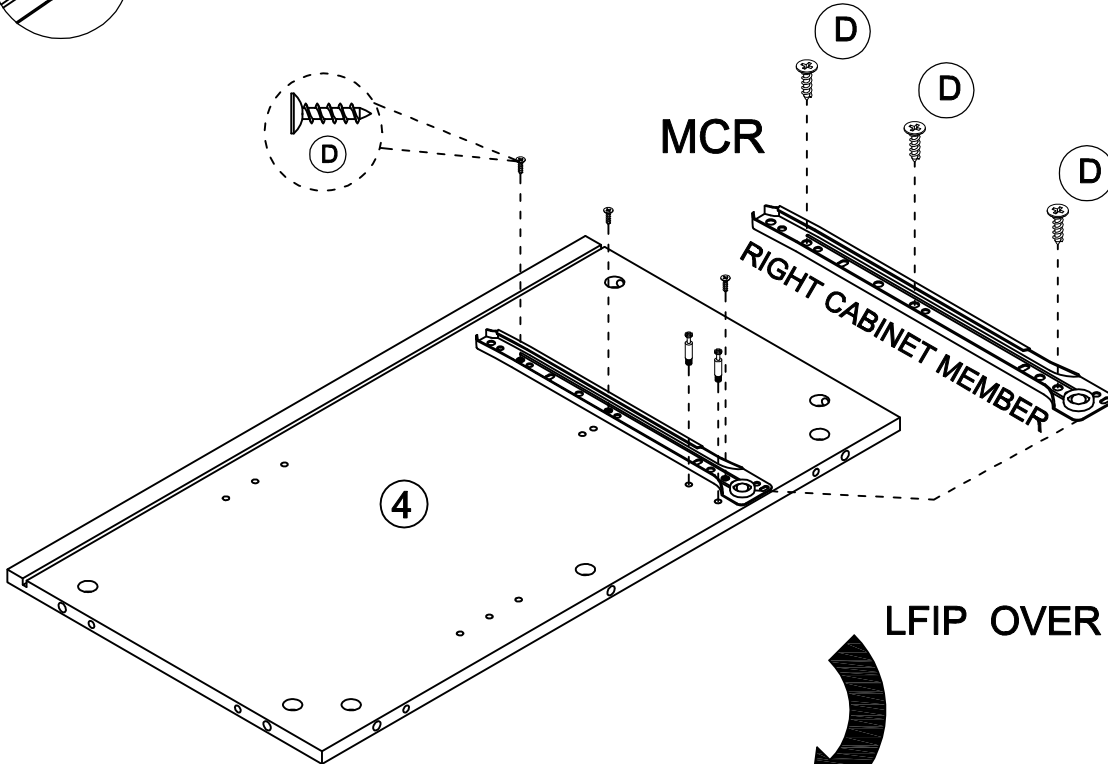
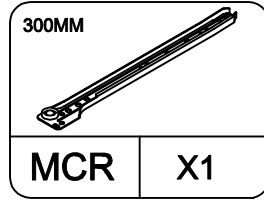
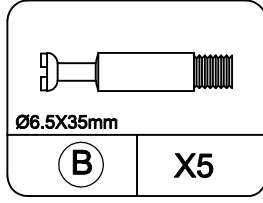
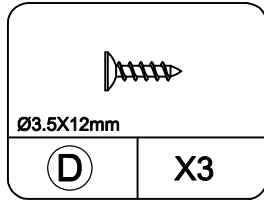
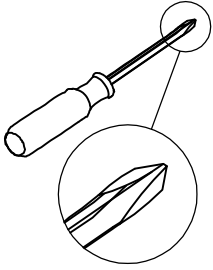

LFIP OVER

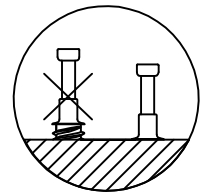
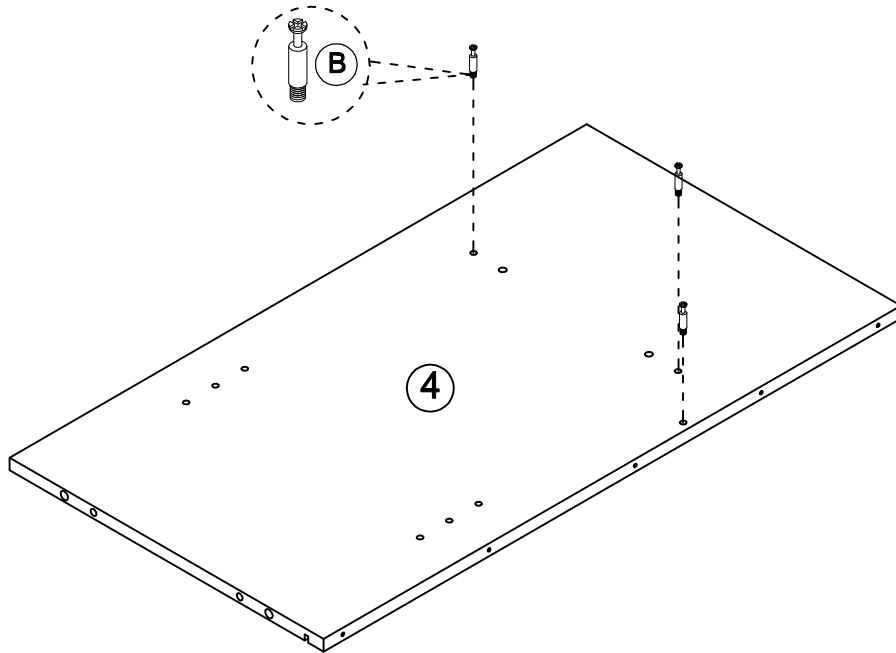

STEP 5

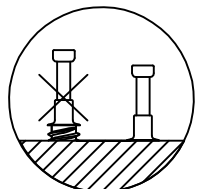
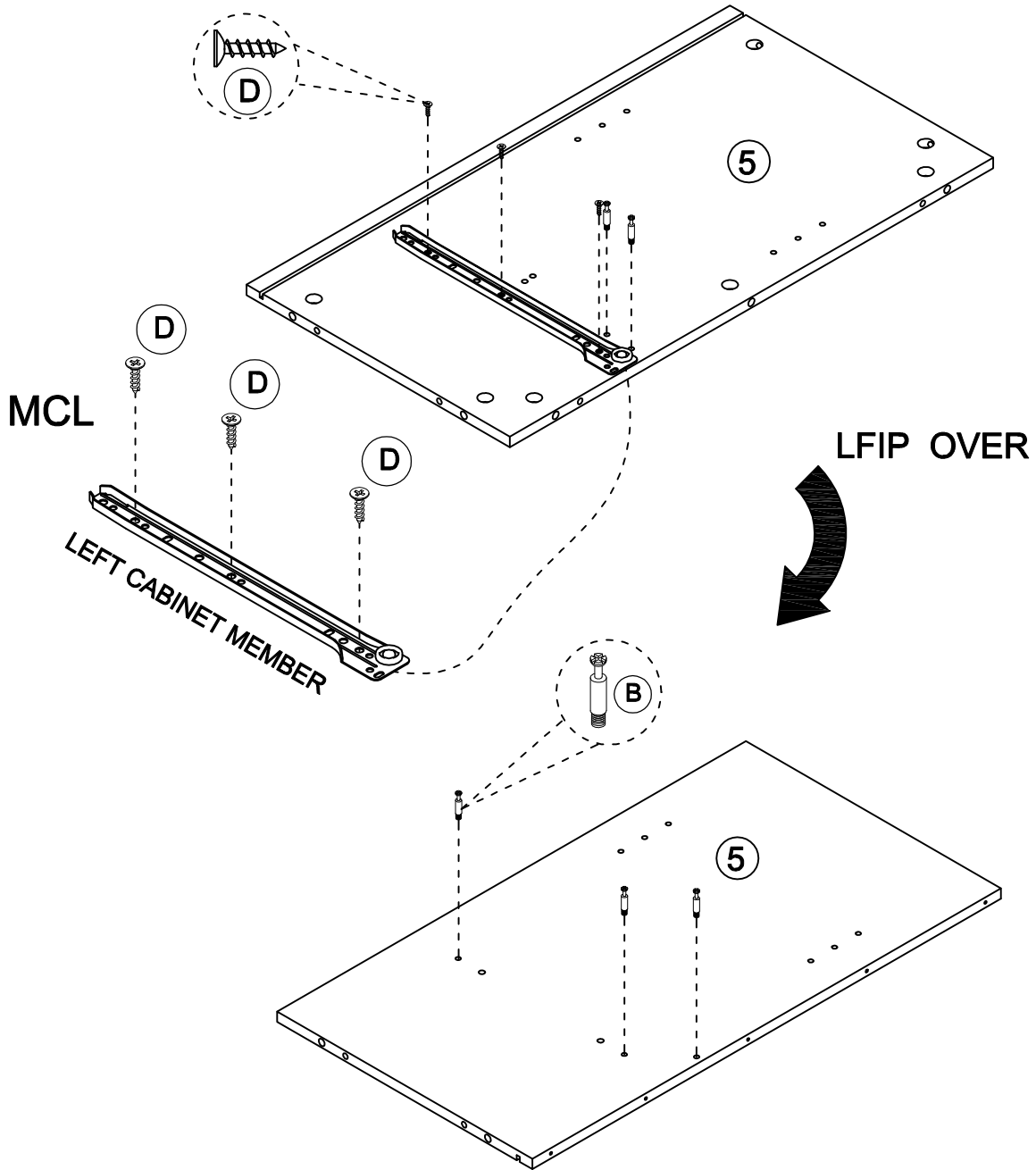
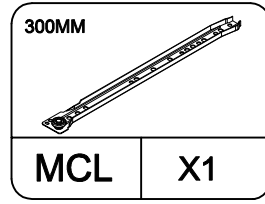
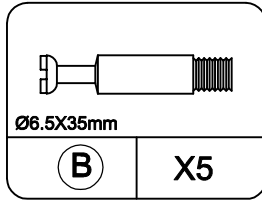
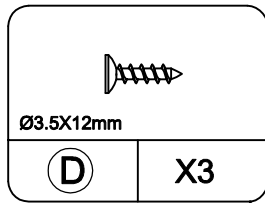
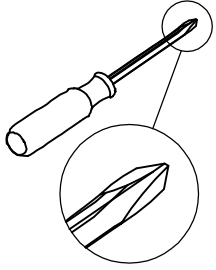

STEP 6

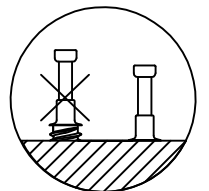
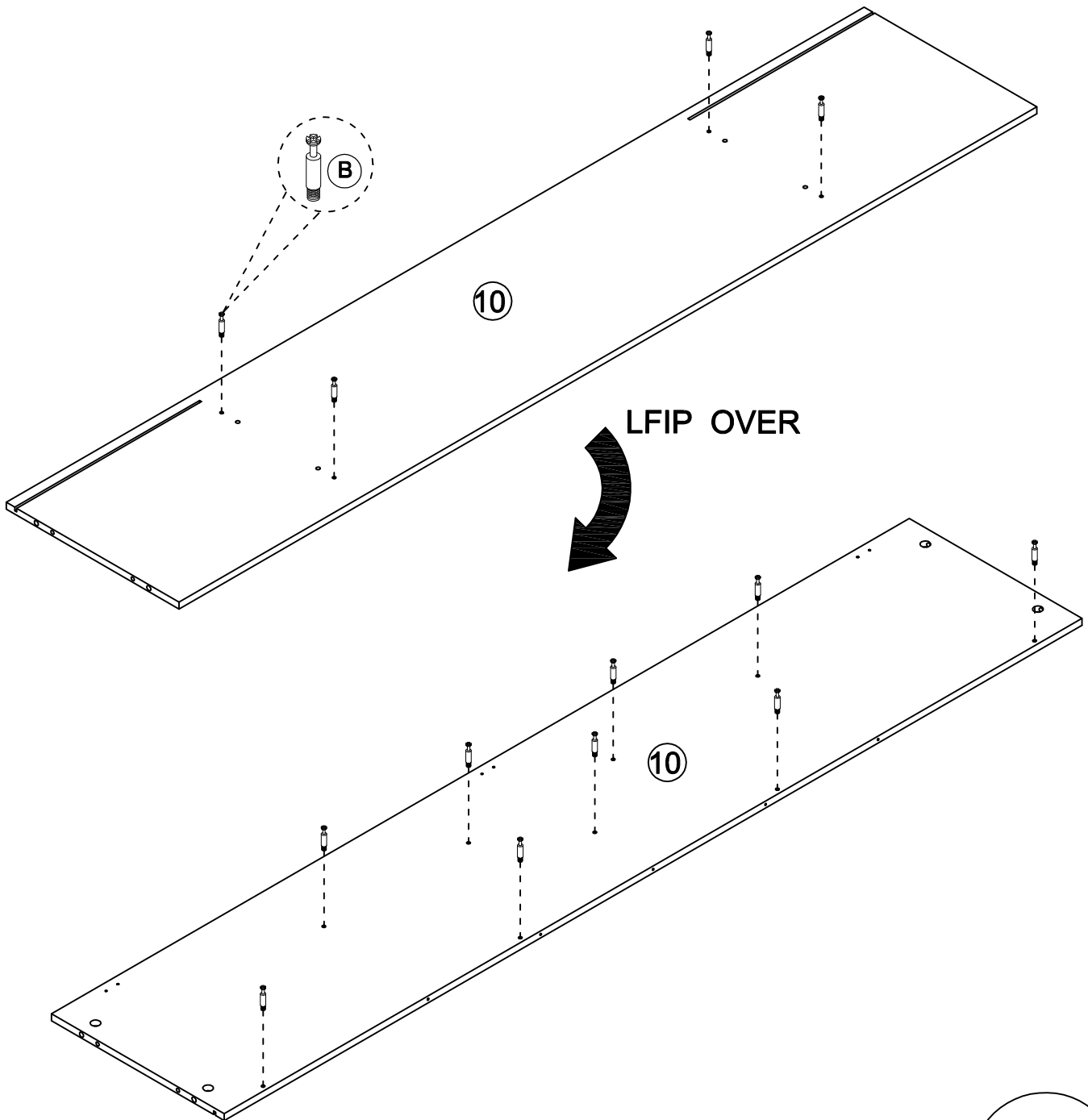
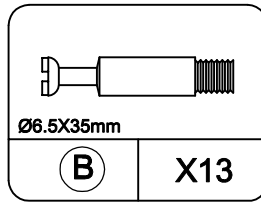
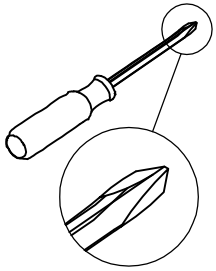

STEP 7

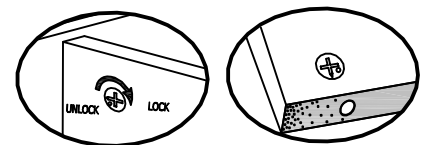
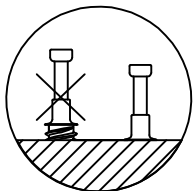
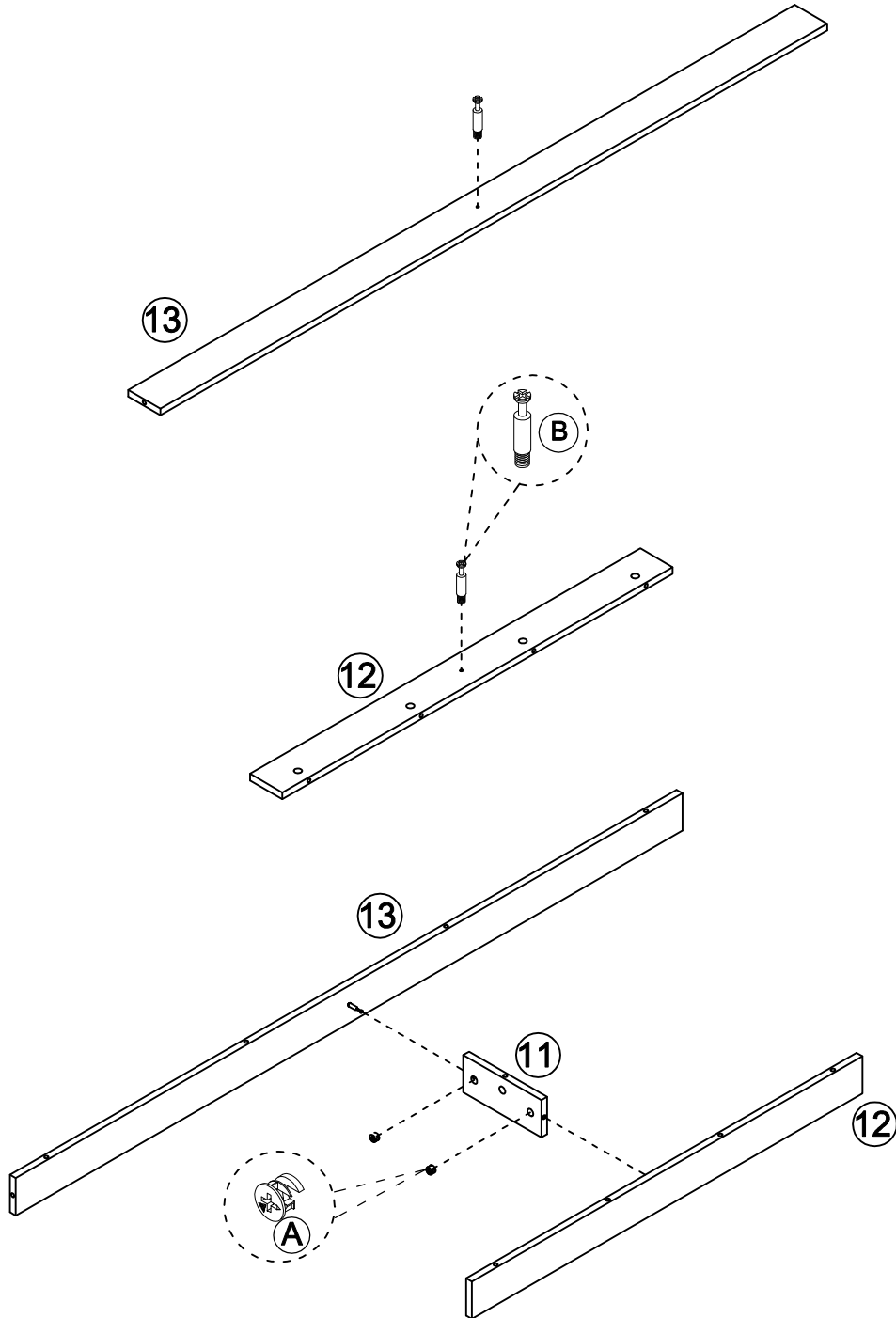
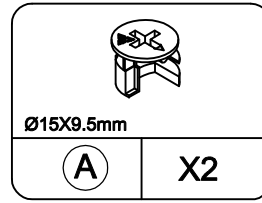
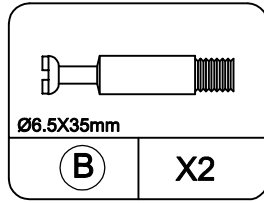
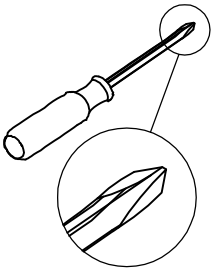

Proper orientation of CAM LOCK

STEP 8

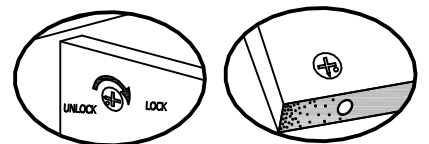
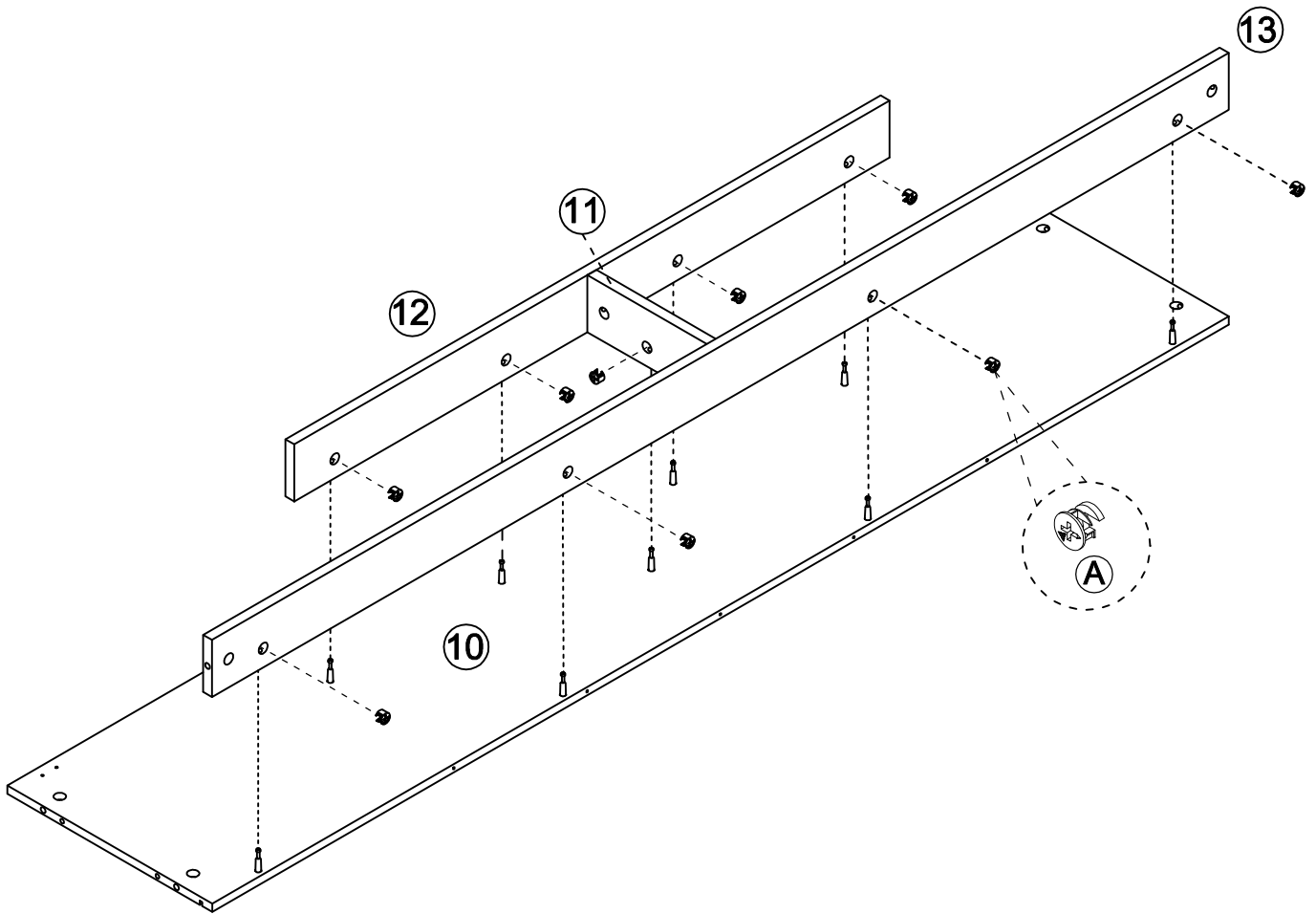
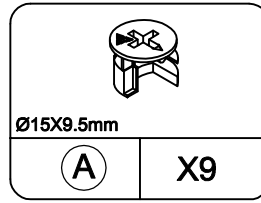
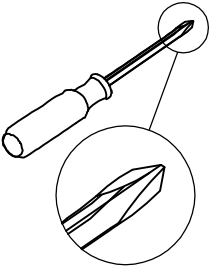

Proper orientation of CAM LOCK

STEP 9

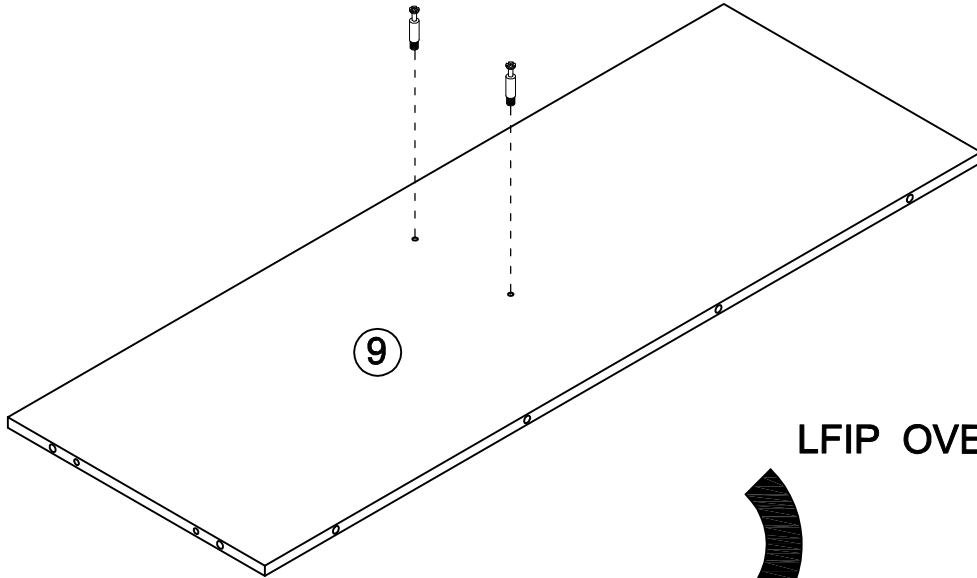
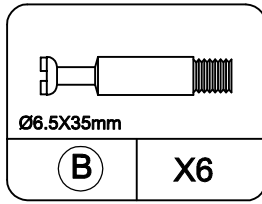
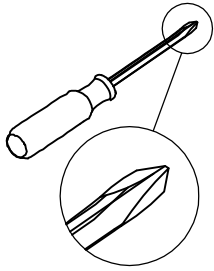

LFIP OVER

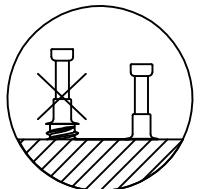
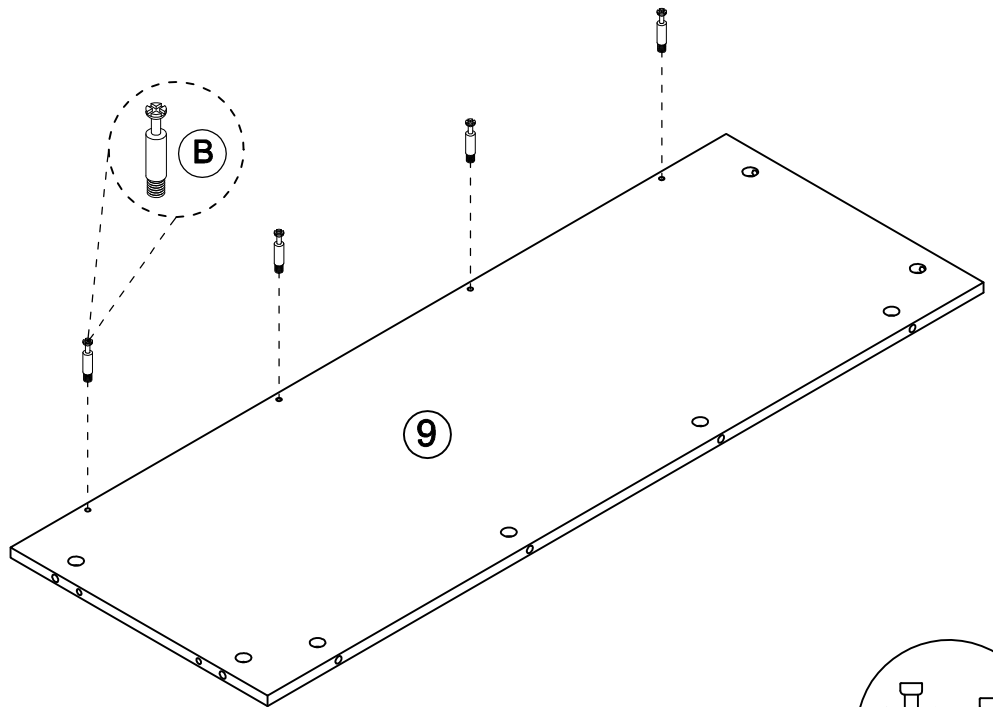

STEP 10

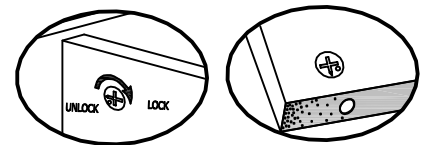
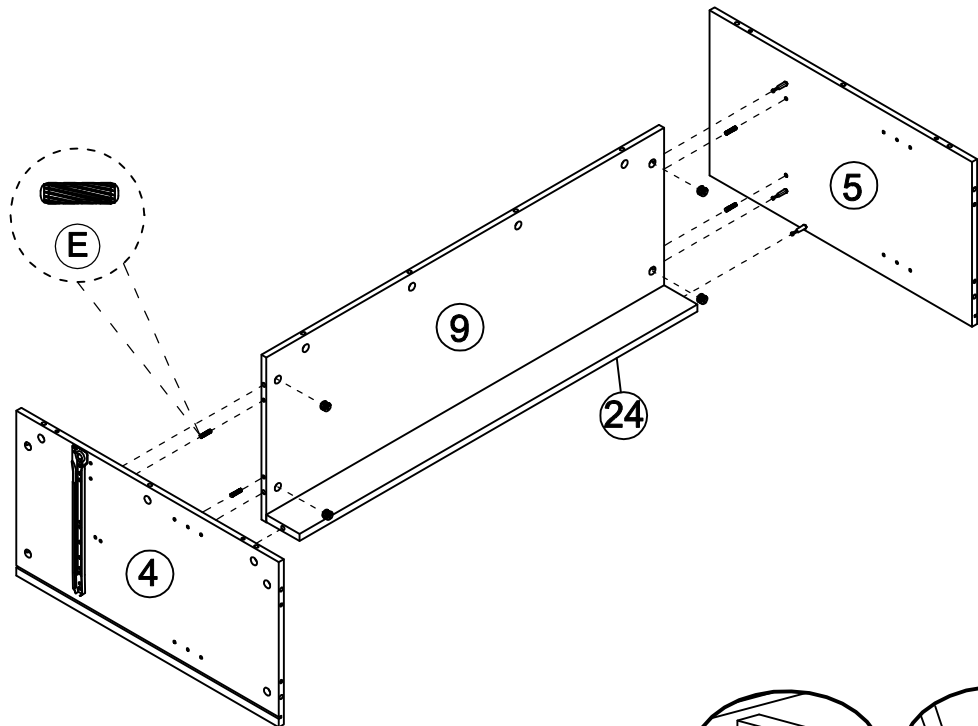
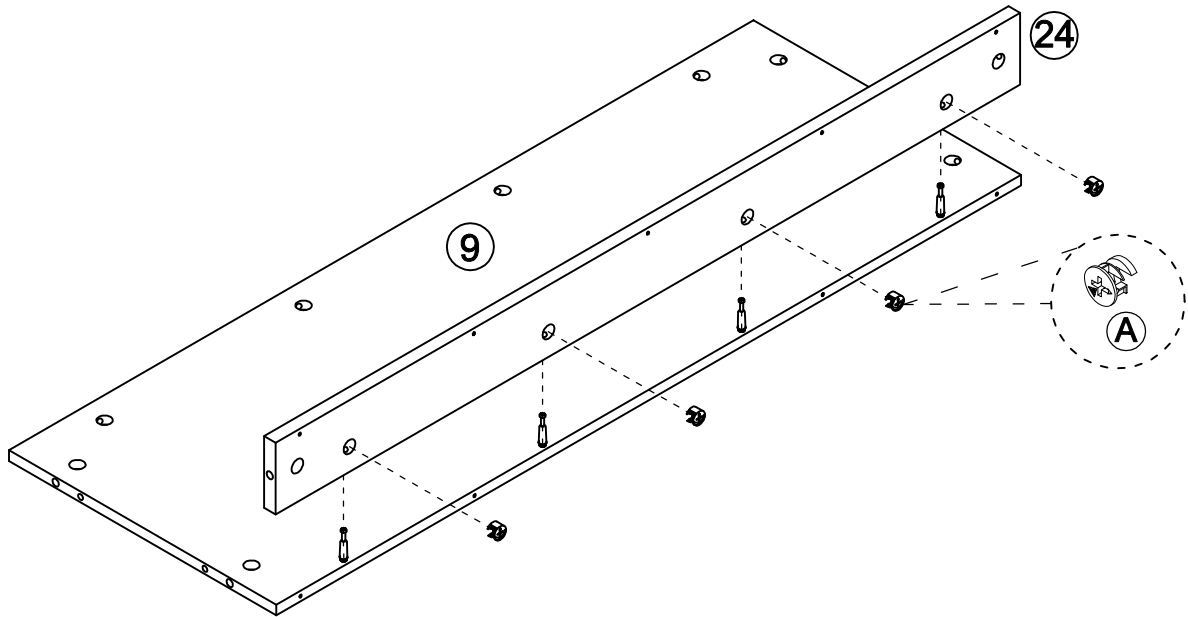
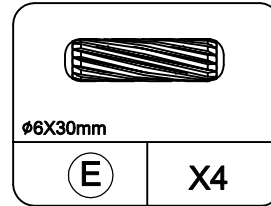
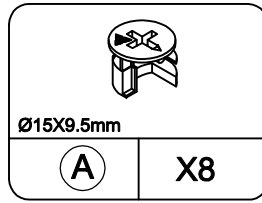
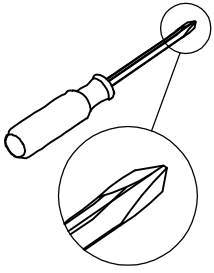

Proper orientation of CAM LOCK

STEP 11

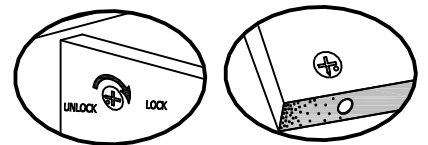
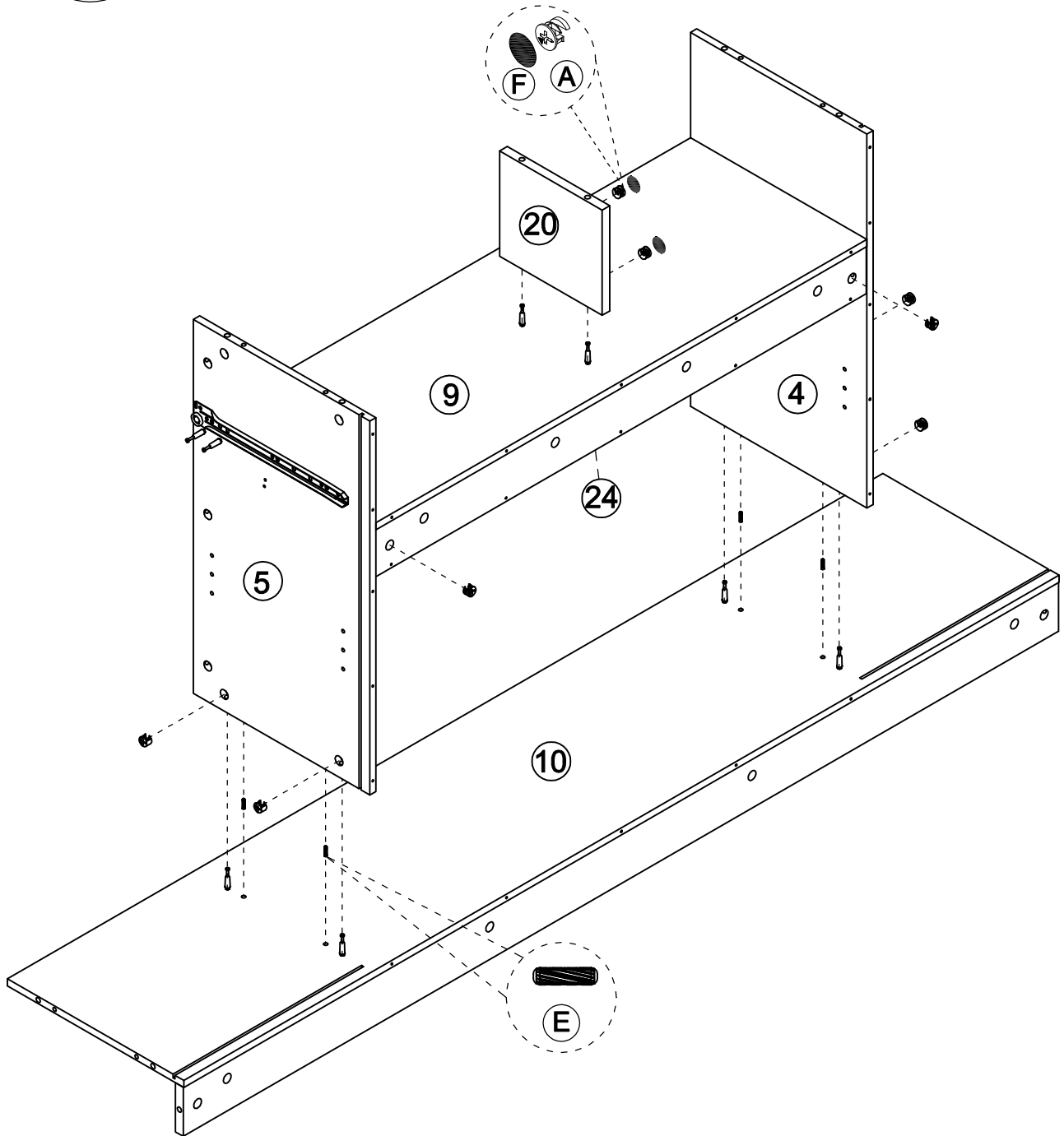
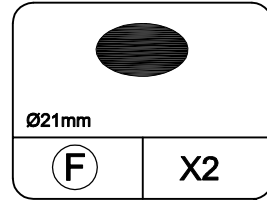
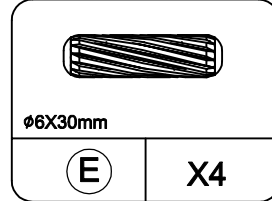
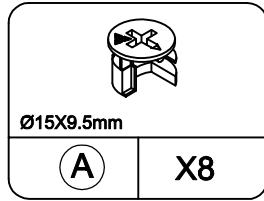
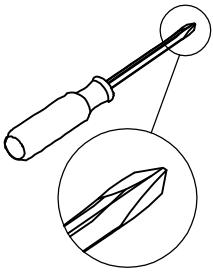

Proper orientation of CAM LOCK

STEP 13

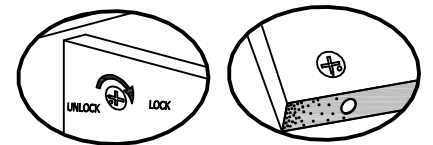
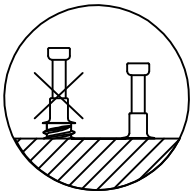
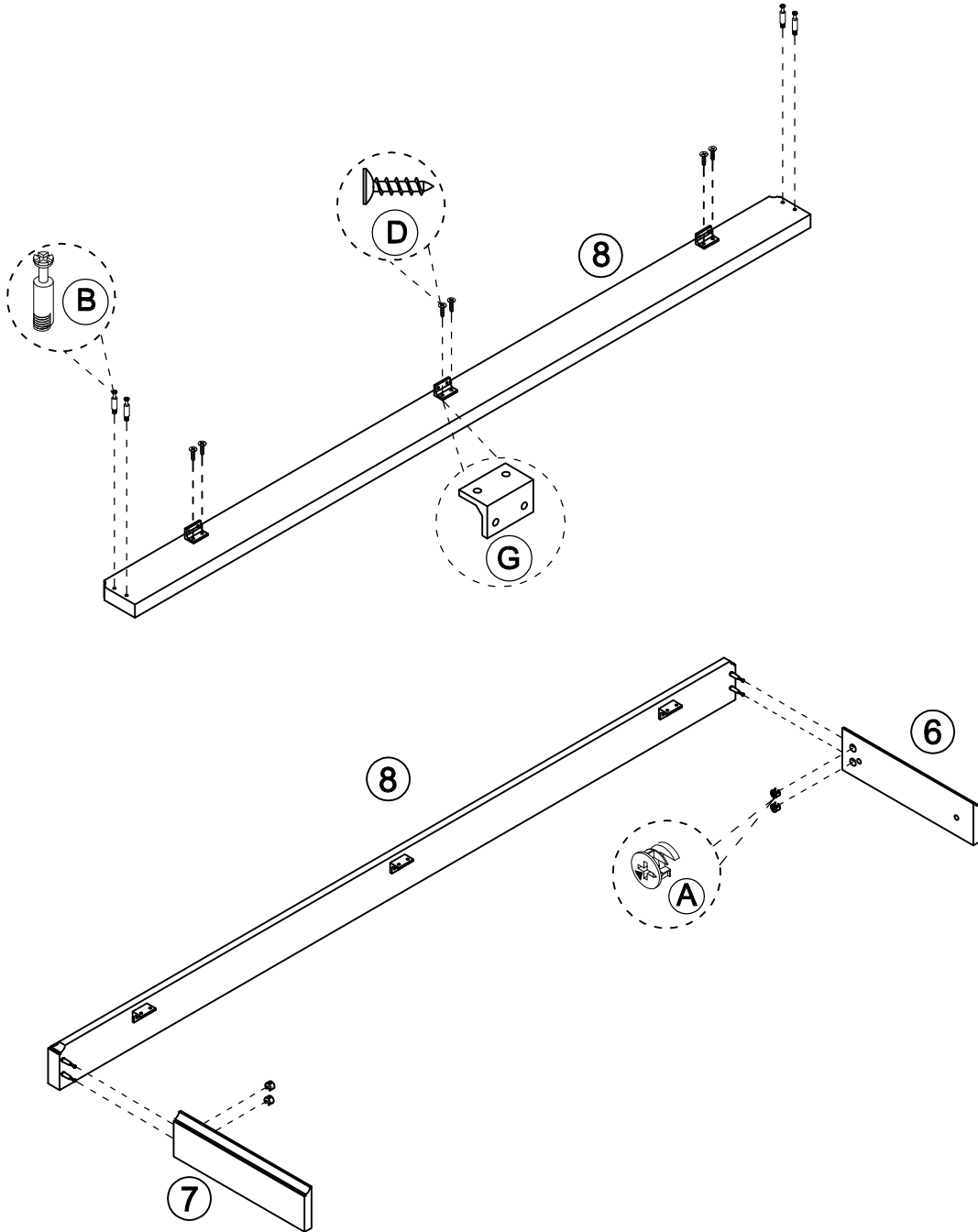
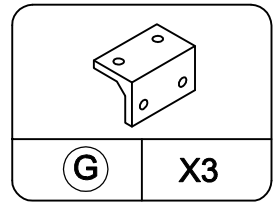
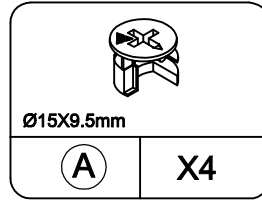
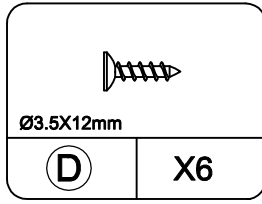
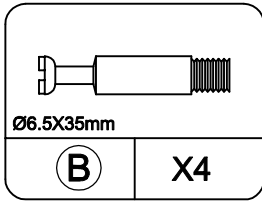
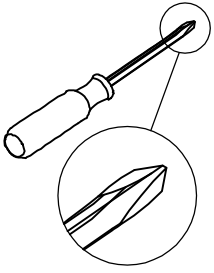

Proper orientation of CAM LOCK

STEP 14

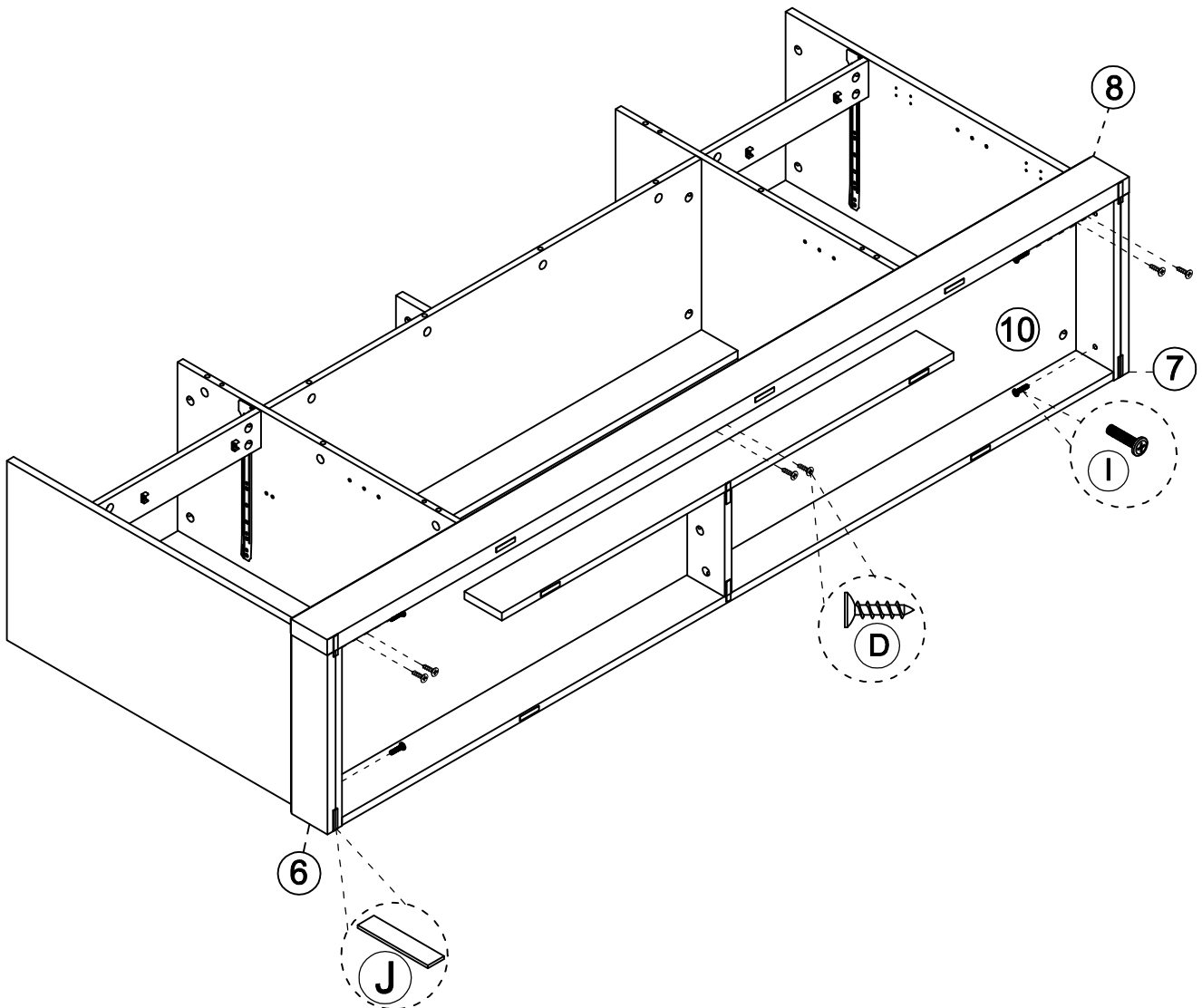
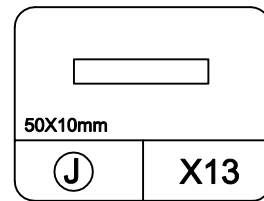
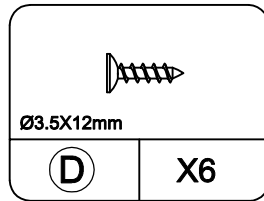
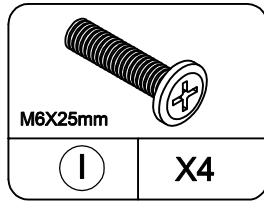
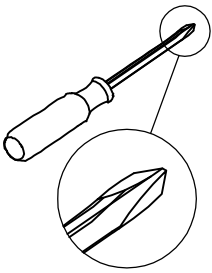

**Tear the layer off
then stick it on the
side panel**

STEP 15

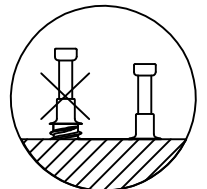
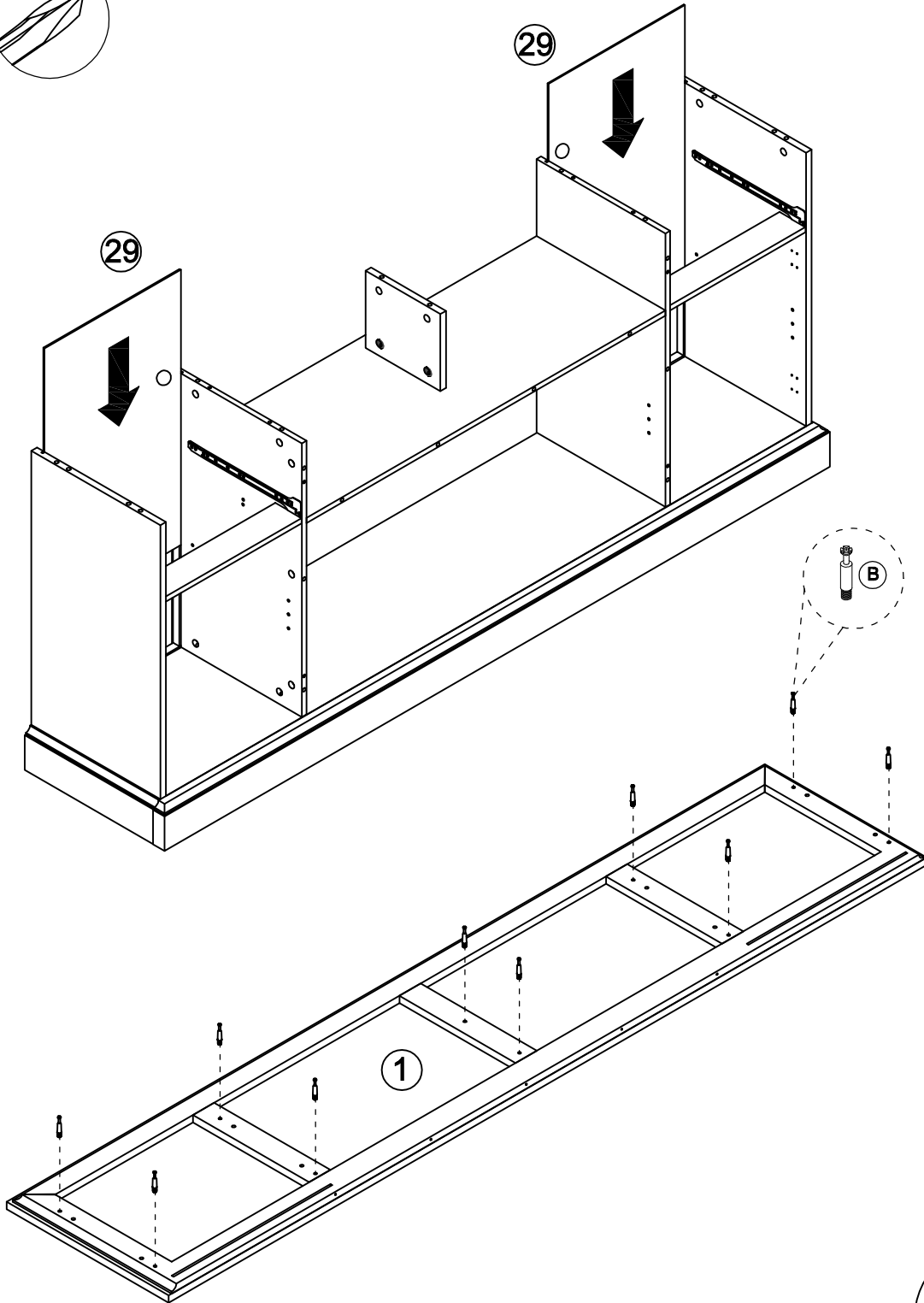
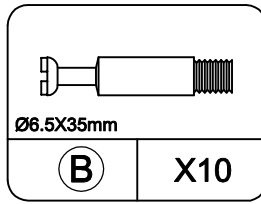
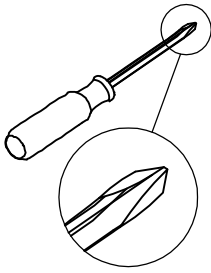

STEP 16

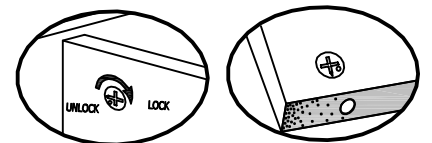
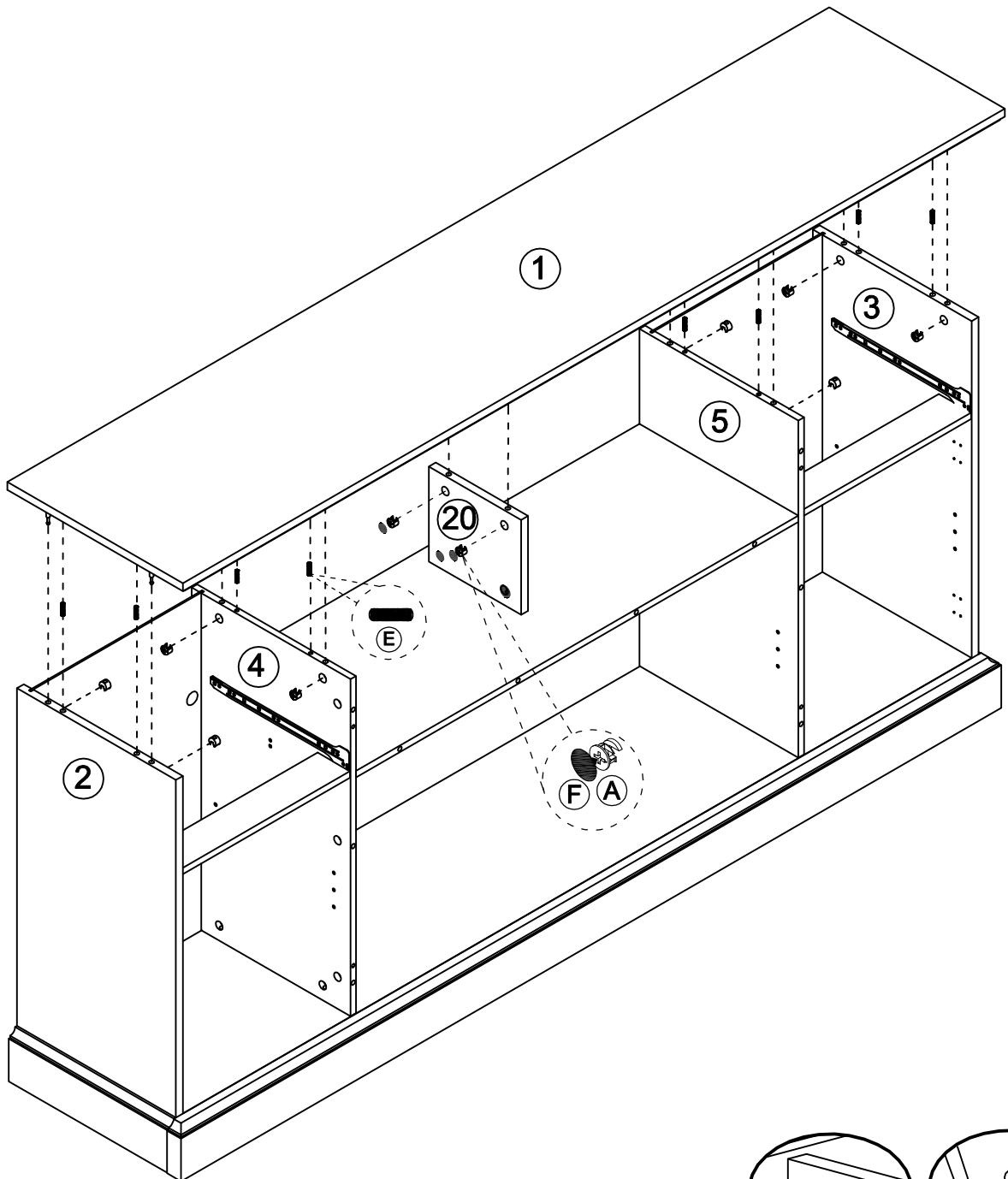
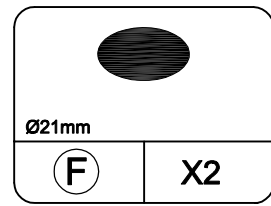
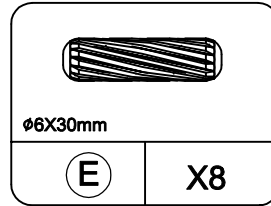
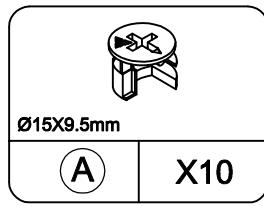
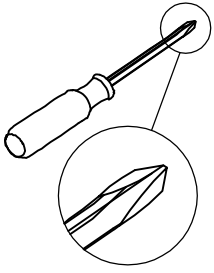

Proper orientation of CAM LOCK

STEP 17

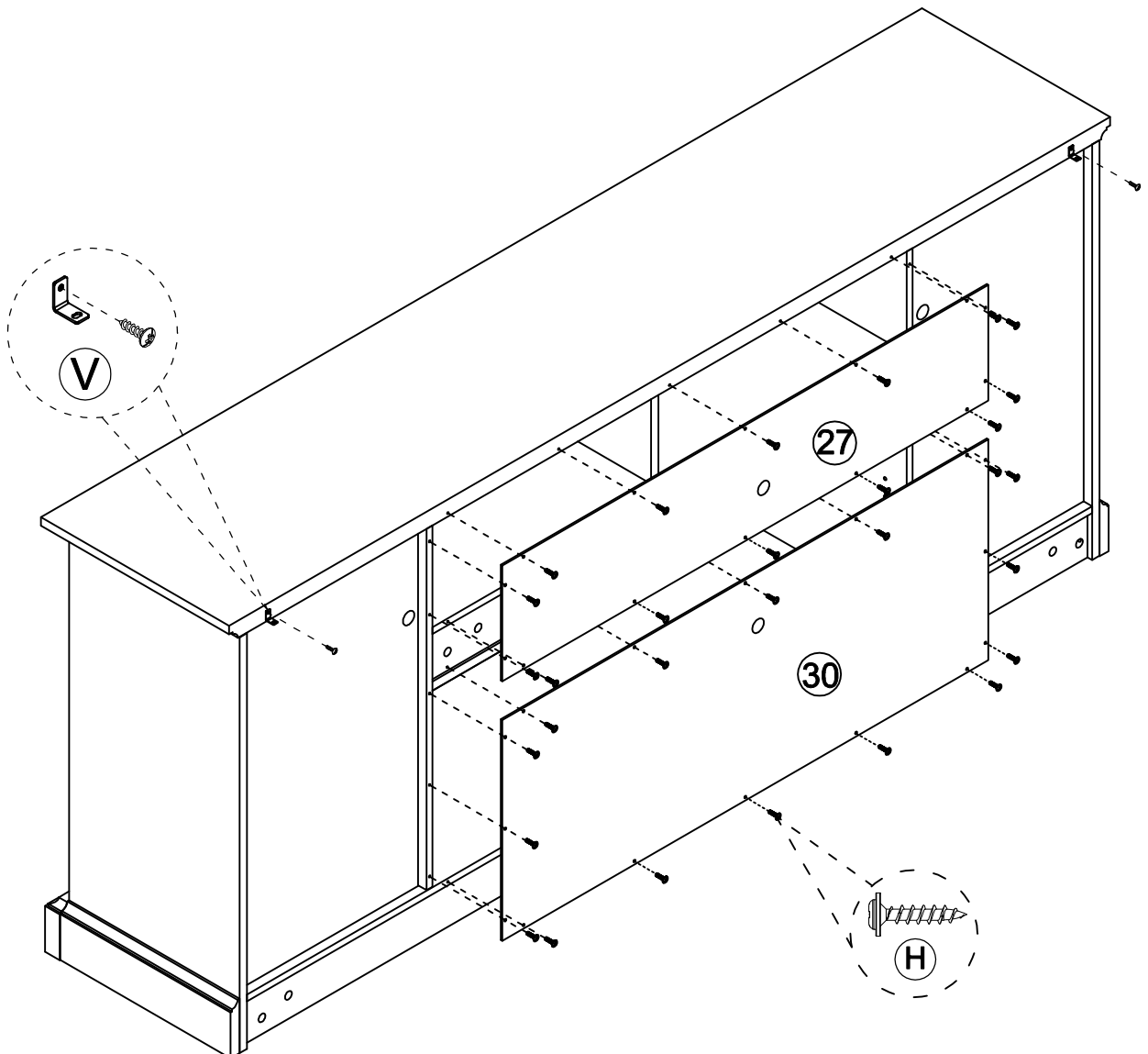
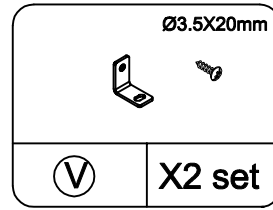
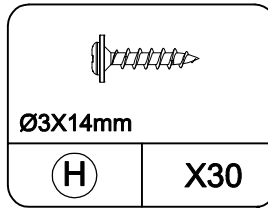
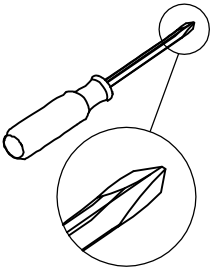

STEP 18

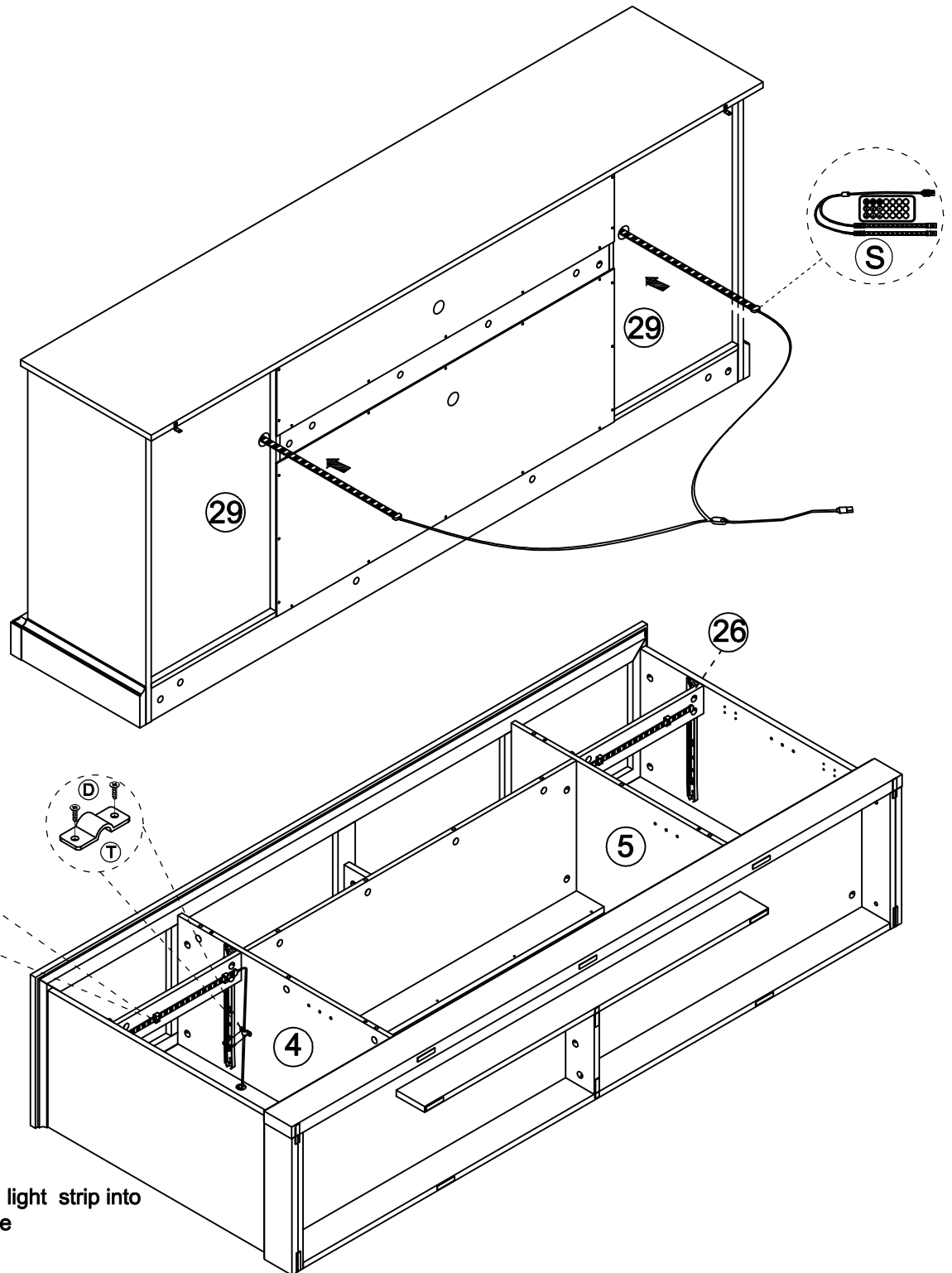
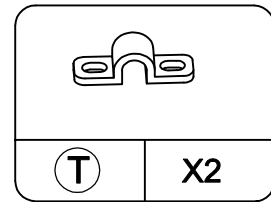
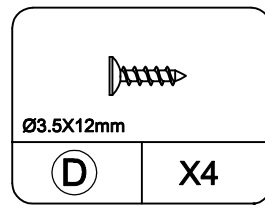
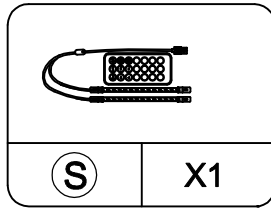
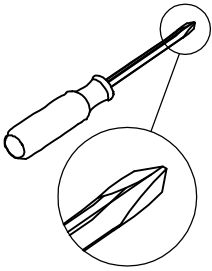

push the light strip into the buckle

STEP 19

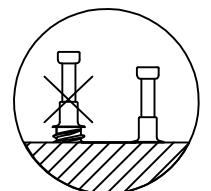
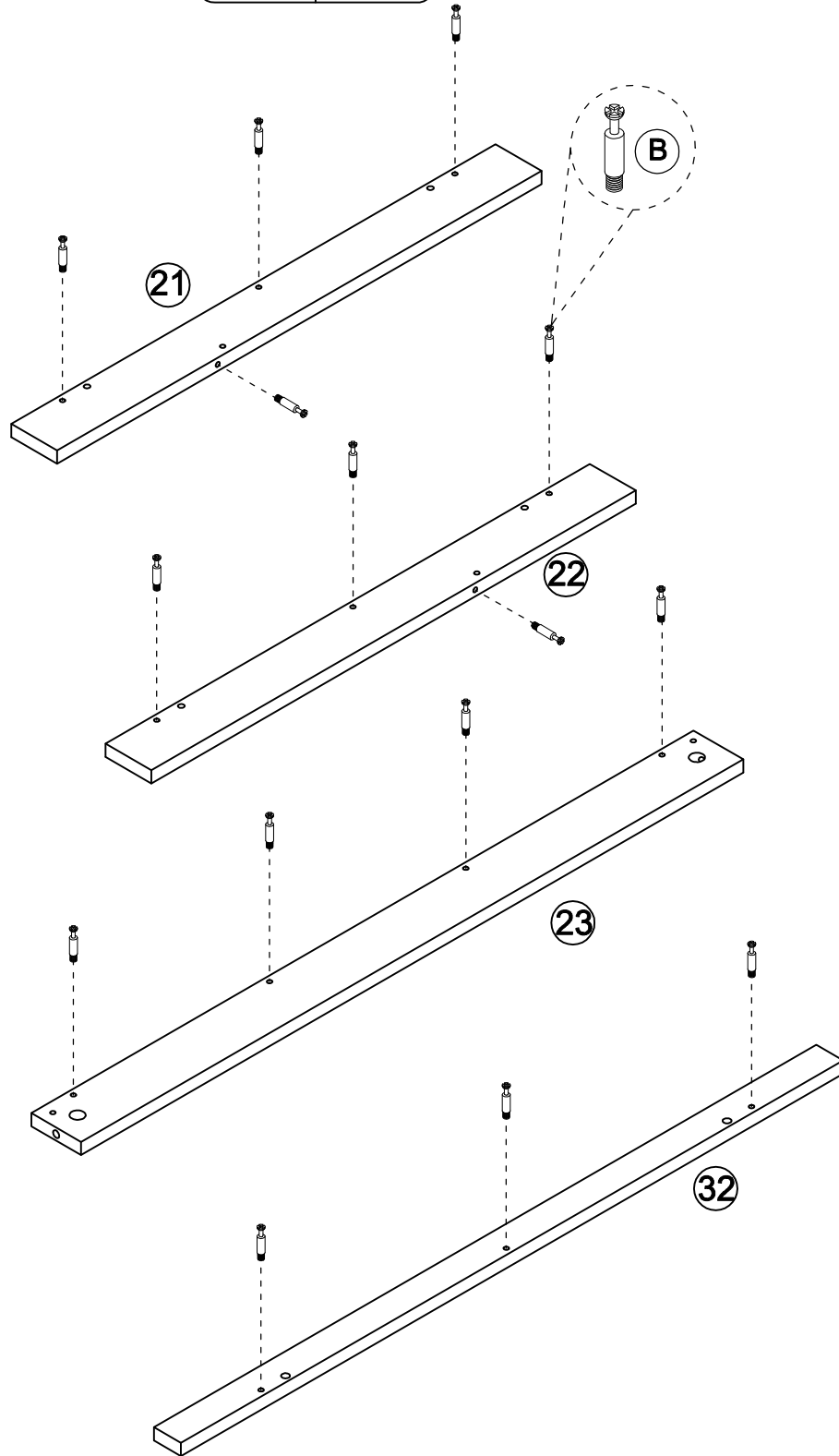
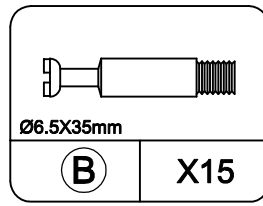
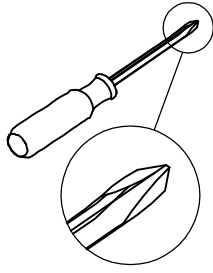

STEP 20

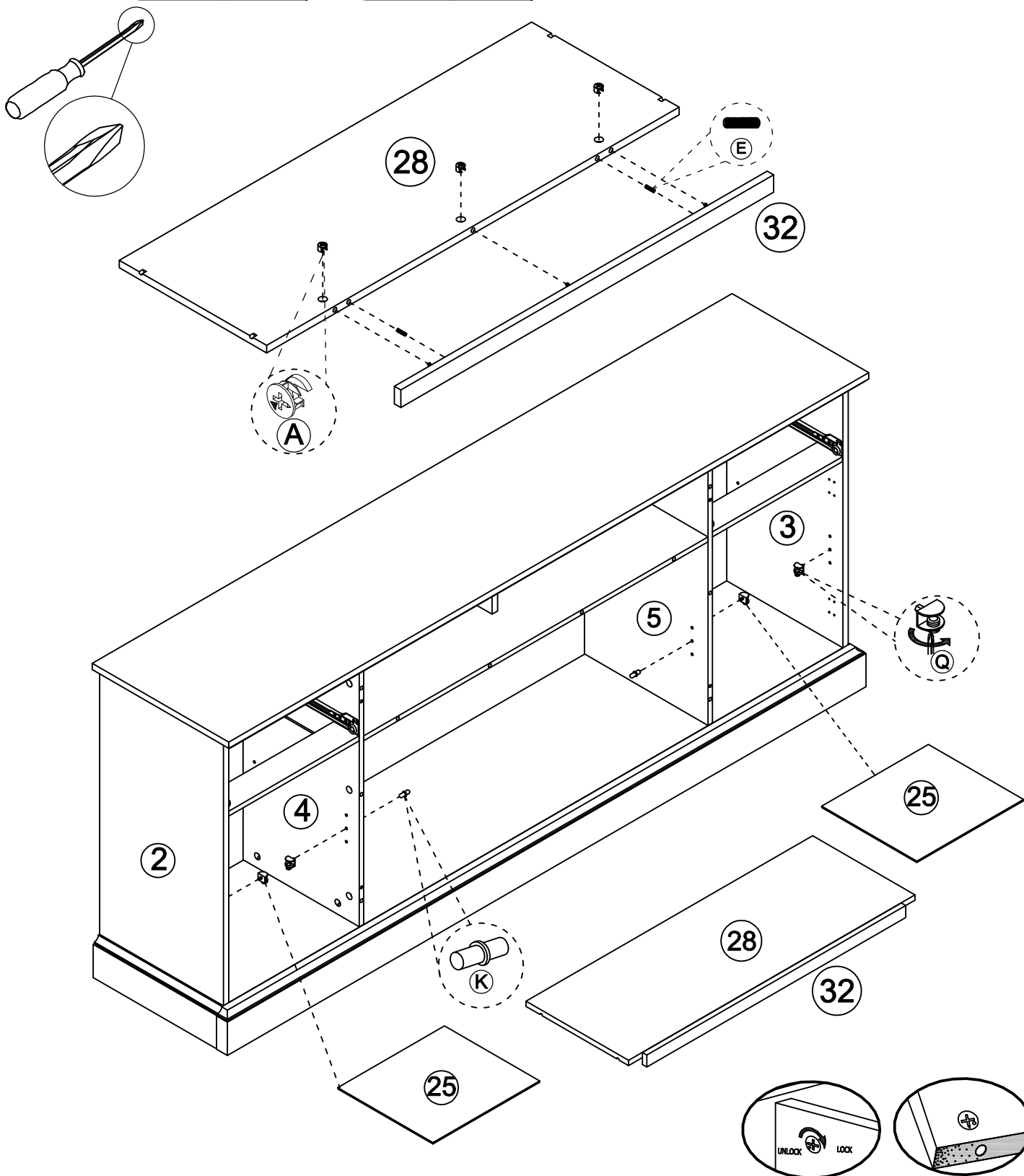
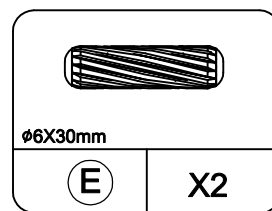
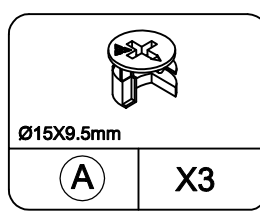
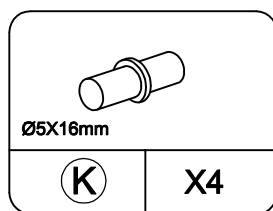
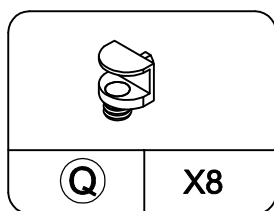

STEP 21



Ø15X9.5mm

A X12



Ø6X30mm

E X4



Ø21mm

F X4



U X2



Ø3.5X12mm

D X4

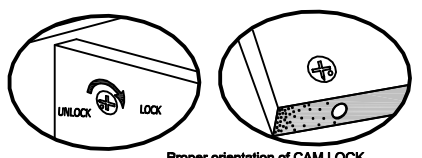
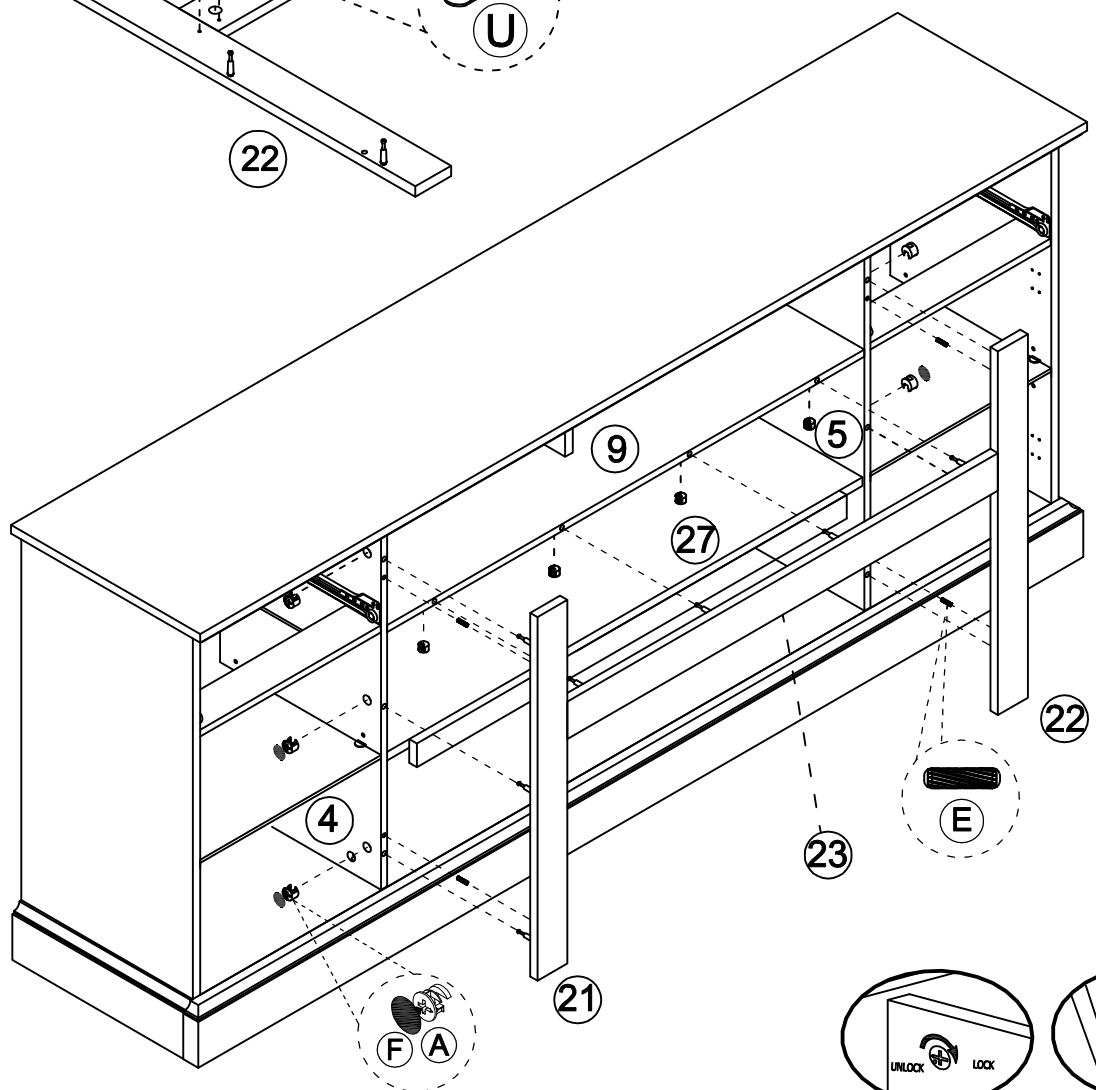
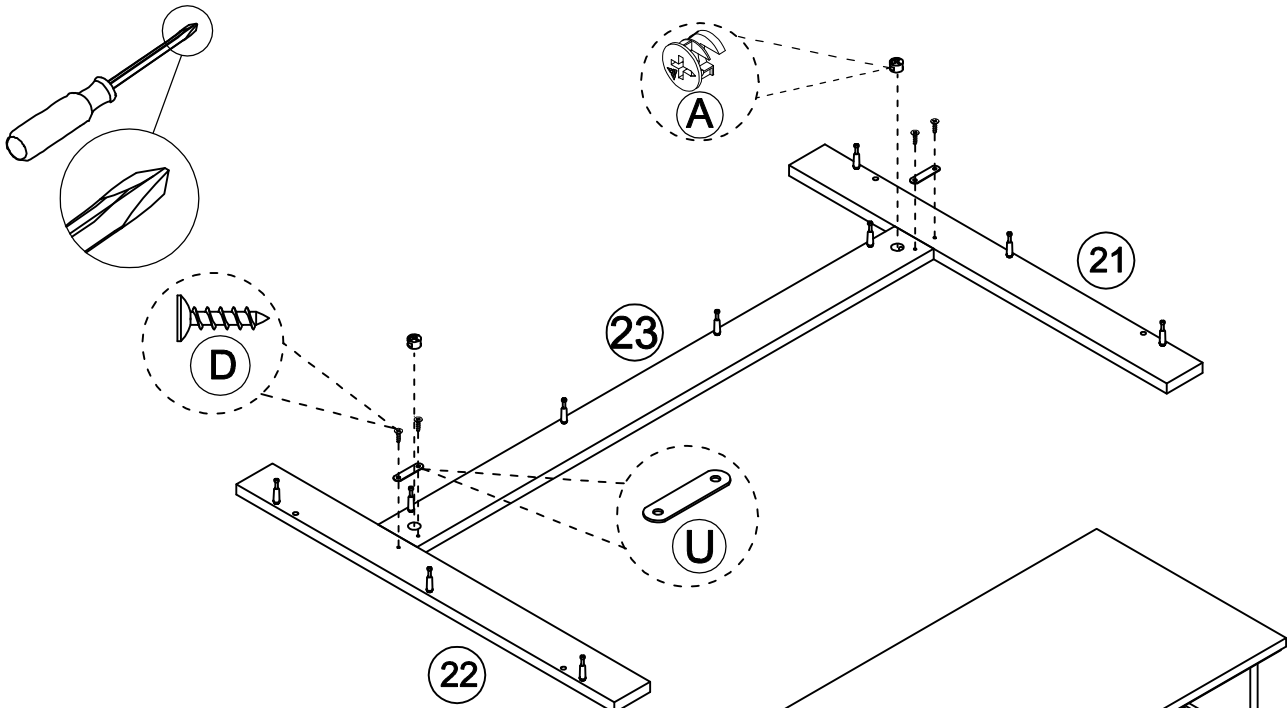

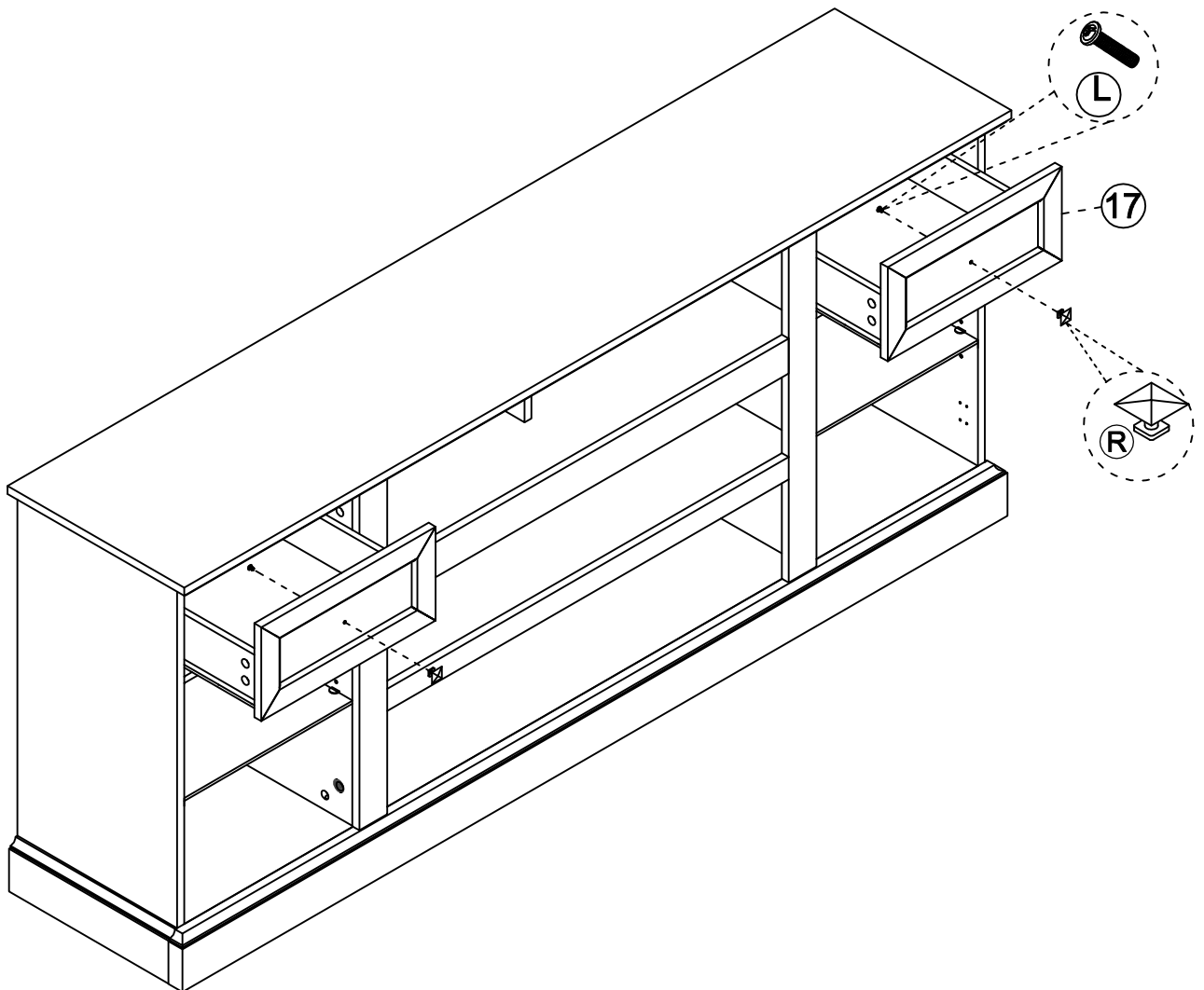
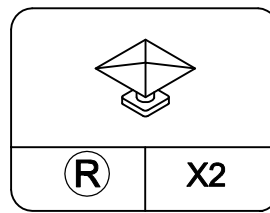
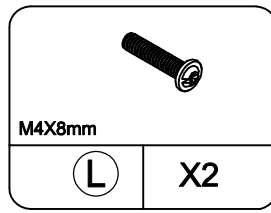
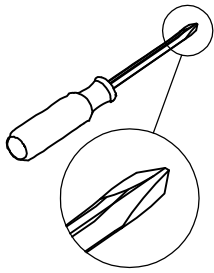

STEP 22



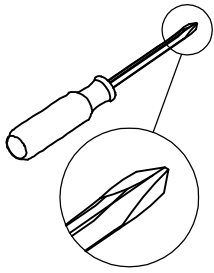

STEP 23



 Ø3.5X12mm	
D	X24

 M4X20mm	
N	X4

	
O	X2

	
P	X4

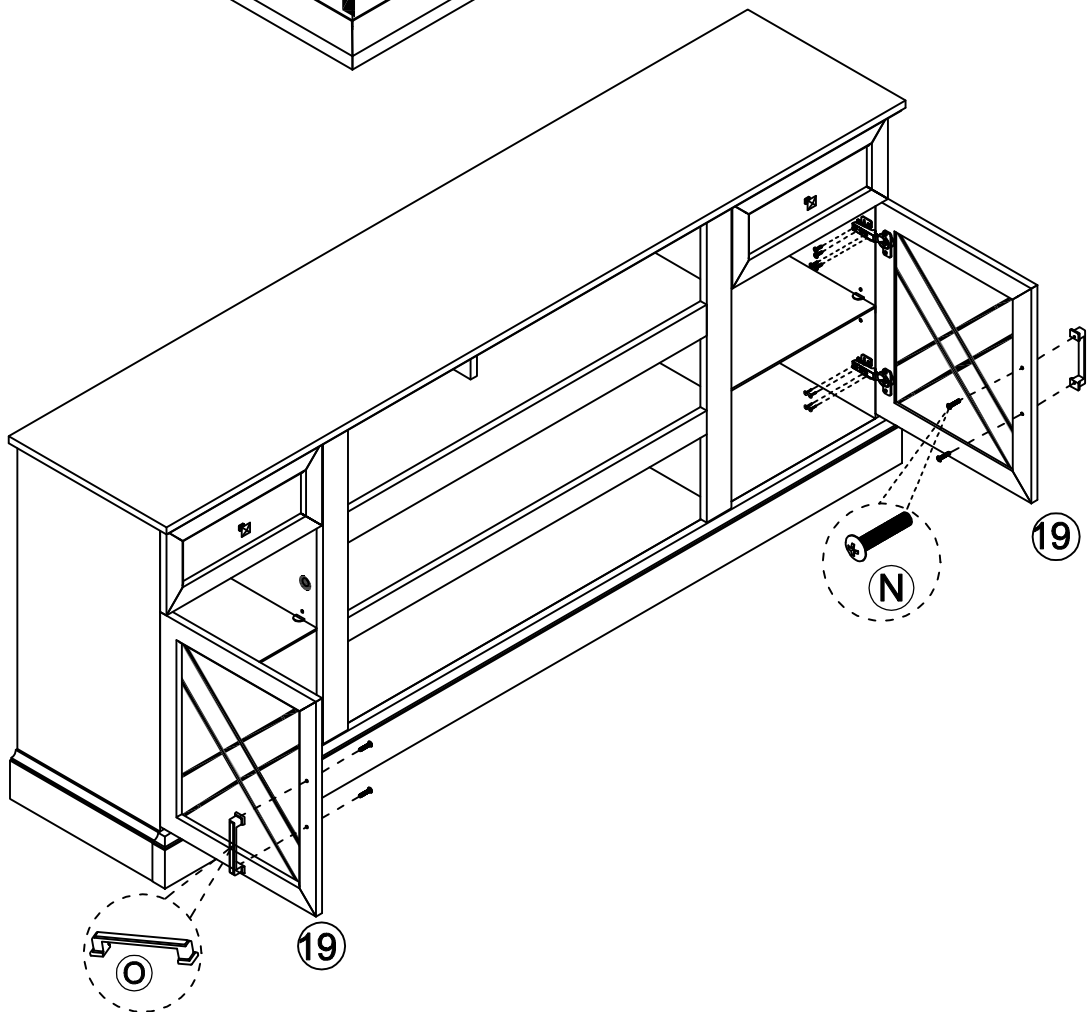
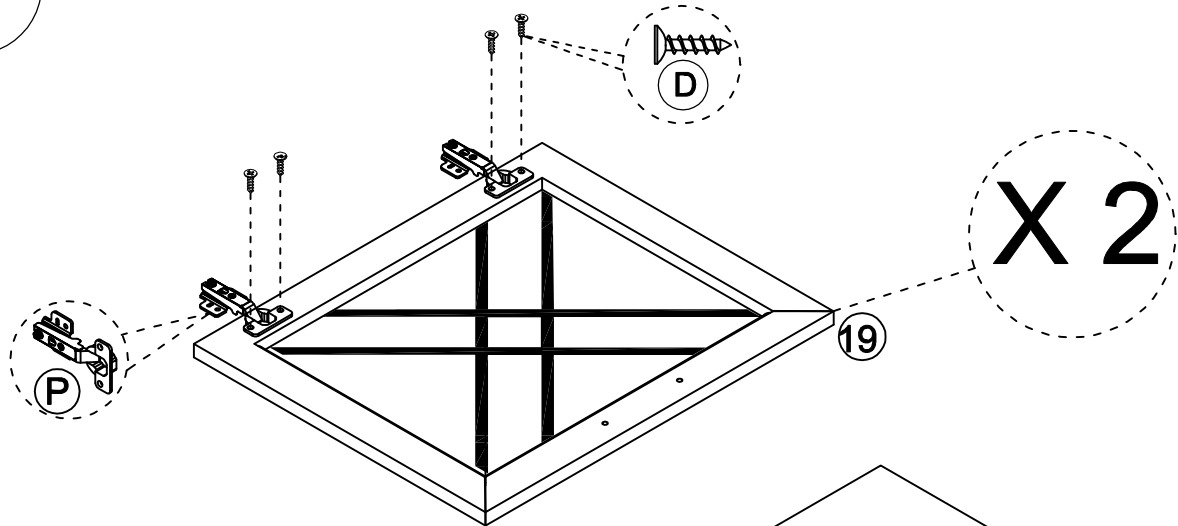

STEP 24

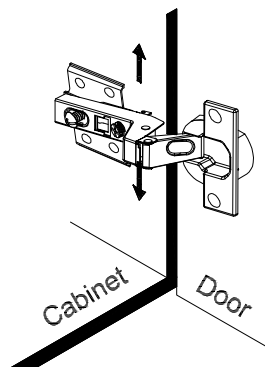
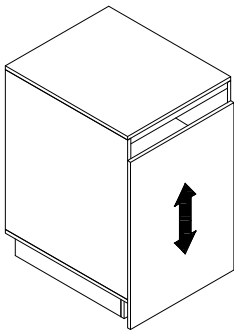
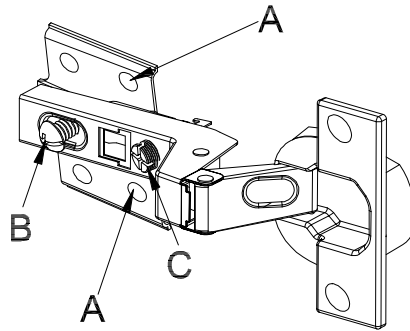

To adjust the vertical height.

Loosen the four screws "A" on both hinges. Two of them are usually in slotted holes which allows you to adjust up or down by a few mm. Then tighten them up.

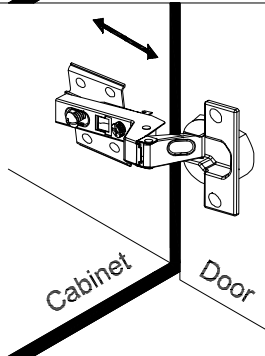
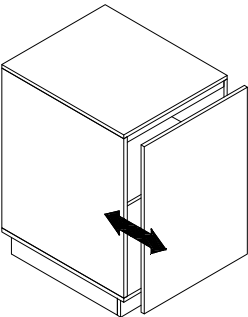

To adjust depth.



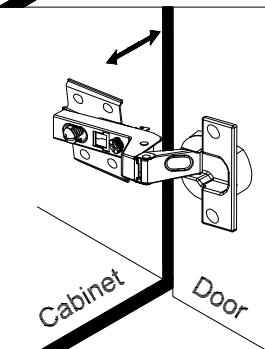
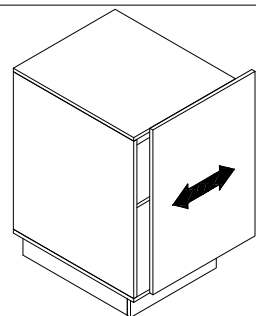

Loosen screw "B" and adjust door, if the door cannot be adjusted, please loosen screw "C", then try again. Tighten screw "B" and "C".



To adjust side ways.

Turning the screw "C" on BOTH hinges on each door.

STEP25

1PCS 	1PCS 	1PCS 	1PCS  Ø4X40mm
(R)	X2 set		

We have included a set of tipping restraint hardware for this unit. You must install this hardware to prevent accidents or injuries that can result from the unit falling. When properly installed, this restraint can provide protection against the unexpected tipping of the unit due to small tremors, bumps or climbing. We strongly recommend mounting this hardware to a wall stud and your unit.

NOTE: The tipping restraint hardware included is for wooden stud wall construction. It must be attached to a wall stud. Depending upon your wall construction different anchor hardware maybe required. Please contact your local hardware store for assistance. Young children can be seriously injured by tipping furniture. You must install the tipping restraint hardware with the unit to prevent the unit from tipping, causing any accidents or damage. The tipping restraints are intended only as a deterrent and are not a substitute for proper adult supervision. The tipping restraints are not earthquake restraints. If you wish to add the extra security of earthquake restraints, they must be purchased and installed separately.



Install the tipping restraint hardware

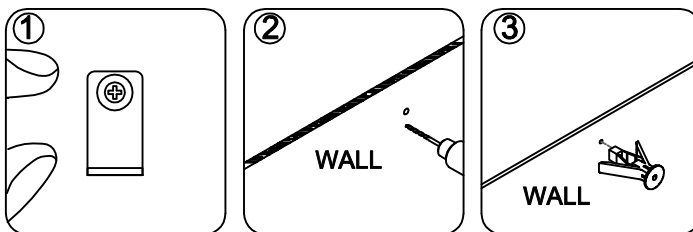

1. make mark on the wall

2. drill two Ø6 holes on the wall

3. put two anchors in the holes

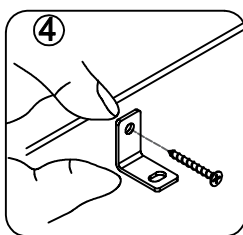

4. fix the device on the wall by the long screws

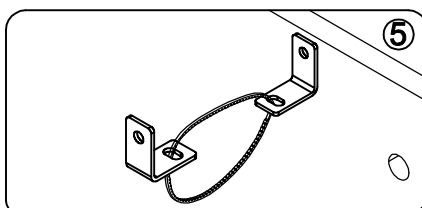

5. Push the cabinet close to the wall so that the two bases are close to each other, and then put on nylon tie to tighten it.

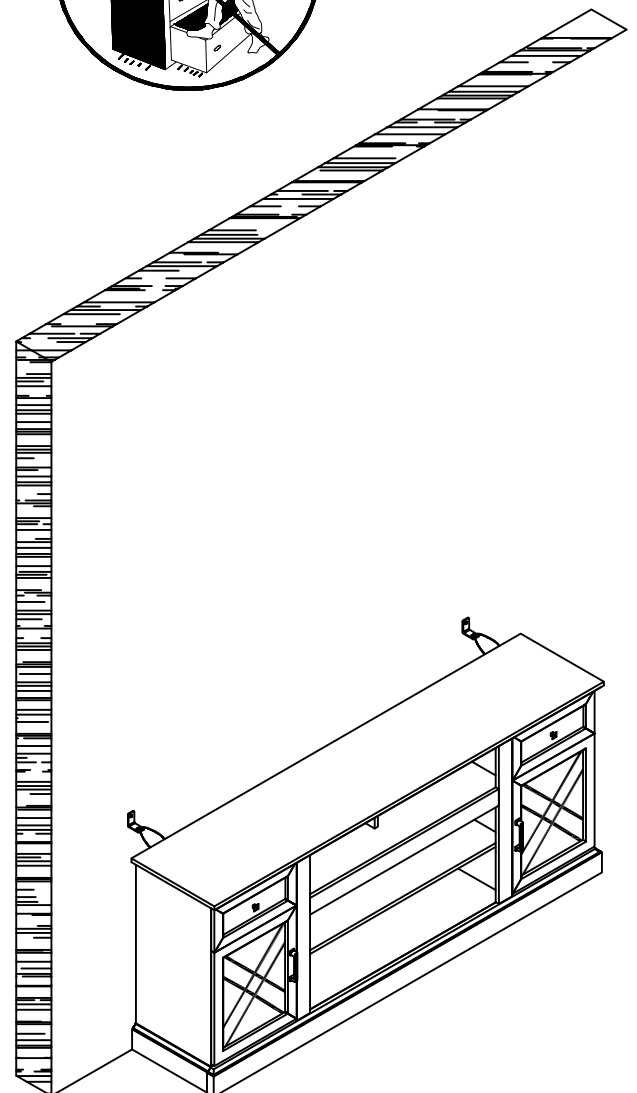

⚠ WARNING



Children have died from furniture tipover. To reduce the risk of furniture tipover:

- ALWAYS install tipover restraint provided.
- NEVER put a TV on this product.
- NEVER allow children to stand, climb or hang on drawers, doors, or shelves.
- NEVER open more than one drawer at a time.
- Place heaviest items in the lowest drawers.
- Do not defeat or remove the drawer interlock system.

This is a permanent label.

Do not remove!

⚠ ATTENTION



Des enfants sont morts du basculement des meubles. Pour réduire le risque de basculement des meubles:

- TOUJOURS installer la retenue de basculement fournie.
- NE JAMAIS mettre de téléviseur sur ce produit.
- NE JAMAIS permettre aux enfants de se tenir debout, de grimper ou de s'accrocher à des tiroirs, des portes ou des étagères.
- N'ouvrez JAMAIS plus d'un tiroir à la fois.
- Placez les objets les plus lourds dans les tiroirs les plus bas.
- Ne désactivez pas et ne retirez pas le système de verrouillage du tiroir.

Ceci est une étiquette permanente.

Ne pas enlever!

⚠ WARNUNG



Kinder sind an einem Möbelkipp gestorben. So verringern Sie das Risiko eines Umkippens von Möbeln:

- Installieren Sie IMMER die mitgelieferte Kipprückhaltevorrichtung.
- Stellen Sie NIEMALS einen Fernseher an dieses Produkt.
- Lassen Sie Kinder NIEMALS an Schubladen, Türen oder Regalen stehen klettern oder hängen.
- Öffnen Sie NIEMALS mehr als eine Schublade gleichzeitig.
- Legen Sie schwerste Gegenstände in die untersten Schubladen.
- Besiegen oder entfernen Sie das Schubladenverriegelungssystem nicht.

Dies ist ein dauerhaftes Etikett.

Nicht entfernen!