

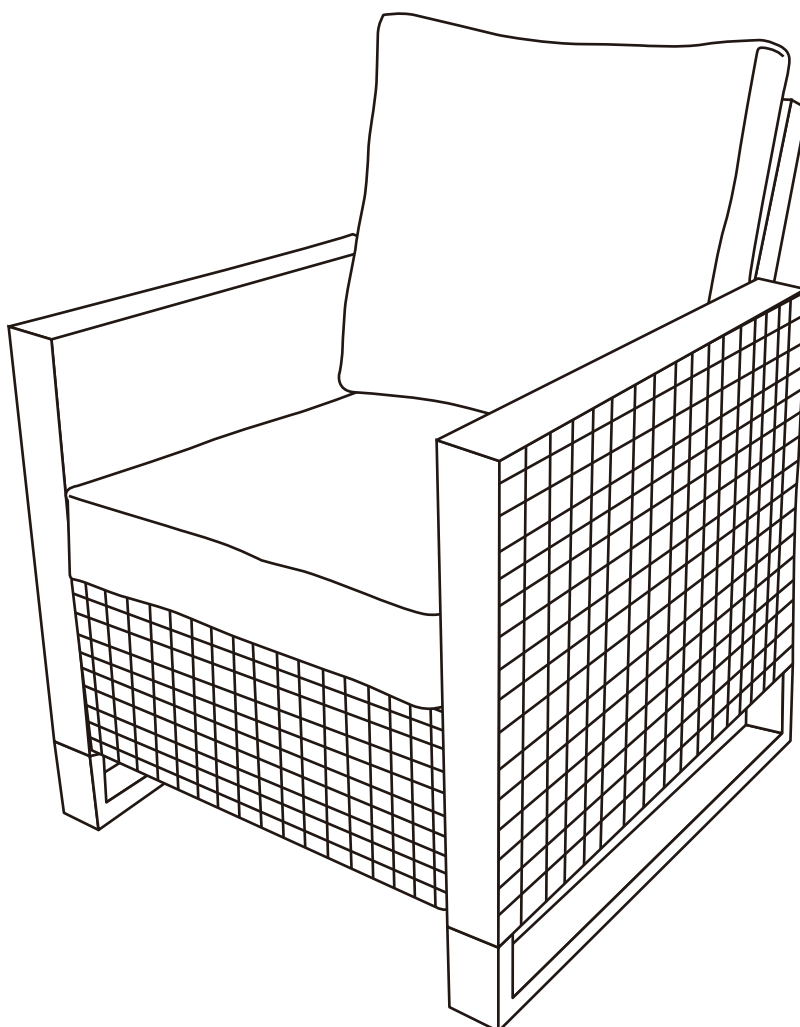







ASSEMBLY INSTRUCTION

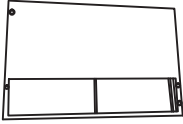
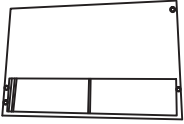

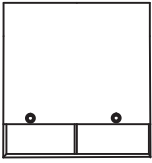
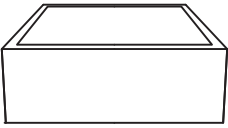
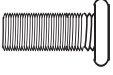
* Don't fully tighten all the bolts till the very end!

PRE-ASSEMBLY PREPARATION:

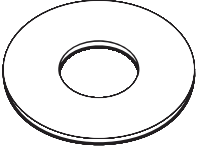
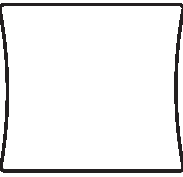
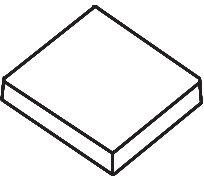
- Please read through the instructions before beginning assembly.
- Clear out the space for assembly and lay out all of the parts based on the Parts List, extra room will allow you to easily determine if all the pieces are present.
- Keep small parts and pieces away from children until fully assembled.

| Part No. | Part | Qty | Image | Part No. | Part | Qty | Image |
|----------|--------------|-----|--|----------|--------------|-----|---|
| A1 | Left Arm | 1 |  | A2 | Right Arm | 1 |  |
| B | Feet | 2 |  | C | Back | 1 |  |
| D | Seat | 1 |  | E | Bolt | 8 |  M6 * 20MM |
| F | Bolt | 6 |  M6 * 35MM | G | Bolt | 2 |  M6 * 40 MM |
| H | Bolt | 2 |  M6 * 95MM | I | Washer | 18 |  |
| J | Back Cushion | 1 |  | K | Seat cushion | 1 |  |
| L | Wrench | 1 |  | | | | |

STEP 1

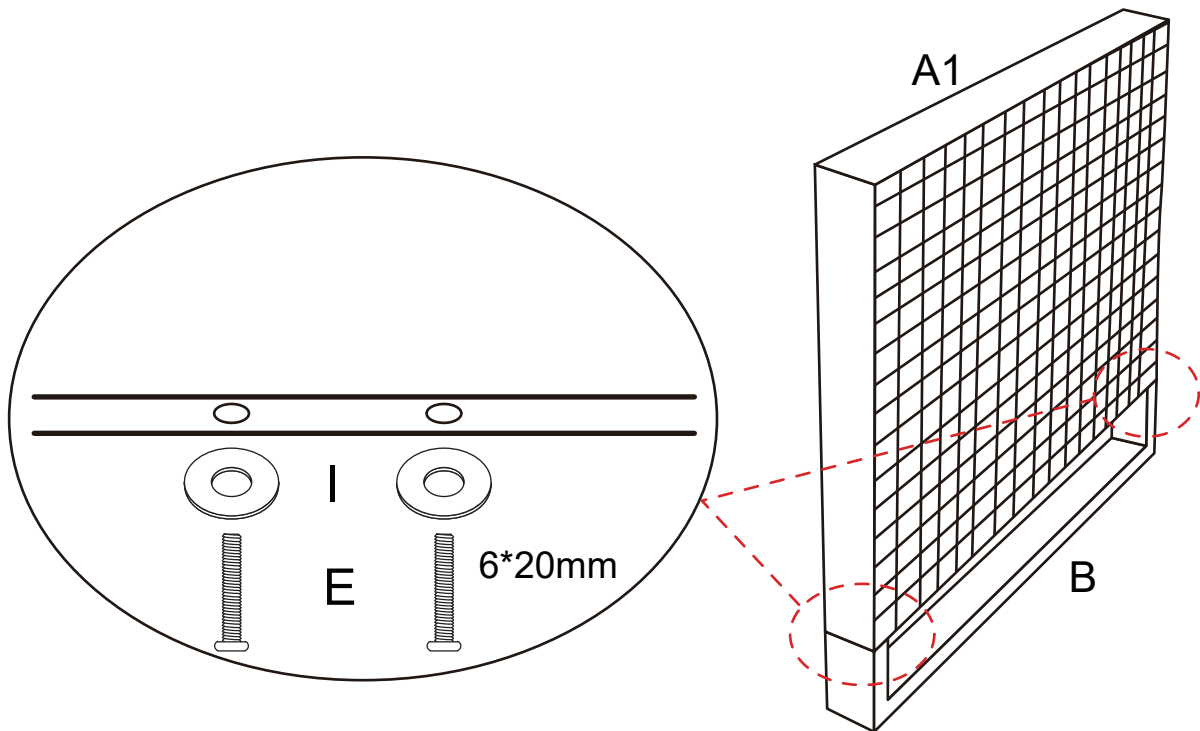

Attach left arm and feet with E and I. Don't tighten bolts!
Attach right arm and feet in the same way.

STEP 2

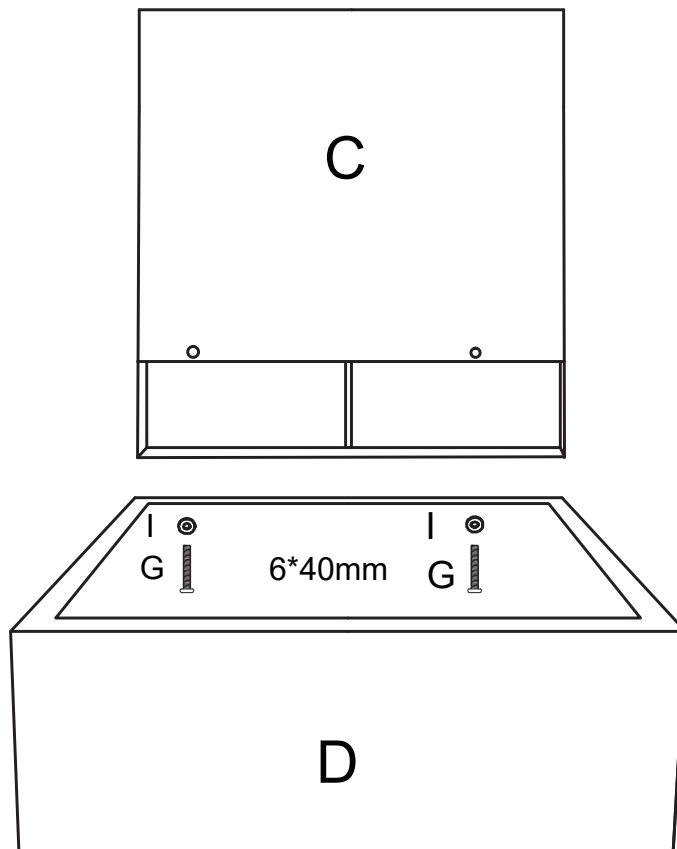

Attach seat and back with G and I. Don't tighten bolts!

STEP 3

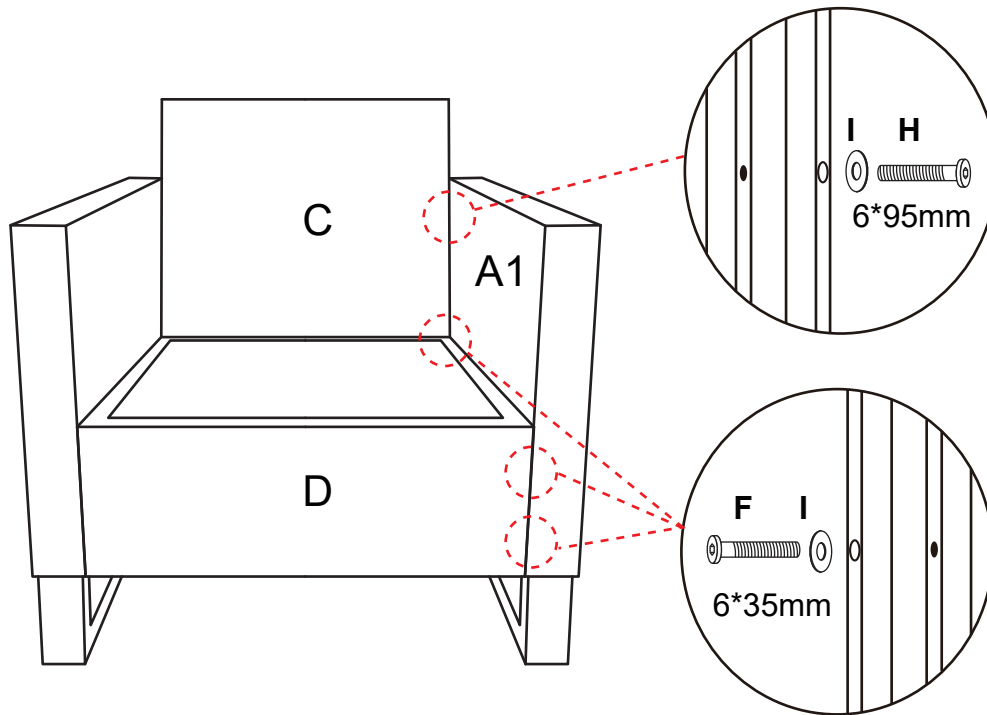

Attach left arm and back with H and I. Don't tighten bolts!

Attach left arm, back and seat with F and I. Don't tighten bolts!

Attach right arm in the same way. Tighten all the bolts!

STEP 4

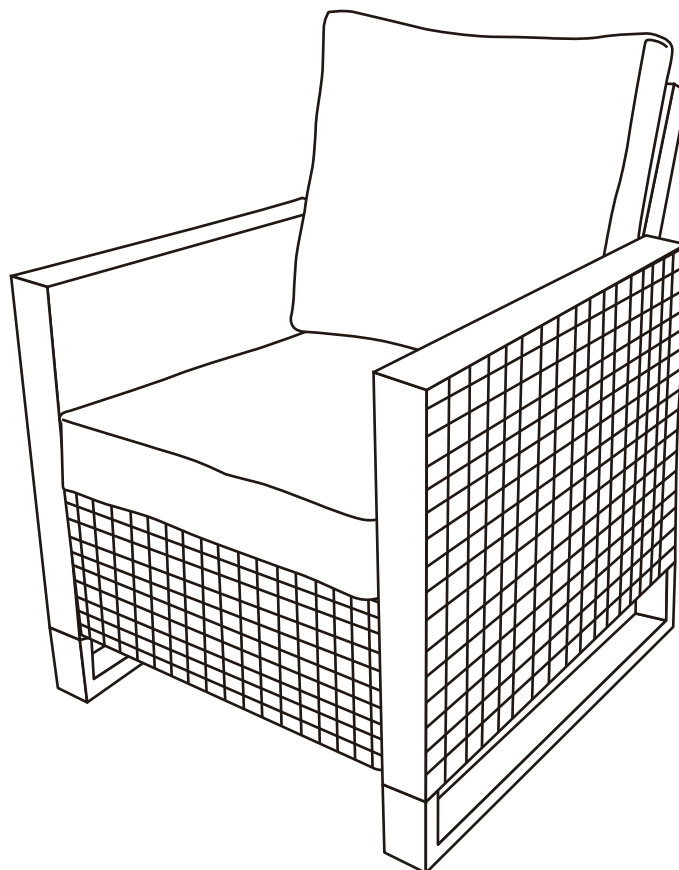

Put seat and back cushions on the chair.