

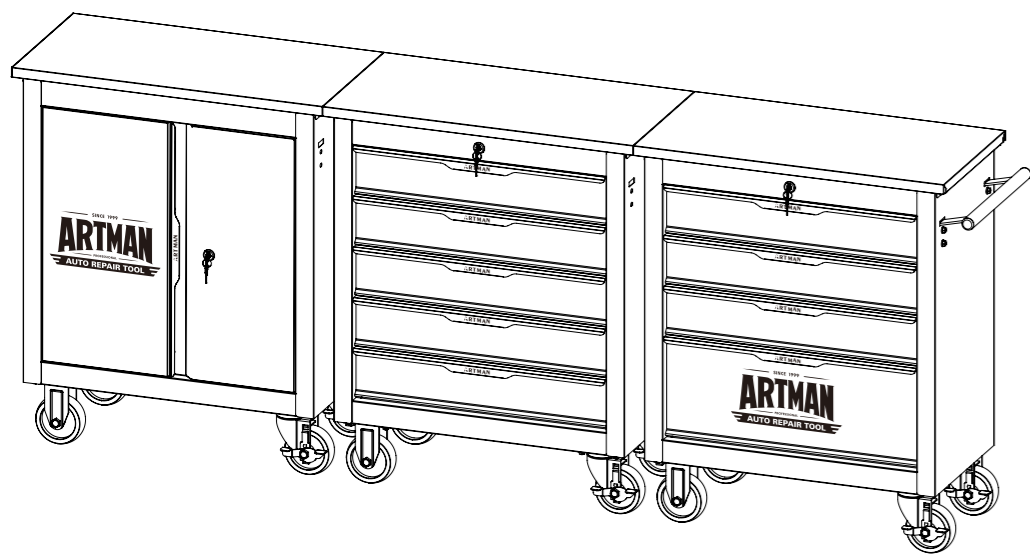

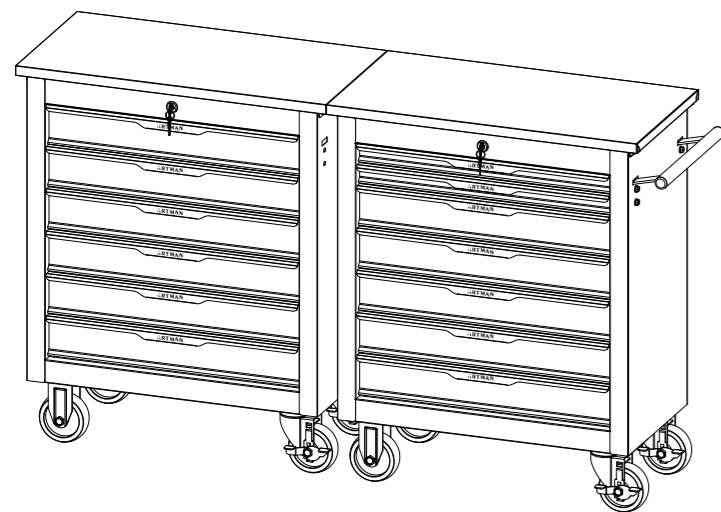





ARTMAN

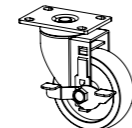
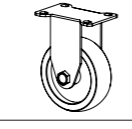
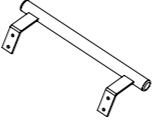

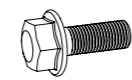
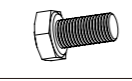
		
TEIL	NR.	STK.
BODY	1	1 PCS
	2	2 PCS
	3	2 PCS
	4	1 PCS
	5	2 PCS
 M6*12	6	4 PCS
 M6*16	7	16 PCS
 M6	8	16 PCS
 M6	9	16 PCS
 M6*12	10	4 PCS
	11	2 PCS

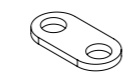