

		30'
		1

F

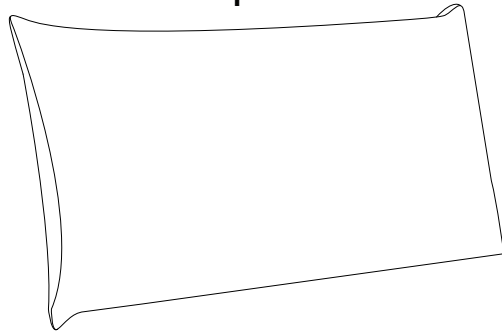

B

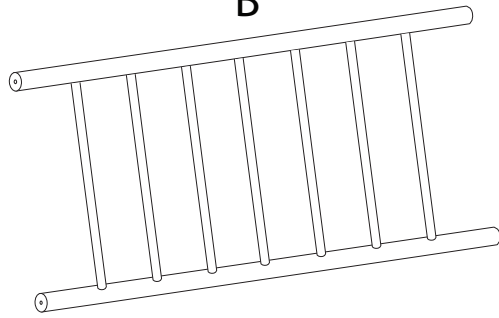

E

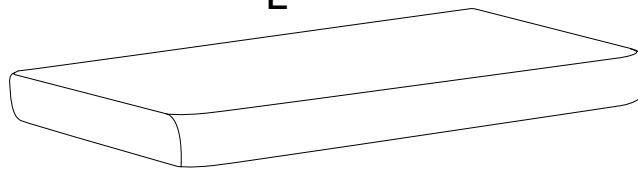

C

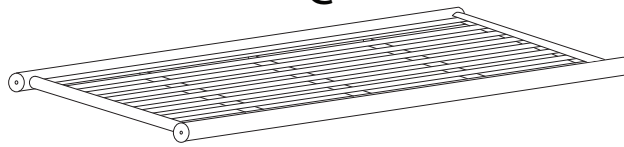

D

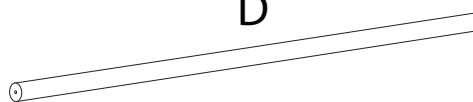

A1

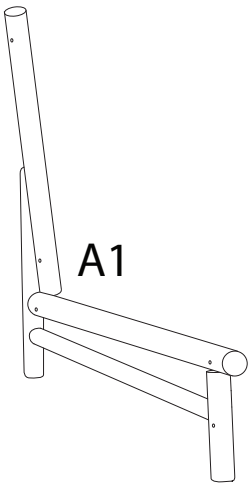

A2

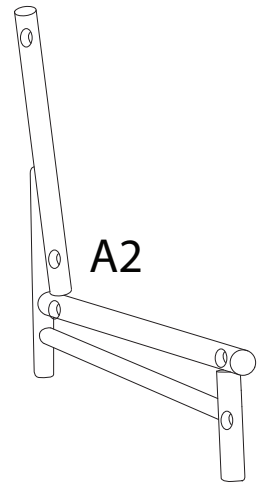

A1

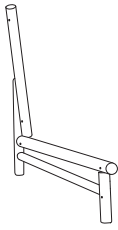

x 1

A2

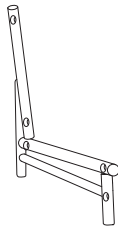

x 1

B

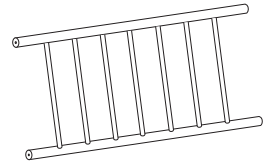

x 1

C

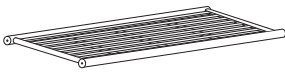

x 1

D



x 1

E



x 1

F

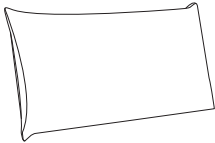

x 1

1

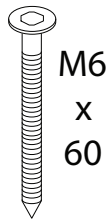

M6
x
60

x 10

2

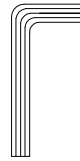

x 1

1

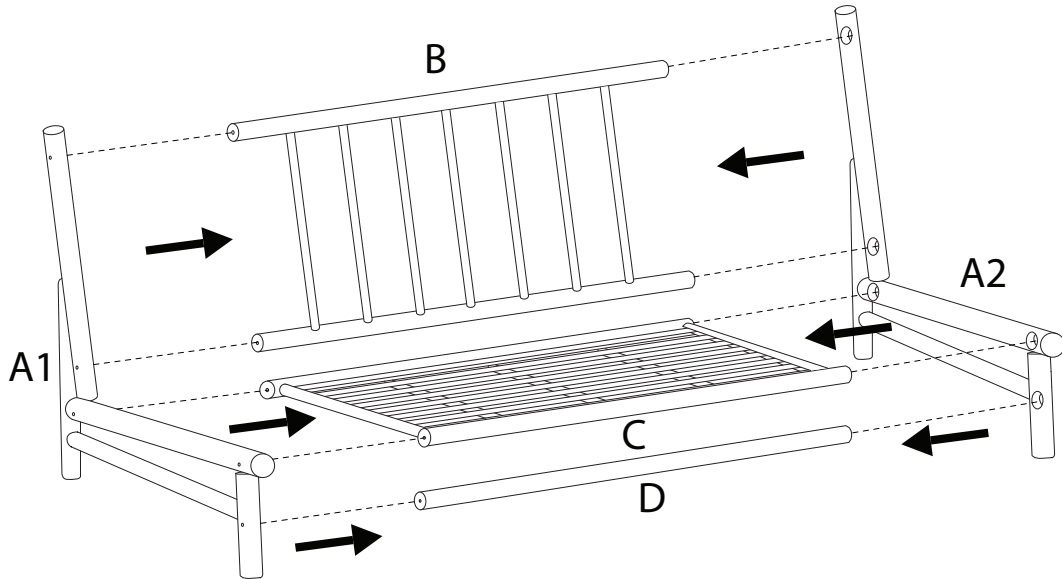
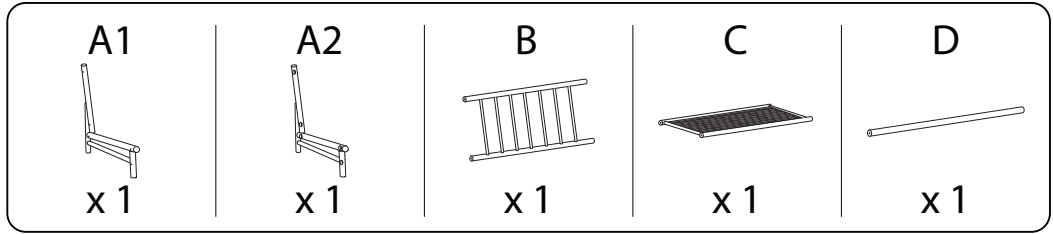

2

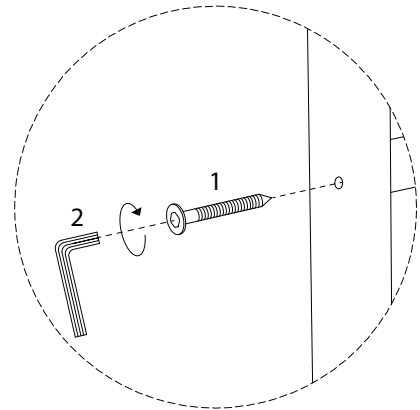
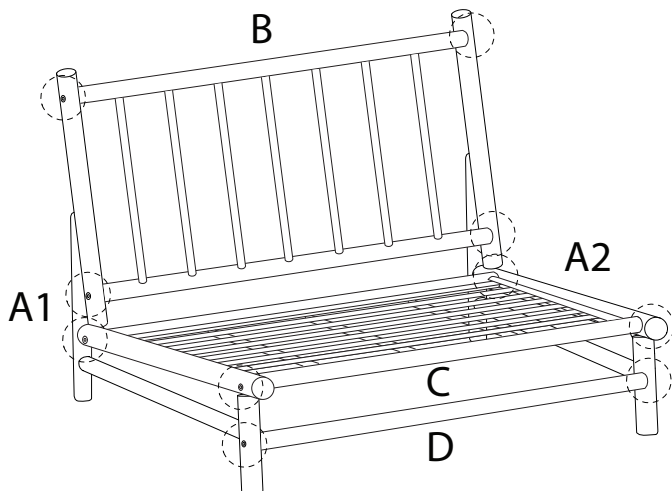
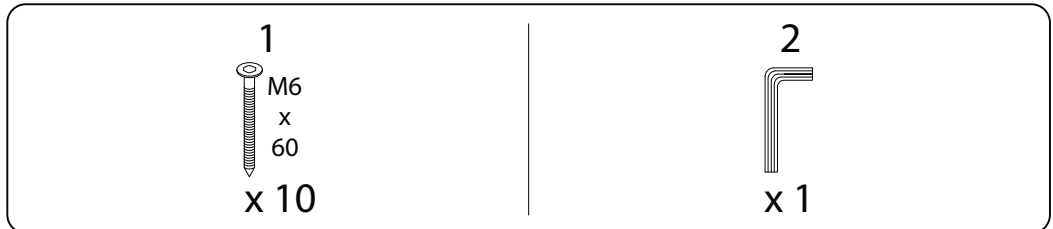

3

