

# **Aluminum Loveseat Sofa**

---

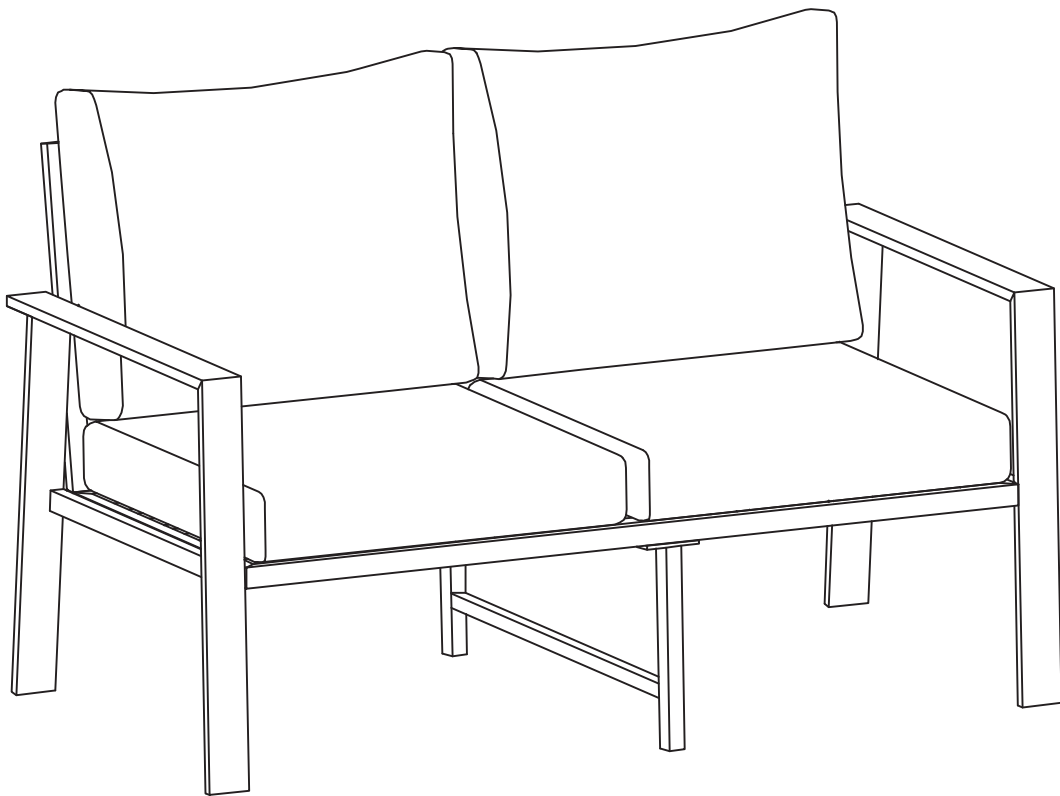

# NOTICE



Please keep these instructions for future reference.

Dear Customer

● Thank you for your purchase. When you receive the product, please make sure that all the parts are intact. Then follow the entire installation instructions to install!

● **When installing, please be careful not to tighten the screws immediately! You need to make sure that all the screws are secured to 80%, then tighten them!**

A . The outer box is damaged

B . The product is damaged / bent / cracked while you open the box

C . The parts / accessories / assembly tools are missing





D . The instructions are not clear and can not be referred

E . The product has functional problems



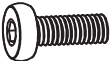
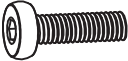

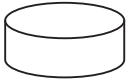
F . Other aspects that you are not satisfied with

Please feel free to contact us for help. Our after-sales team service ( will reply within 24 hours and will do our best to resolve the problem for you.

## HARDWARE LIST

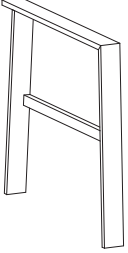
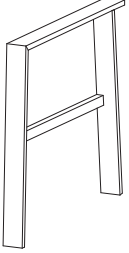
 M6*15 4 pcs	 M6*30 9 pcs	 M6*40 2 pcs	 15 pcs	 nut cap 15 pcs
 1 pc				

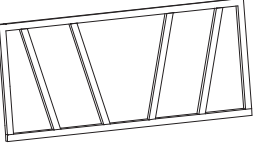
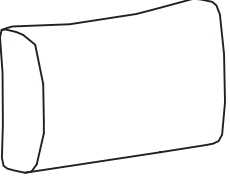
# PART LIST

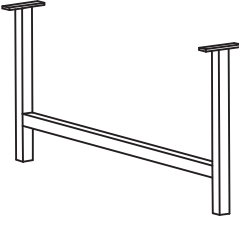
			
1 pc	1 pc	1 pc	1 pc
			
2 pcs	2 pcs	1 pc	





1. Please ensure that all accessories are complete before starting the installation.
2. Due to the variety of accessories, many accessories may be glued together, please check carefully
3. If any accessories are missing or damaged, please contact the seller immediately.

# STEP 1

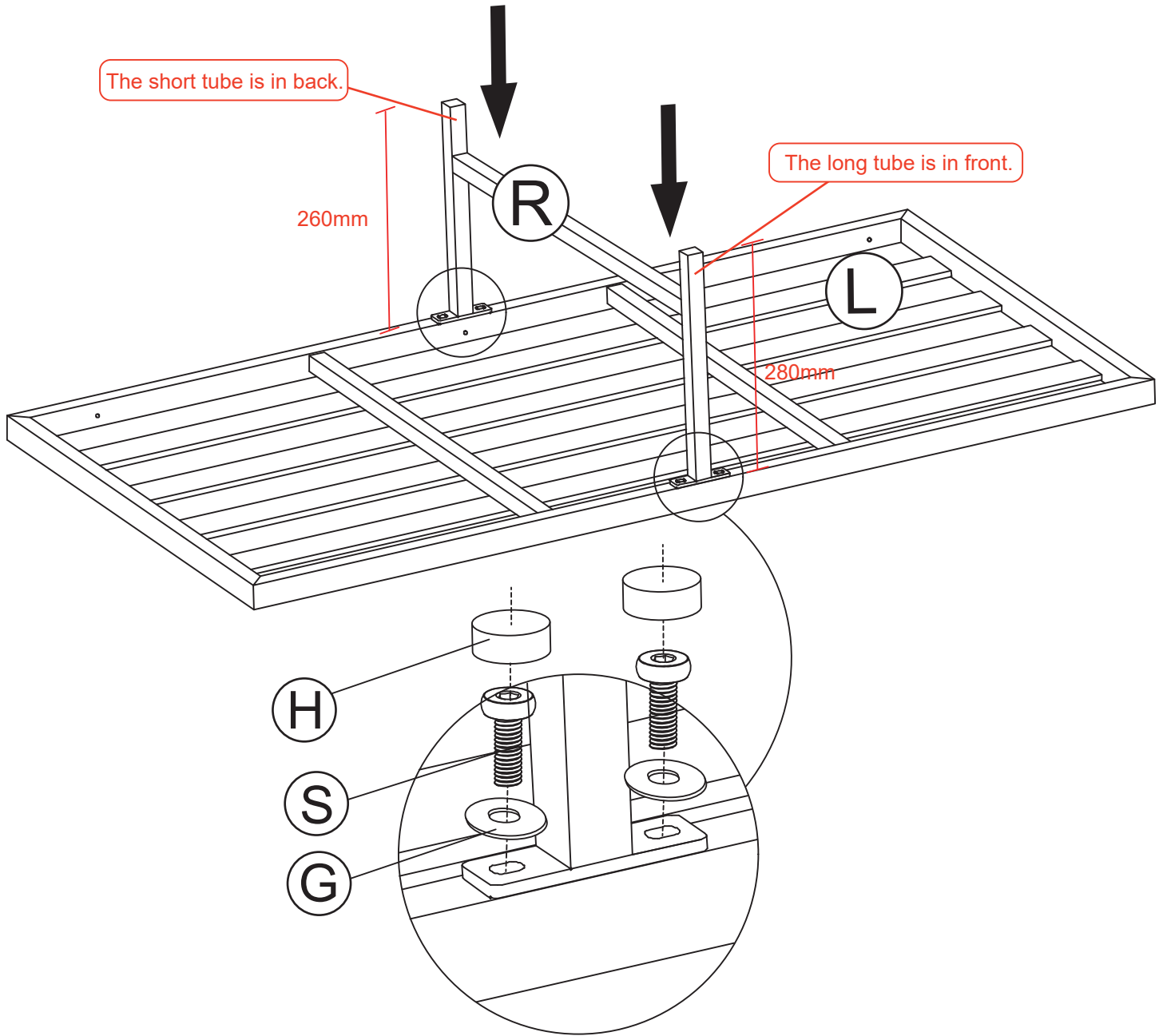
## NOTICE

When installing, please be careful not to tighten the screws immediately!  
You need to make sure that all the screws are secured to 80%, then tighten them!

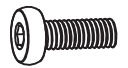

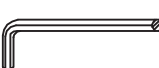
				
1 pc	4 pcs	M6*15 4 pcs	nut cap 4 pcs	1 pc

# STEP 2



The middle foot assembly should pay attention to the short tube is in back, the long tube is in front.

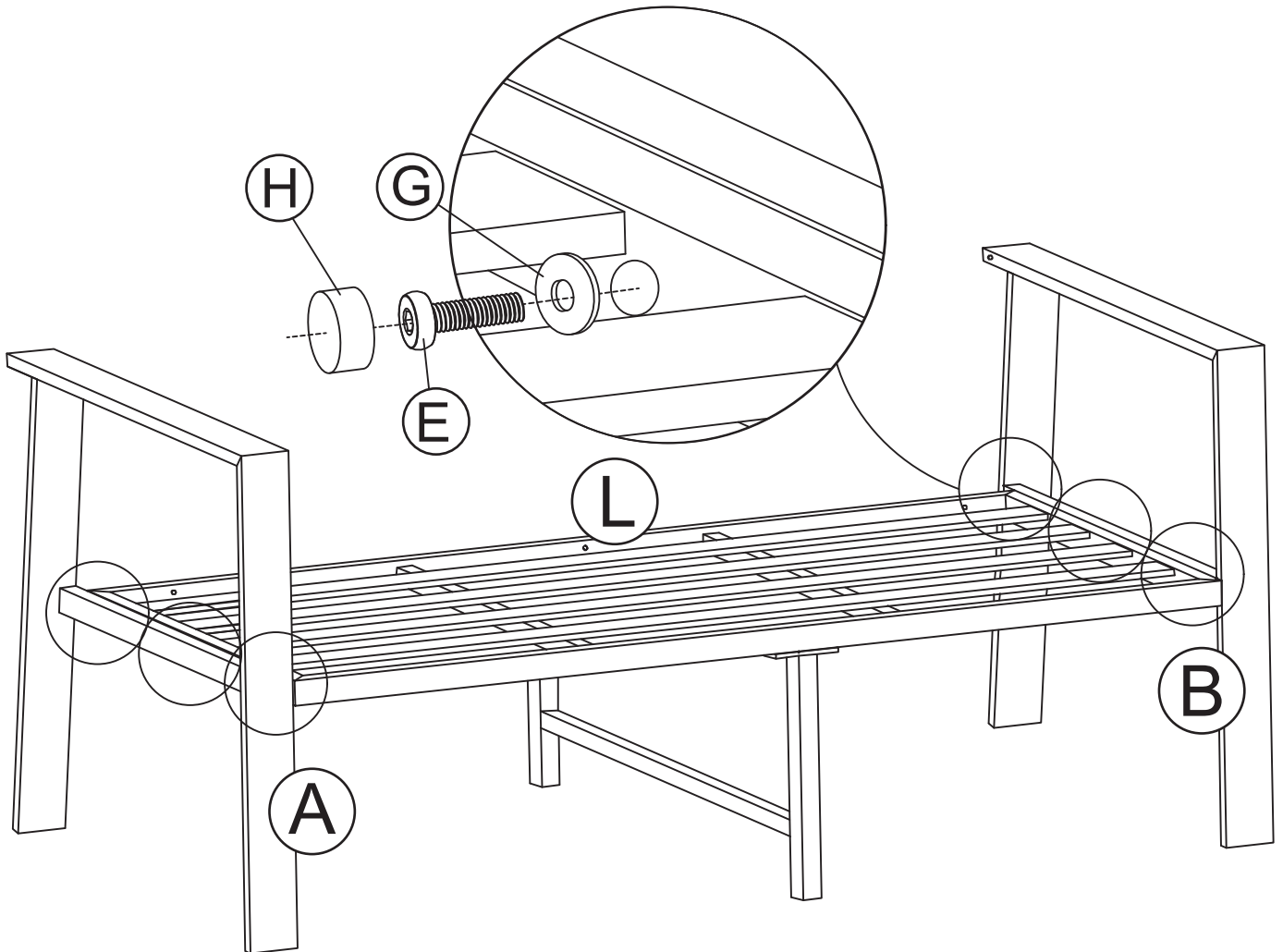





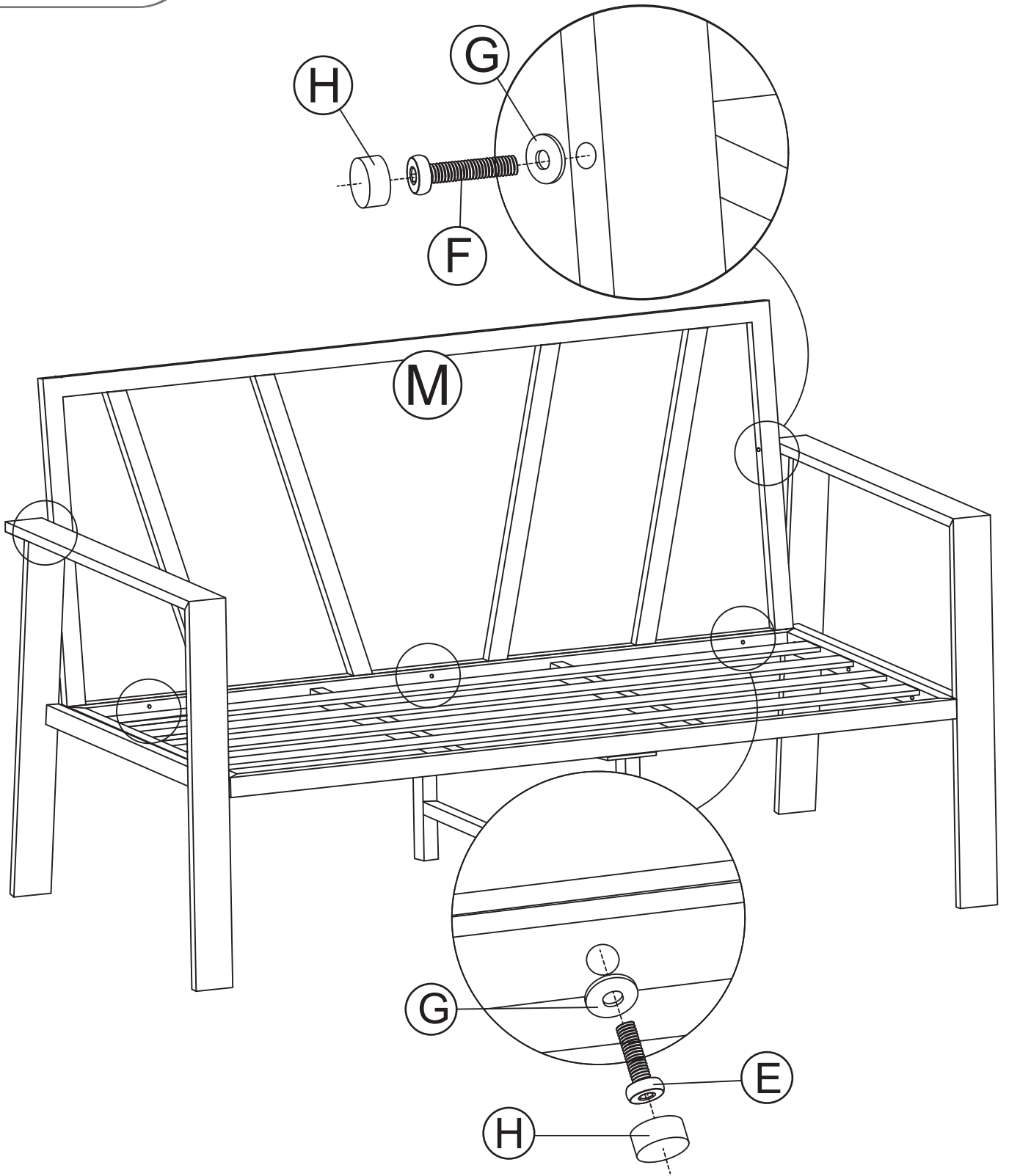

The midfoot is designed to leave a 5mm gap from the ground to avoid the problem of the middle being higher than the surroundings when encountering uneven terrain. This is not a product defect. When people sit down, the midfoot will touch the ground to provide support.

			<p>M6*30</p>	
1 pc	1 pc	1 pc	6 pcs	6 pcs

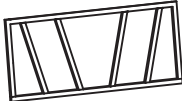
<p>nut cap</p>	
6 pcs	1 pc



# STEP 3

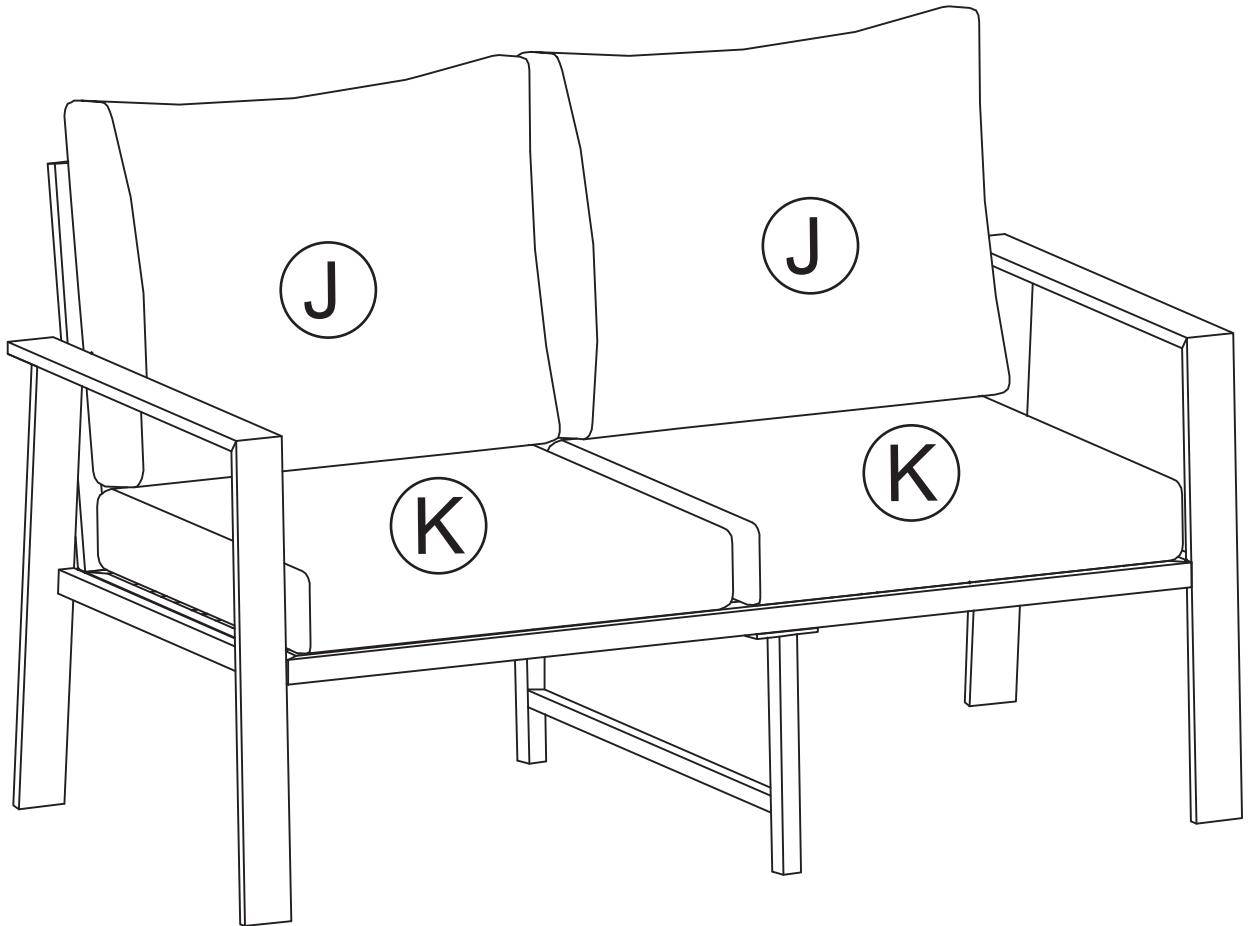

	 M6*30	 M6*40	 nut cap	 5 pcs	 1 pc
1 pc	3 pcs	2 pcs	5 pcs	5 pcs	1 pc

# STEP 4

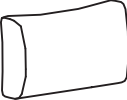

<p>ⓐ</p> 	<p>ⓑ</p> 
<p>2 pcs</p>	<p>2 pcs</p>

## STEP 5

---

**The installation is complete.  
Make sure all the screws are fully tighten.**

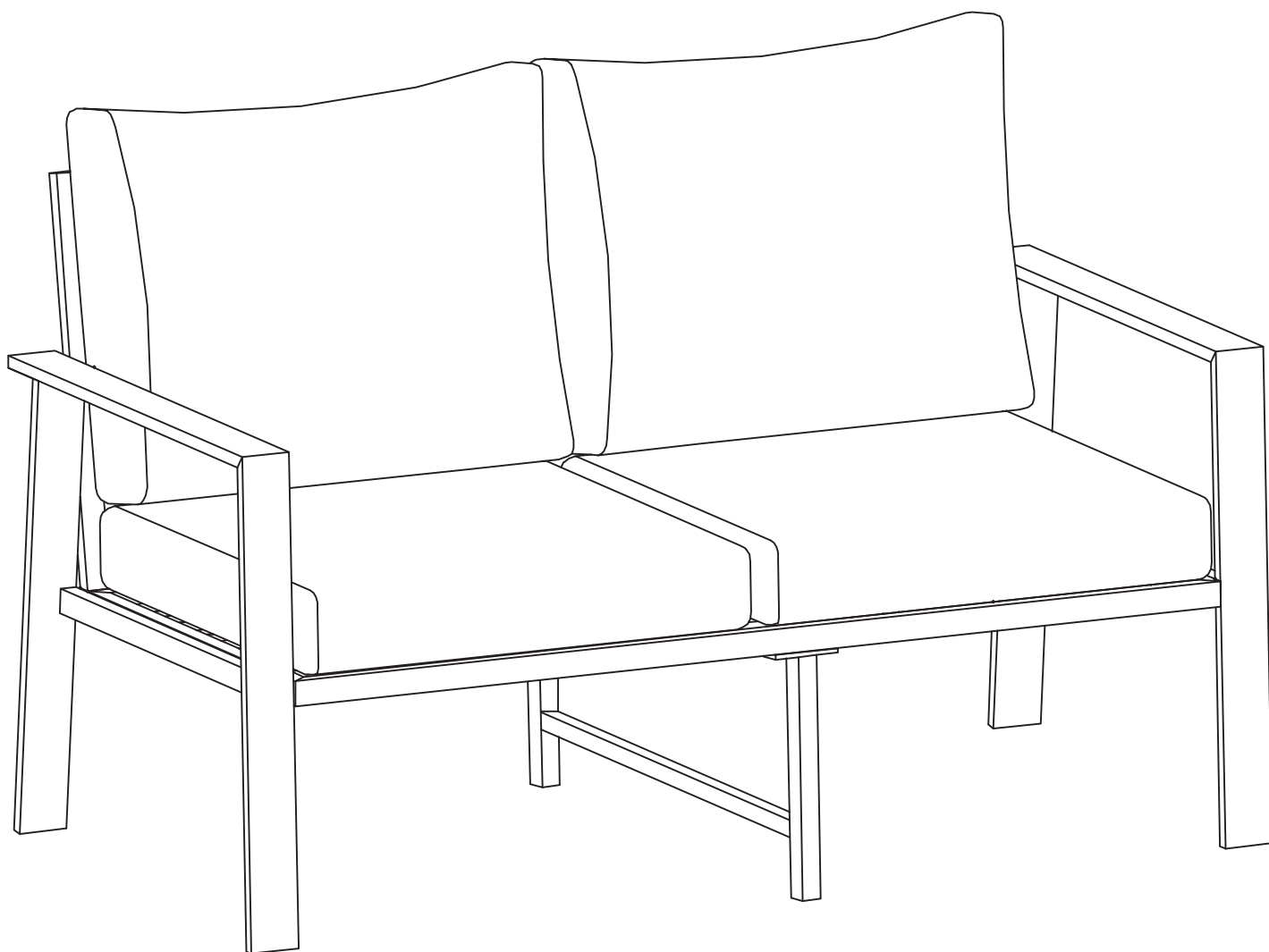

# AFTER-SALE SERVICE CARD

If you have any suggestions for our products or find that the products have quality problems, please contact us first, our after-sales team will reply you within 24 hours, and we will do our best to give you solutions until you are satisfied.

## Guaranteed Customer Service

Your shopping experience is very important to us!  
Feel unsatisfied? **Contact us!**  
Have any questions? **Contact us!**

Wanna share how wonderful our smart products makes your home?  
Share your pictures with us.  
Any suggestions? **Contact us!**  
We gotcha back!