

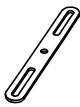

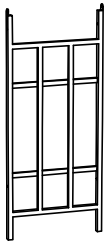

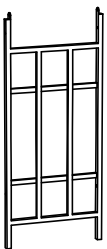

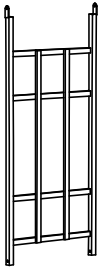

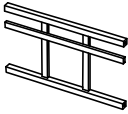
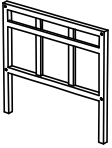
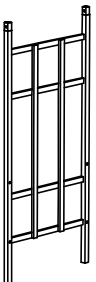
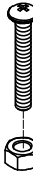

ASSEMBLY INSTRUCTIONS

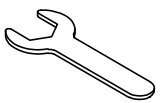
<p>1</p>  <p>4pcs</p>	<p>2</p>  <p>1pc</p>	<p>3</p>  <p>1pc</p>	<p>4</p>  <p>2pcs</p>	<p>5</p>  <p>4pcs</p>	<p>6</p>  <p>2pcs</p>
<p>H</p>  <p>2pcs</p>	<p>a</p>  <p>M6*35mm</p> <p>6pcs</p>	<p>b</p>  <p>M6*30mm</p> <p>8pcs</p>	<p>c</p>  <p>M6*30mm</p> <p>16pcs</p>	 <p>1pc</p>	 <p>1pc</p>

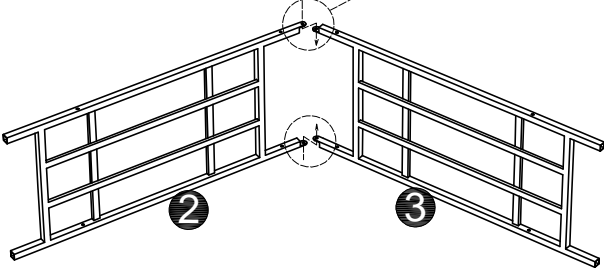
<p>1 a x2</p>  <p>Tighten the screws to 50% tightness</p> 	<p>2 a x4</p>  <p>Tighten the screws to 50% tightness</p> 
<p>3 b x4</p>   <p>Adjust the balance and width you need, then tighten all screws to 100% tightness</p>	<p>4 c x4</p> 

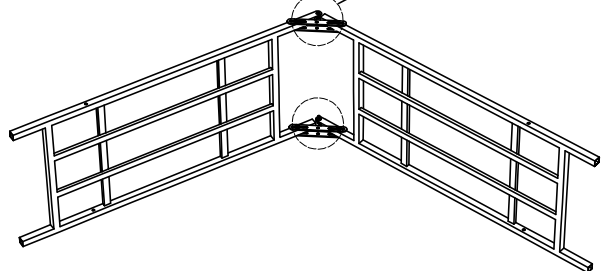
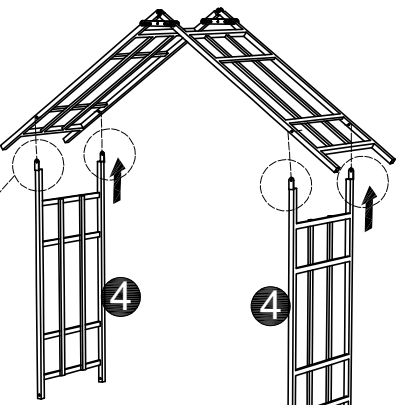
5

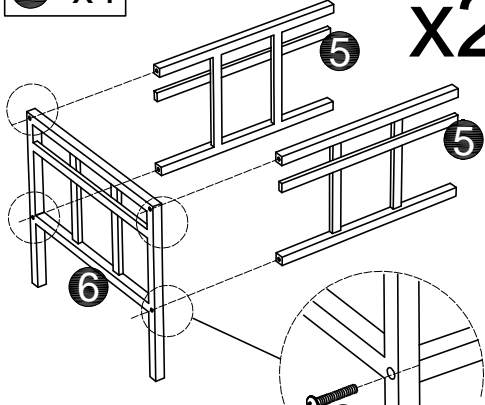
c x4

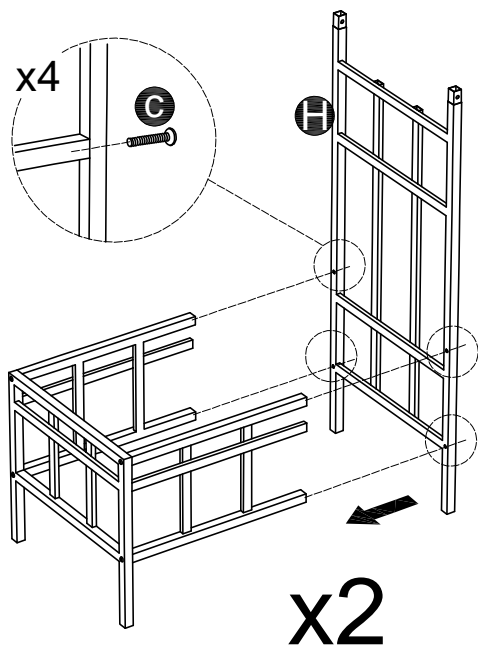

6

b x4

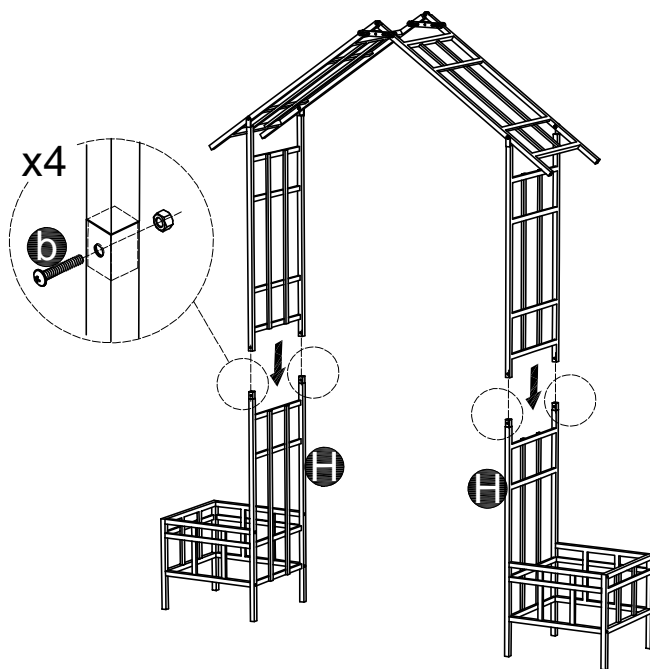

7

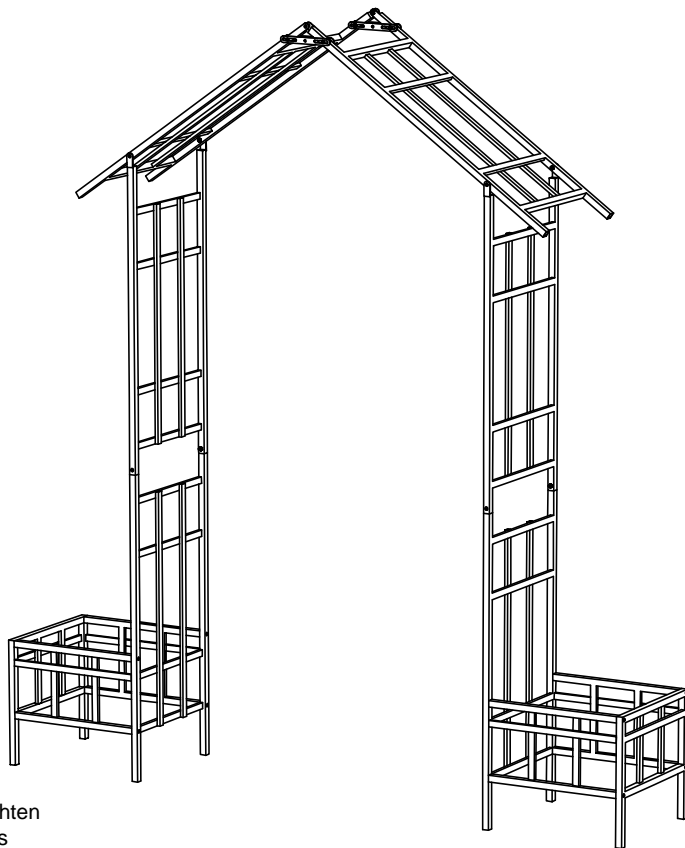

Adjust the balance, then tighten
all screws to 100% tightness

Option-1

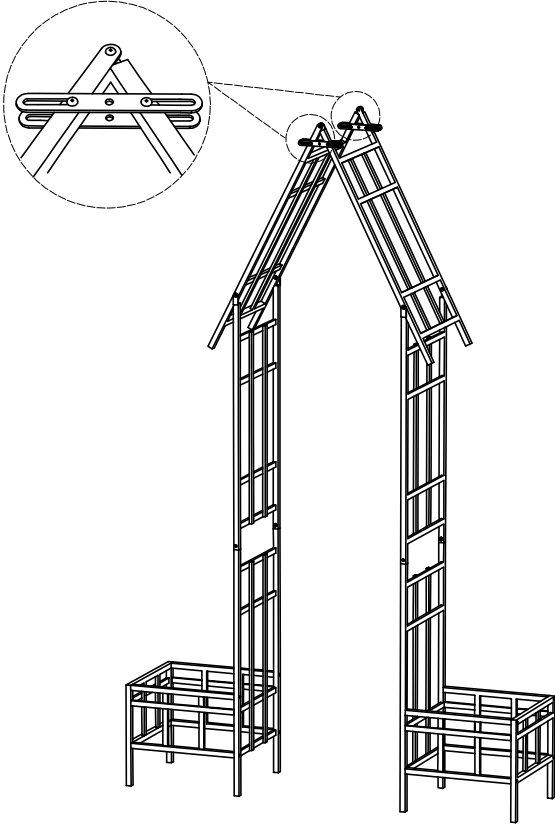

Option-2

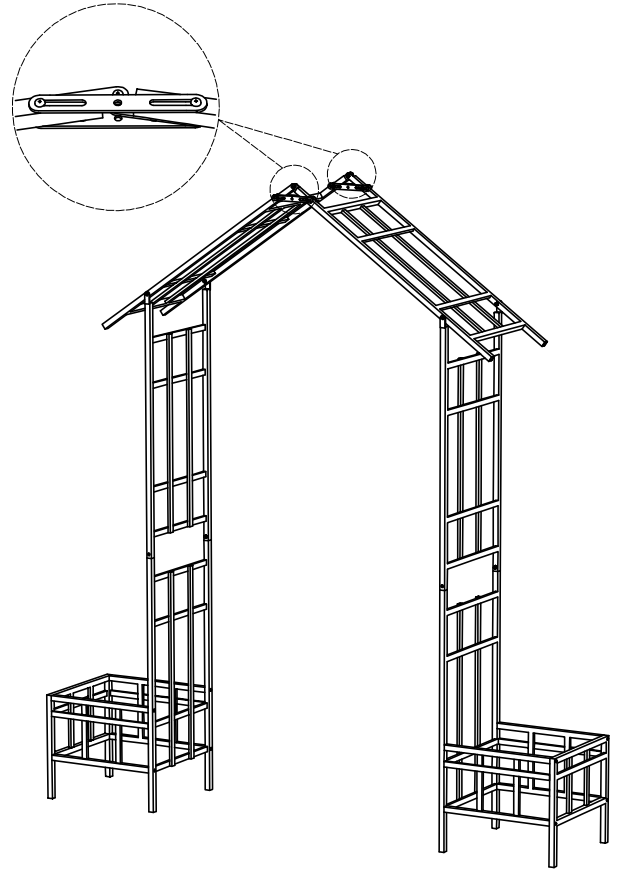

Option-3

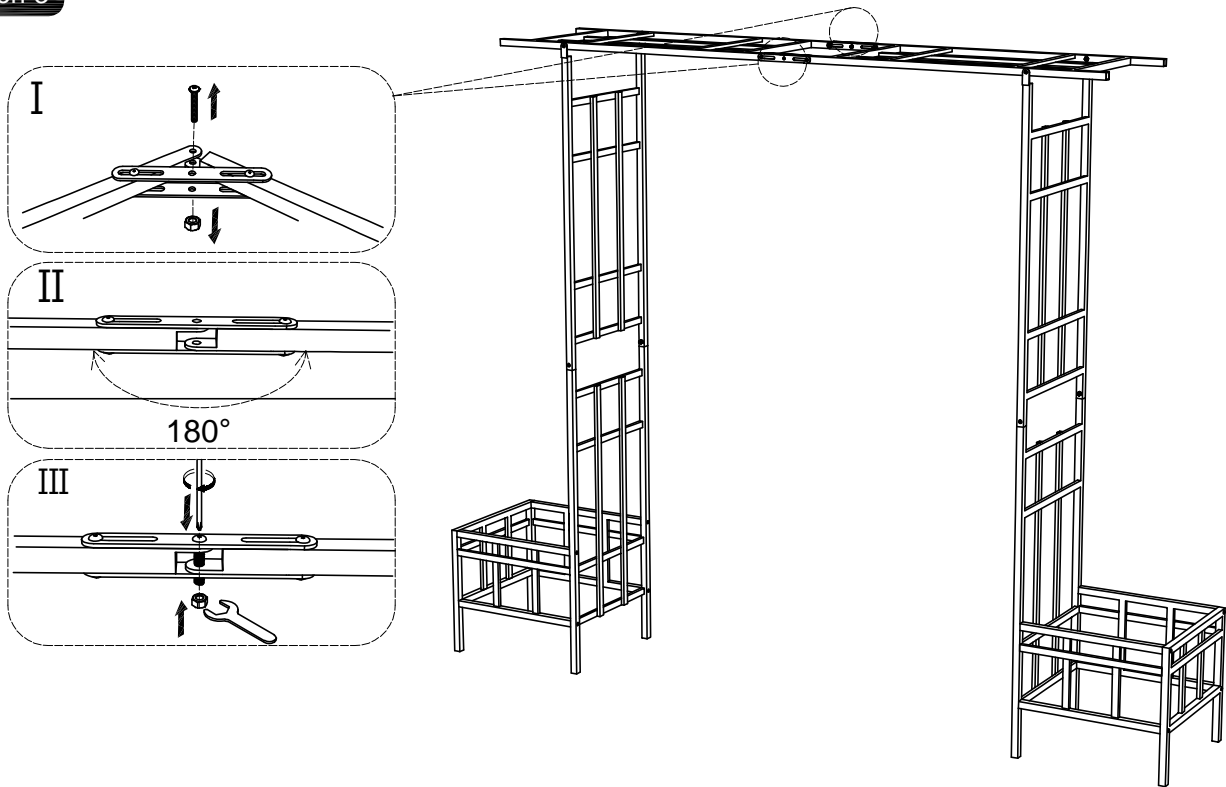

The width of the Arch can be freely adjusted through the top flat iron.
Channel widths range from 34.3 " to 60.4".