

INSTALLATION INSTRUCTIONS

Bathroom Vanity

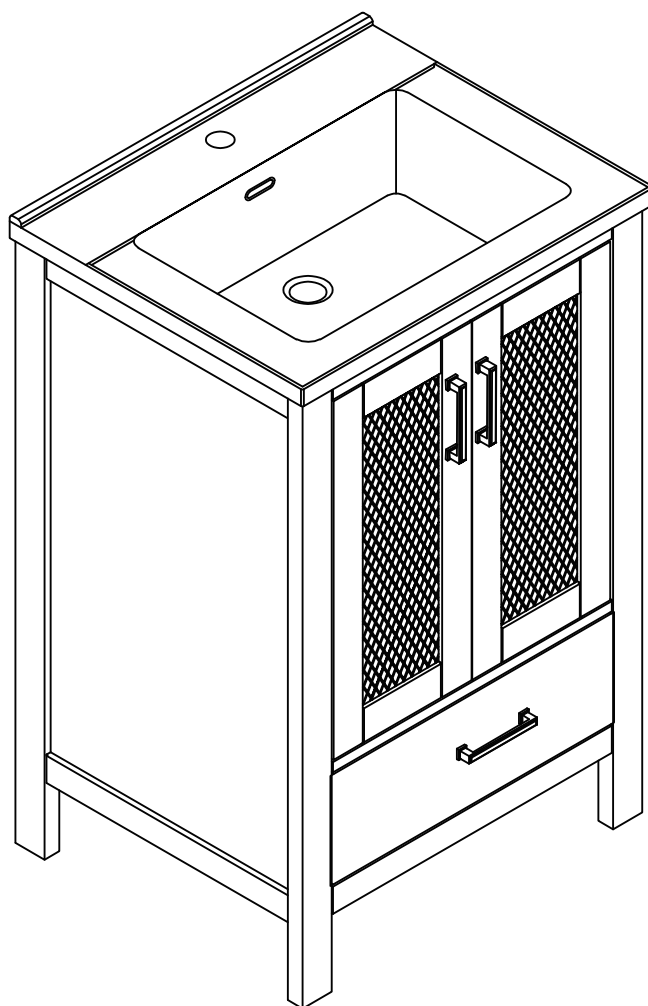

Drawings may not accurately depict product contours.



Prior to Installation:

- **Ensure all necessary accessories are included. If any parts are missing, contact us immediately.**
- **Due to the size and weight of the cabinet, we recommend that two adults handle it on a carpeted or padded area in the intended room.**
- **Only use the tools provided or recommended in these instructions.**

General Recommendations:

Spend a few moments familiarizing yourself with this manual before proceeding with the instructions. Always use the appropriate tools and wear necessary safety gear to protect yourself.

INSTALLATION INSTRUCTIONS

PACKAGE CONTENTS

- Ceramic Basin/Countertop
- Vanity Base/Cabinet

DIMENSIONS

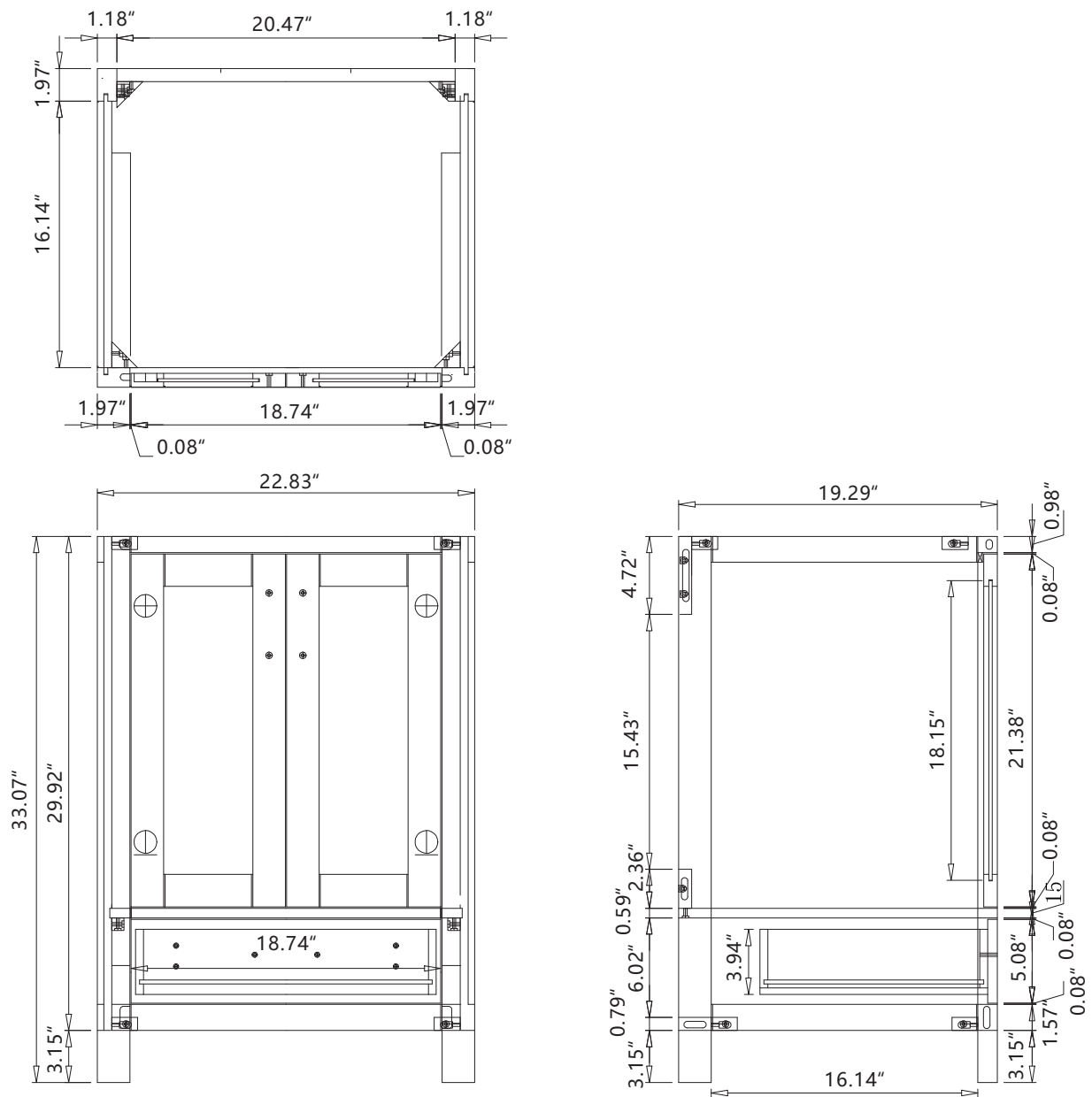

Drawings may not accurately depict product contours.

INSTALLATION INSTRUCTIONS

INSTRUCTIONS

● Recommended Tools

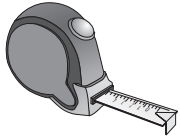

Tape measure

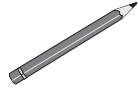

Pencil

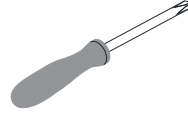

Screwdriver

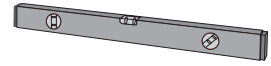

Level

● Install, Remove, Or Adjust the Top Fast-Loading Hinge

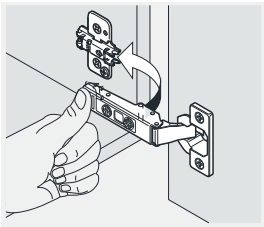

Install

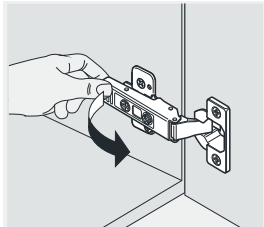

Remove

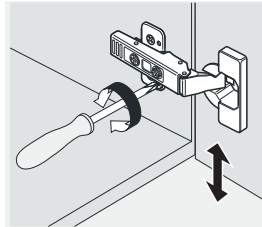

Adjust the height

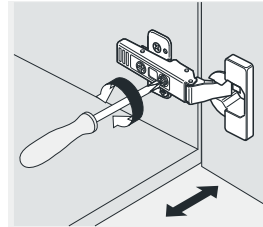

Adjust the lateral

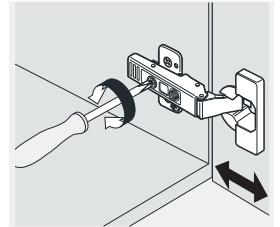

Adjust the depth

● Installing the Pop-up, Faucet, and Basin (Not Included)

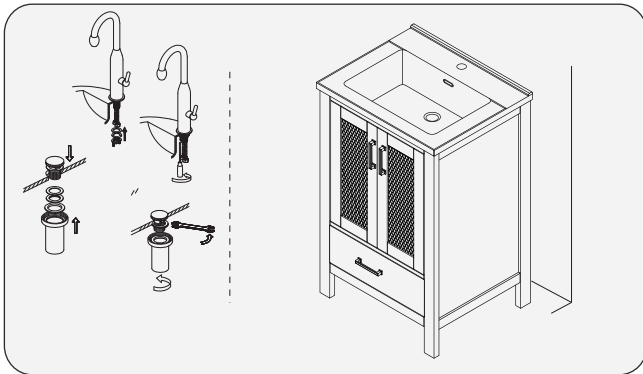

● Uninstall the drawers.

Removal of slide rail with front connector:

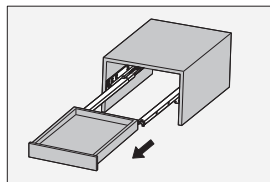
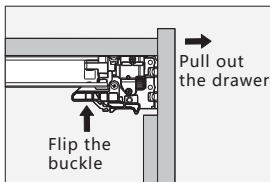

*Flip the buckle of the front connector, then pull the drawer out to disassemble it.

Drawings may not accurately depict product contours.

INSTALLATION INSTRUCTIONS

VANITY CARE GUIDE

Vanity Care

- Avoid direct contact with sharp objects to prevent exterior damage.
- Protect from direct sunlight to prevent aging and cosmetic damage.
- Refrain from placing hot objects directly onto the vanity surface.

Countertop Care

- Our tops are sealed before shipping but may stain, scratch, or chip due to their porous nature.
- Avoid placing hot items directly on the countertop to prevent damage.
- Immediately dry to prevent ring marks or staining.
- Use table mats under potentially scratching objects.
- Dust the vanity with a clean, soft fabric.
- Periodically clean with a cloth dampened in warm water. Use mild dishwashing liquid or stone soap if necessary, then dry with a soft cloth.
- Avoid chemical cleaners, abrasive products, or those containing lemon, vinegar, or acids.
- Reseal the top annually or as needed.

Cleaning and Maintenance

- Avoid using products containing bleach or ammonia.
- Use wood-friendly products on wooden base vanities.
- Use natural cleaning solutions or soap for exterior surfaces.

Drawings may not accurately depict product contours.