

# ASSEMBLY INSTRUCTIONS

MODEL # \_\_\_\_\_

**MODEL #  
SL-AC8000**

## TOOLS REQUIRED



Screwdriver  
( Not included)

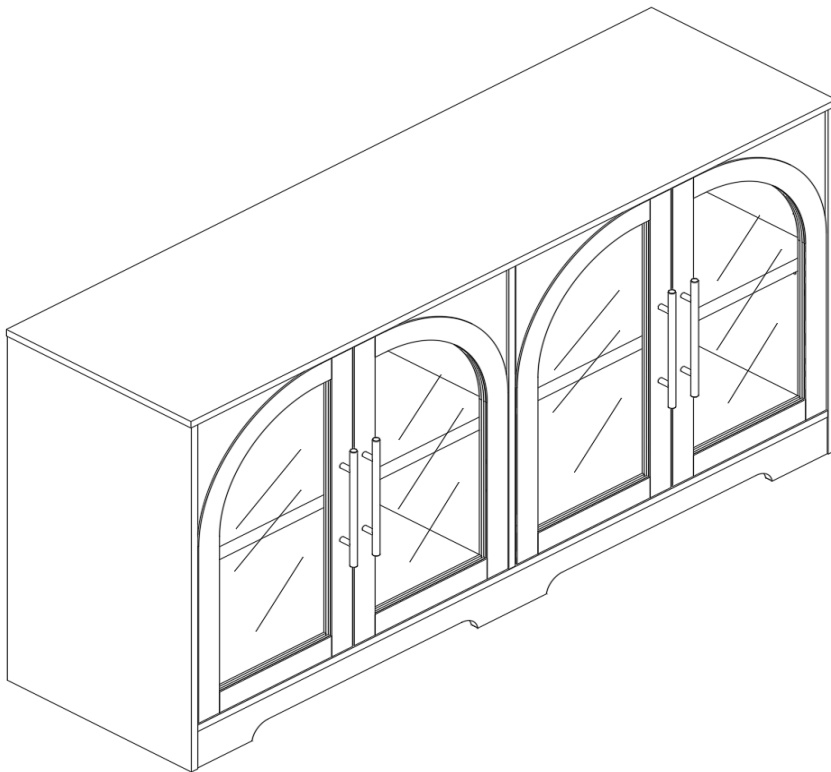

2 - People

## ASSEMBLY RATING



EASY —————> DIFFICULT

The Assembly Rating is a 5-point system showing the level of effort needed to assemble a specific product.



## **CHECK BEFORE STARTING**

### **Are you missing anything?**

Double-check all parts, hardware and accessories listed are all accounted for.

### **Should we send any replacements?**

Are there any irregularities or flaws in the parts? We can send replacements!

### **Check out our Quick Tips!**

We recommend reviewing the pre-assembly handouts. Even experts need a refresher now and then!

### **Prep Time!**

Please review the assembly instructions and all diagrams prior to assembling.

# PRE ASSEMBLY INTRODUCTION

We understand building ready-to-assemble furniture can be a challenging experience for some. To help avoid confusion, we have provided some helpful tips that may speed up the process.

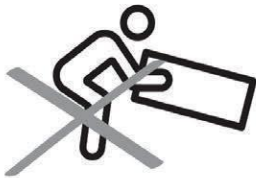

## Teamwork

ALWAYS have at least two people to help with transporting and assembling the product to avoid potential injury and/or damage.

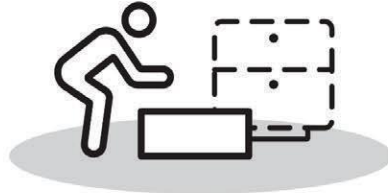
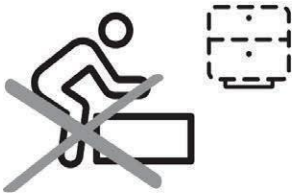

## Suitable Location

Assembling near the area of the intended location is highly recommended.



## Sufficient Space

Make sure you have enough space to move around during the assembly.



## Avoid Scratches

Use cardboard, blankets or a carpeted area while assembling furniture to prevent scratches and damages.

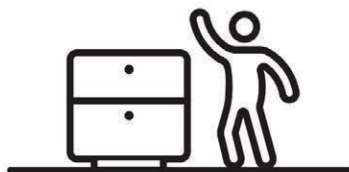
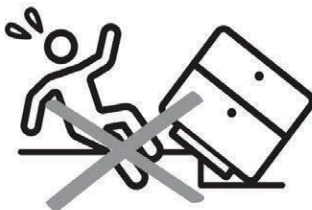

## Flat Surface

Make sure the furniture rests on a flat and level surface with each leg evenly touching the floor.

# ASSEMBLY AND CARE ADVICE



**FAILURE TO FOLLOW THE GUIDELINES BELOW MAY RESULT IN INJURY AND/OR PROPERTY DAMAGE.**



Position each part correctly and insert screws or bolts into their respective holes.

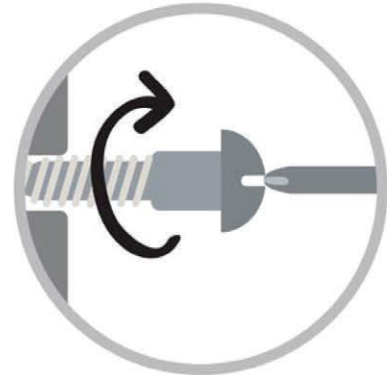

Turn clockwise to tighten and only tighten when step is completed or when instructed to do so.



Use the appropriate hand tools or power tools for assembly. Select steps, such as tightening screws and/or bolts, may require hand tools to avoid causing damage during assembly.



Save the instructions and store any supplied tools for later maintenance.



After two weeks, check and tighten any loose hardware and repeat again every six months thereafter.

**IT IS THE USER'S RESPONSIBILITY TO MAINTAIN THE FURNITURE. THE HARDWARE MAY LOOSEN OVER TIME AND MAY CAUSE THE FURNITURE TO BE WOBBLY AND UNABLE TO SUPPORT ITS INTENDED WEIGHT CAPACITY. THIS MAY LEAD TO COLLAPSE AND MAY CAUSE SERIOUS INJURY.**

# CONSOLE

---

## SL-AC8000



- Please keep instructions for future reference.
- Check the quantity and irregularity of parts and hardware before you start.

### PARTS

1

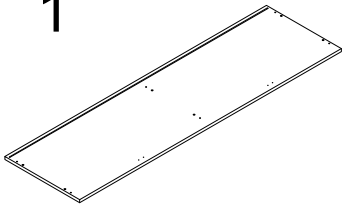

Panel  
1 pc.

2

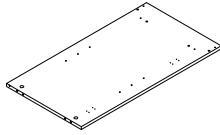

Left side panel  
1 pc.

3

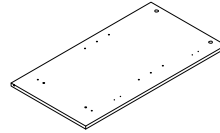

Right side panel  
1 pc.

4

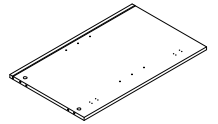

Partition panel  
1 pc.

5

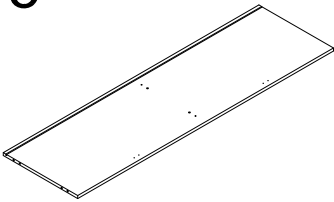

Bottom Panel  
1 pc.

6

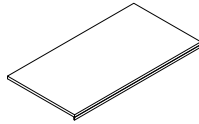

Shelf  
2 pcs.

7

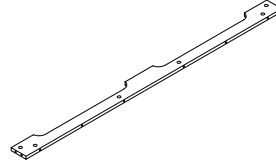

Front apron  
1 pc.

8

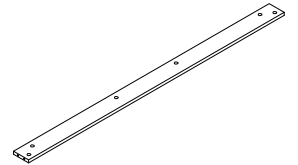

Rear apron  
1 pc.

9

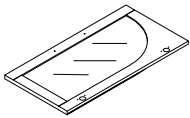

Left door  
2 pcs.

10

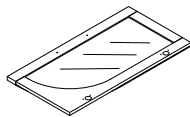

Right door  
2 pcs

11

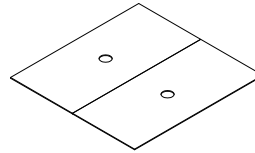

Back panel  
2 pcs.

# HARDWARE

**A**

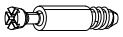

(22+1) pcs.  
Cam Bolt  
Ø6\*33 pc.

**B**



(22+1) pcs.  
Cam Lock  
Ø15x10mm

**C**

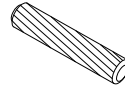

(20+1) pcs  
Dowel  
Ø8x30mm

**D**

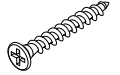

2 pcs  
Screw  
Ø4x38mm

**E**

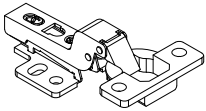

8 pcs  
Europe Hinge  
Ø35

**F**



(48+2) pcs  
Screw  
Ø3.5x12mm

**G**

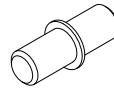

8 pcs  
Shelf support pin  
Ø5x16mm

**H**



(16+1) pcs  
Screw  
Ø3.5x12mm

**I**



(16+1) pcs  
Plastic Wedge

**J**



8 pcs  
Screw  
Ø3.5x12mm

**K**

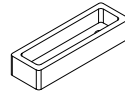

4 pcs.  
Door stopper

**L**



8 PCS  
Handle bolt  
5/32\*25mm

**M**

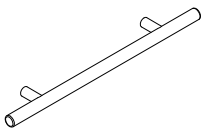

4 PCS  
Handle  
1 pc.

**N**



6 pcs  
Cam Cover  
Ø3.5x12mm

**O**

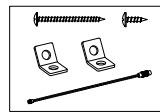









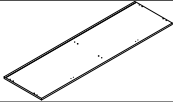
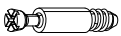
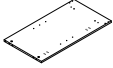

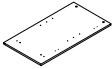

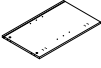
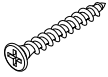
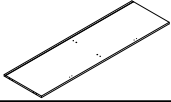
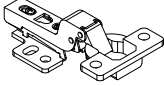

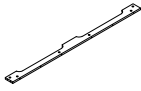
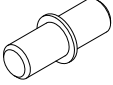
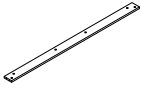

2 pcs.  
Tipping Restraint Hardware

**P**

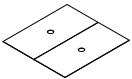
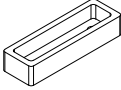

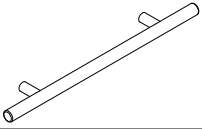
2 pcs.

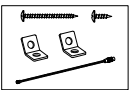
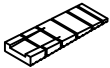
Carton	Designation	Part		Hardware	
<b>SL-AC8000</b>	Panel(1pc)	1			A 22 pcs.
	Left side panel(1pc)	2			B 22 pcs.
	Right side panel(1pc)	3			C 20 pcs.
	Partition panel(1pc)	4			D 2 pcs.
	Bottom Panel(1pc)	5			E 8 pcs.
	Shelf(2pcs)	6			F 48 pcs.
	Front apron(1pc)	7			G 8 pcs.
	Rear apron(1pc)	8			H 16 pcs.
	Left door (2pcs)	9			I 16 pcs.
	Right door (2pcs)	10			J 8 pcs.
	Back panel(2pcs)	11			K 4 pcs.
					L 8 pcs.
					M 4 pcs.
					N 6 pcs.
					O 2 pcs.
					P 2 pcs.

# ASSEMBLY INSTRUCTIONS

1

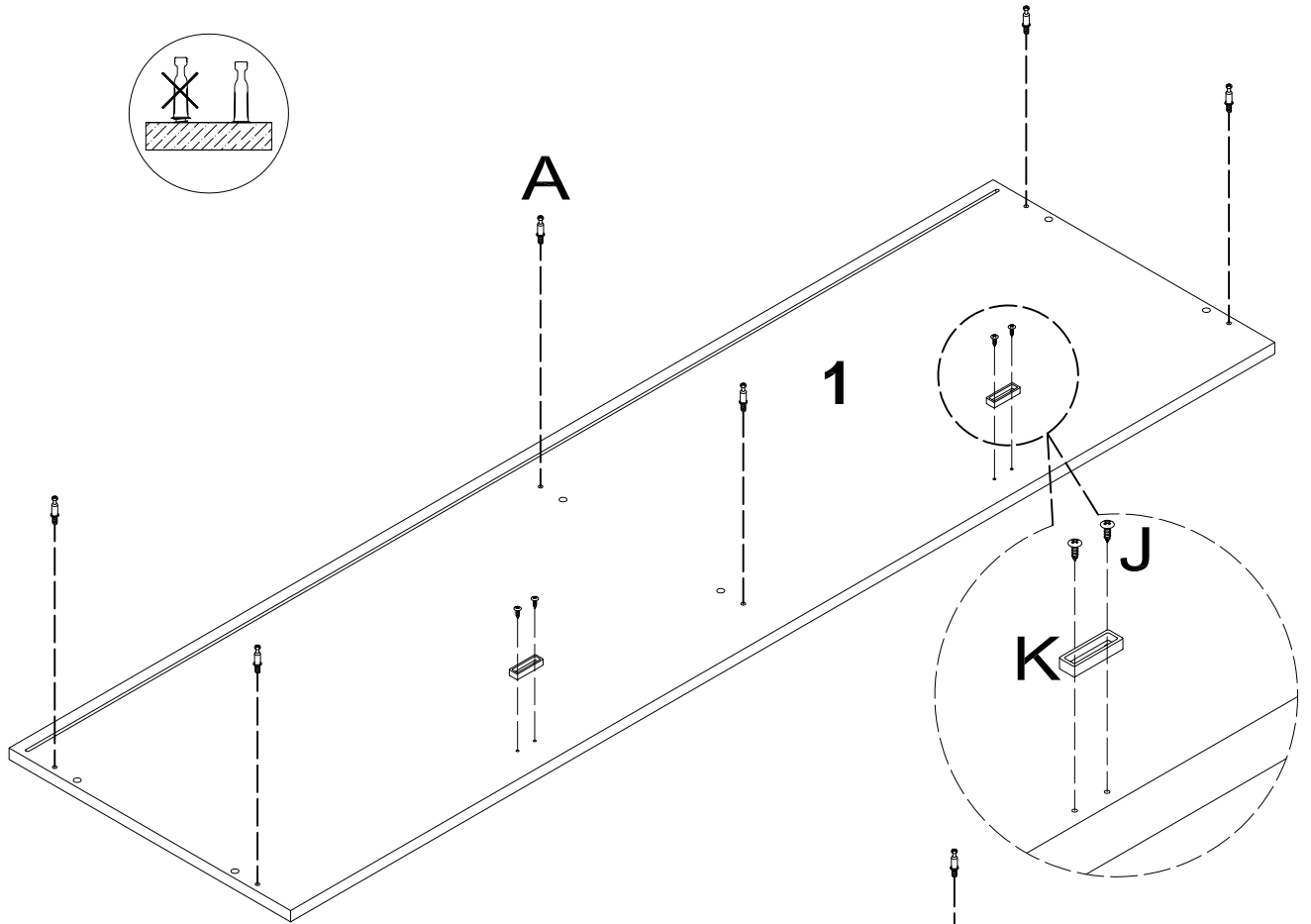

2

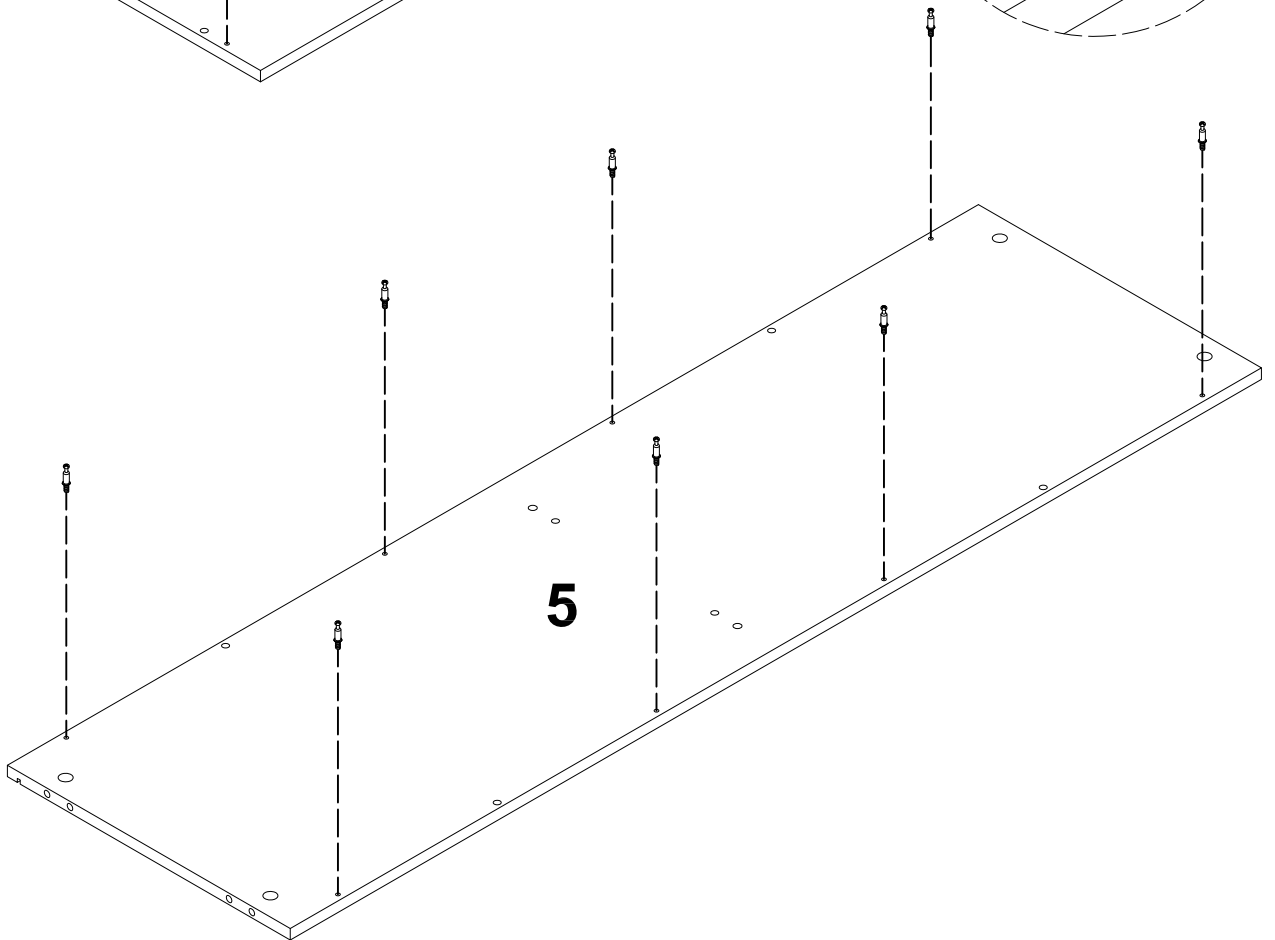

# ASSEMBLY INSTRUCTIONS

3

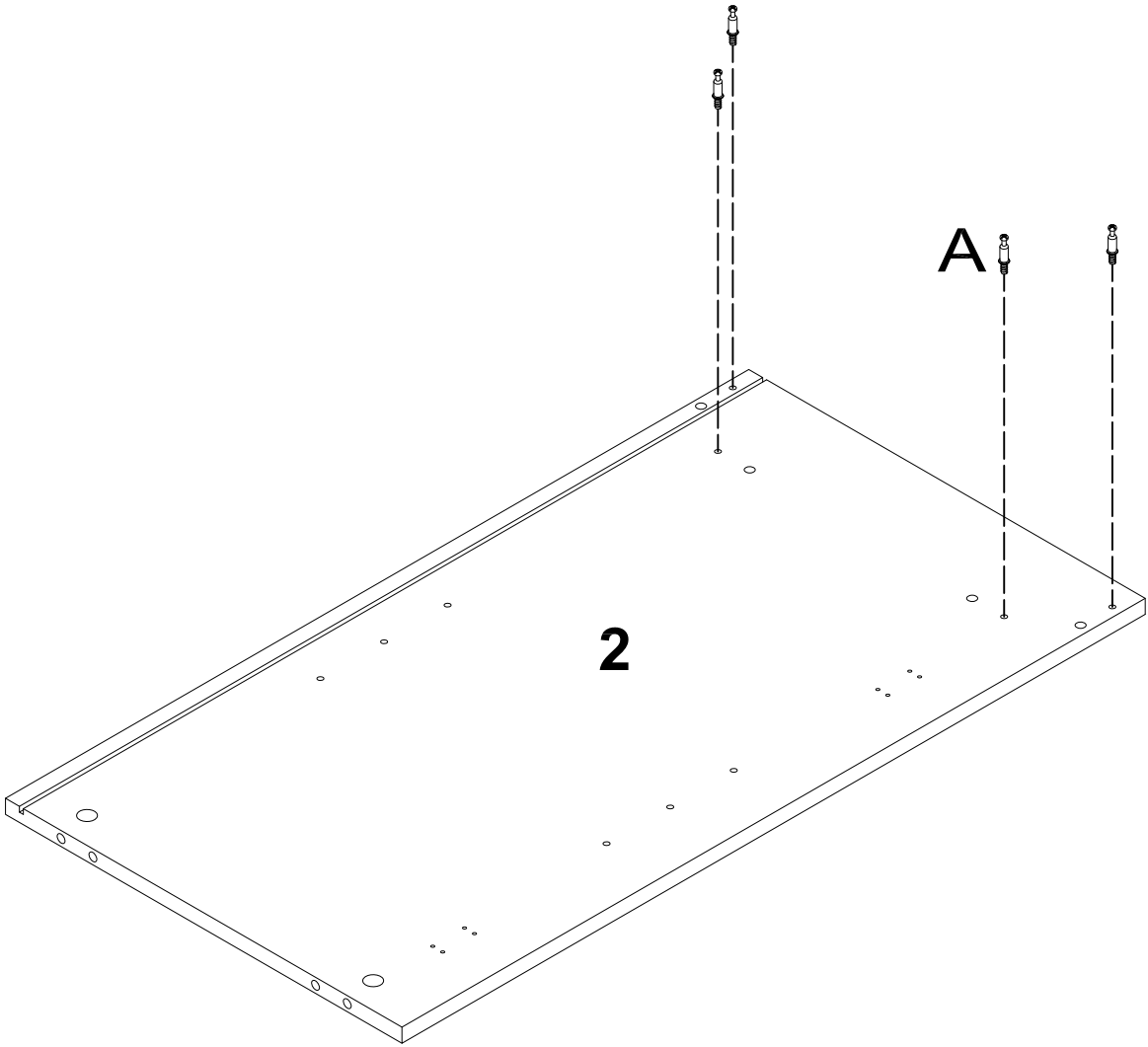

4

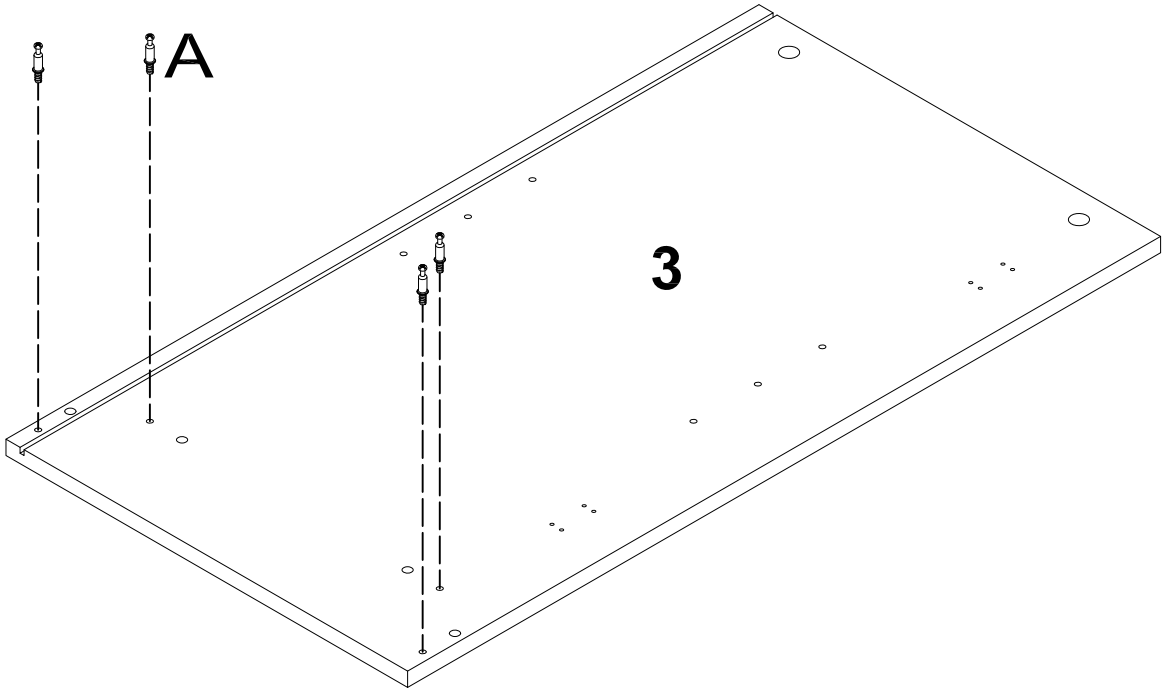

# ASSEMBLY INSTRUCTIONS

5

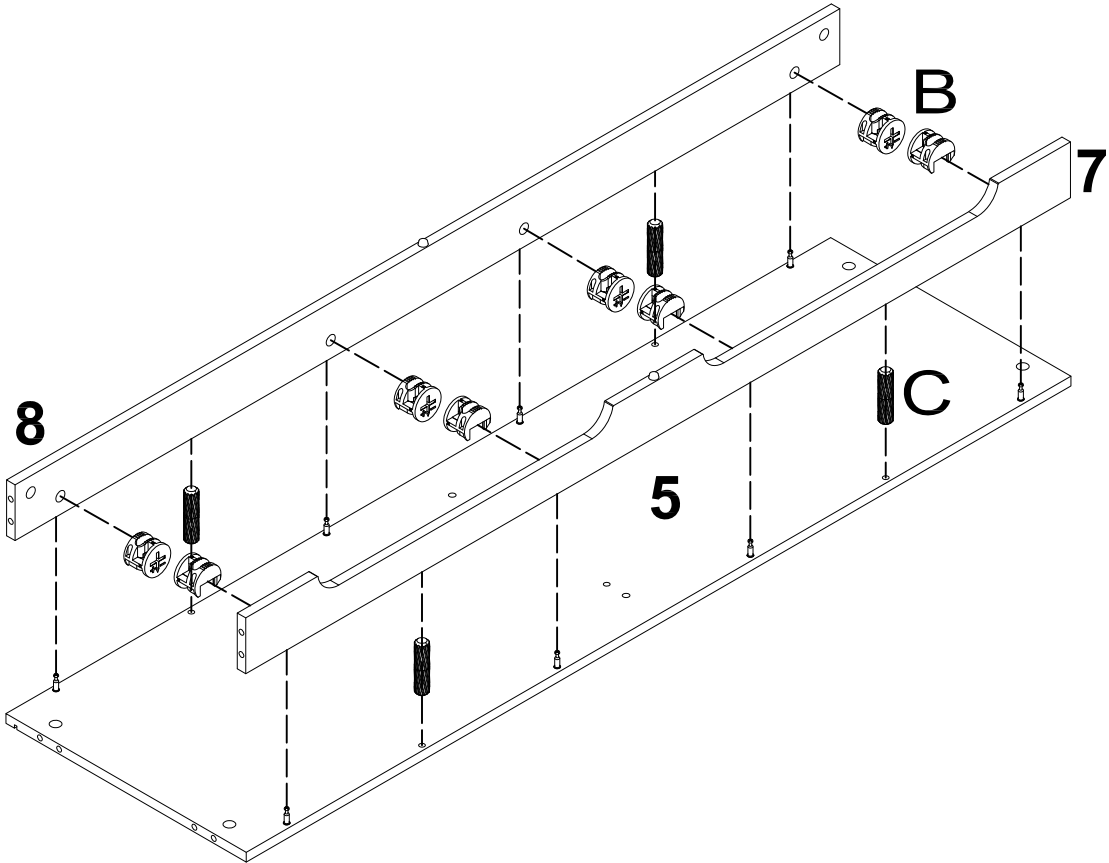

6

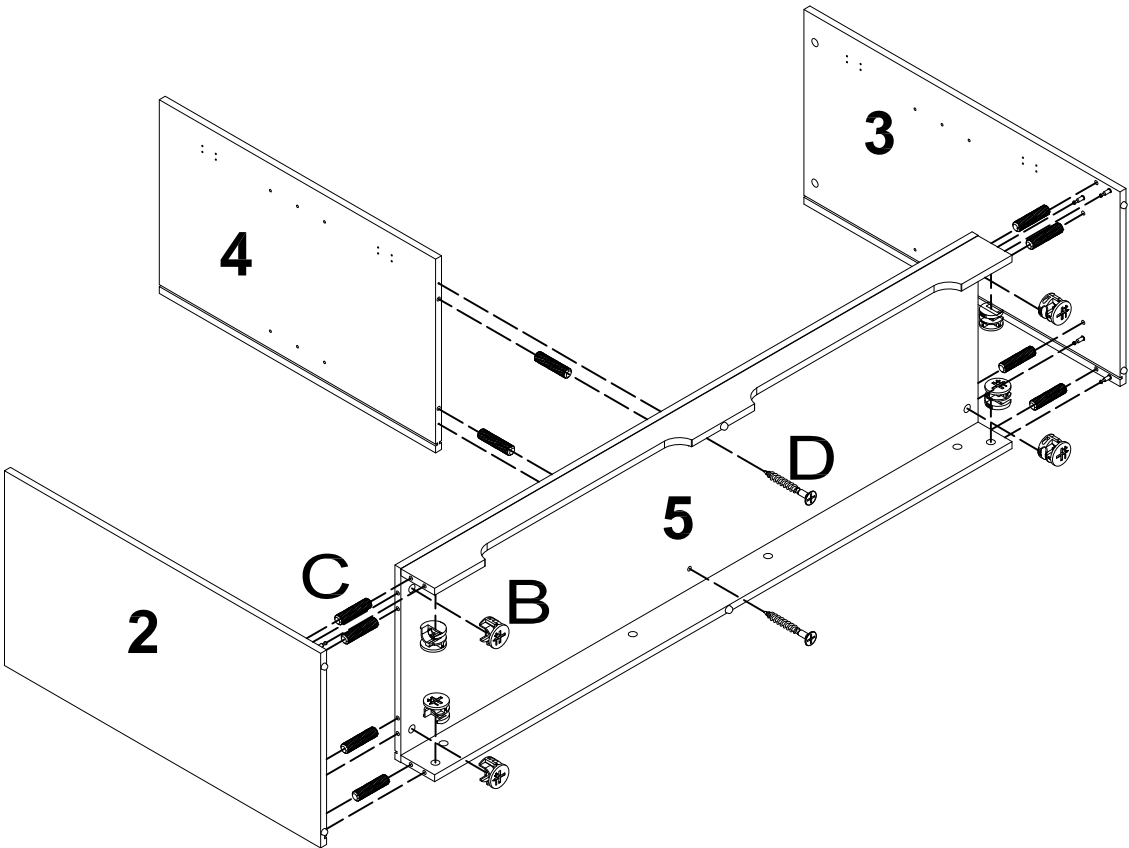

# ASSEMBLY INSTRUCTIONS

7

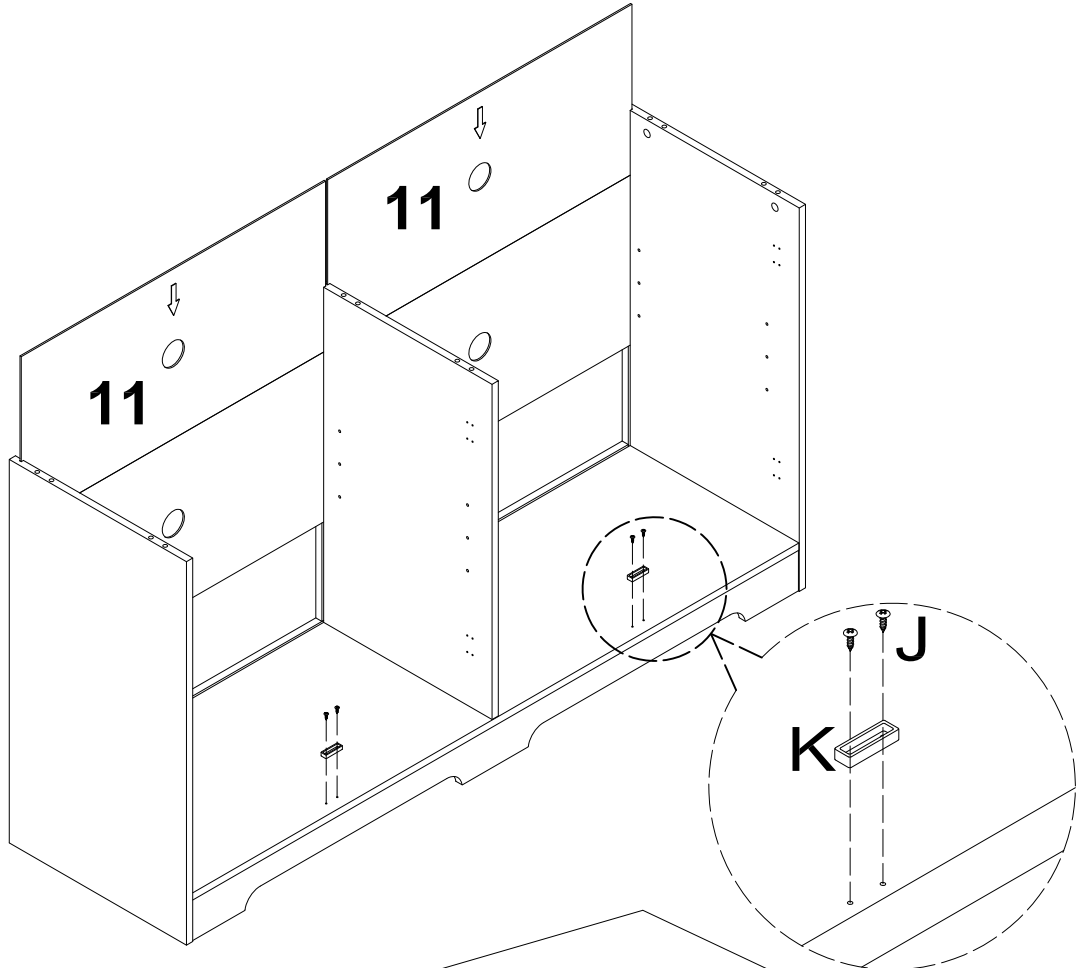

8

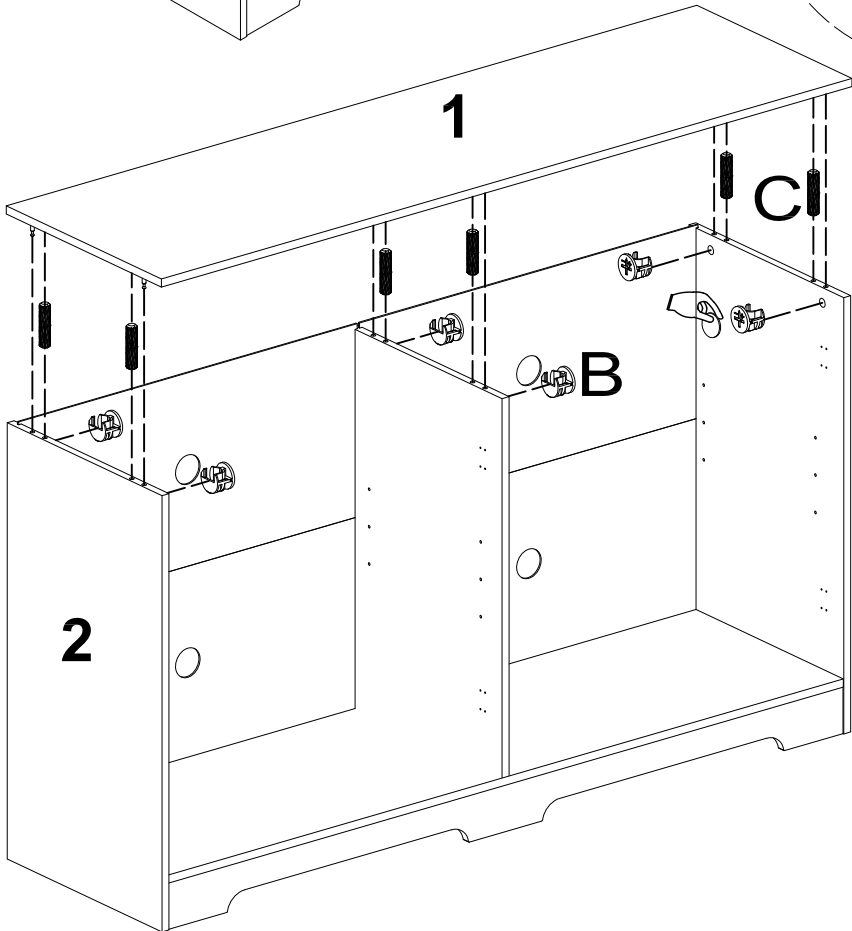

# ASSEMBLY INSTRUCTIONS

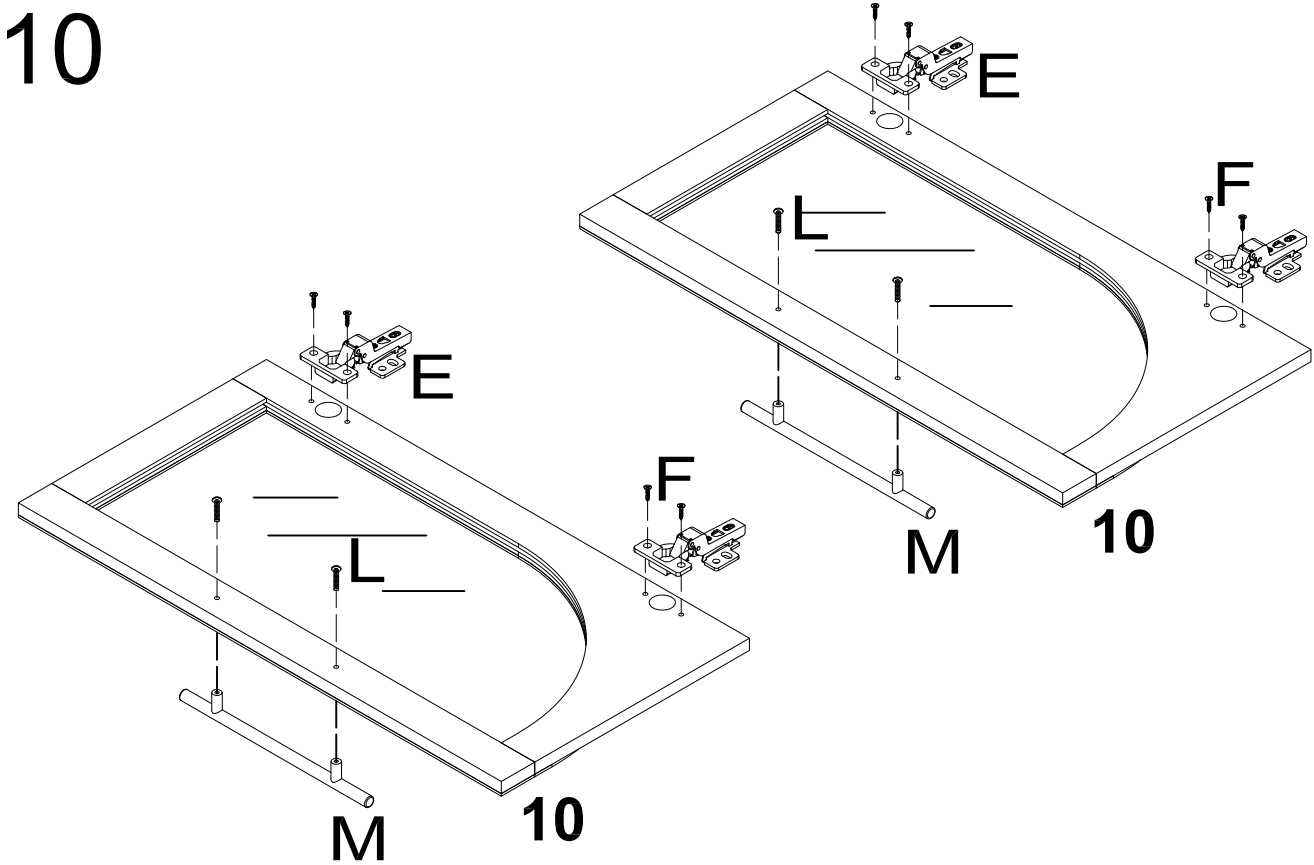
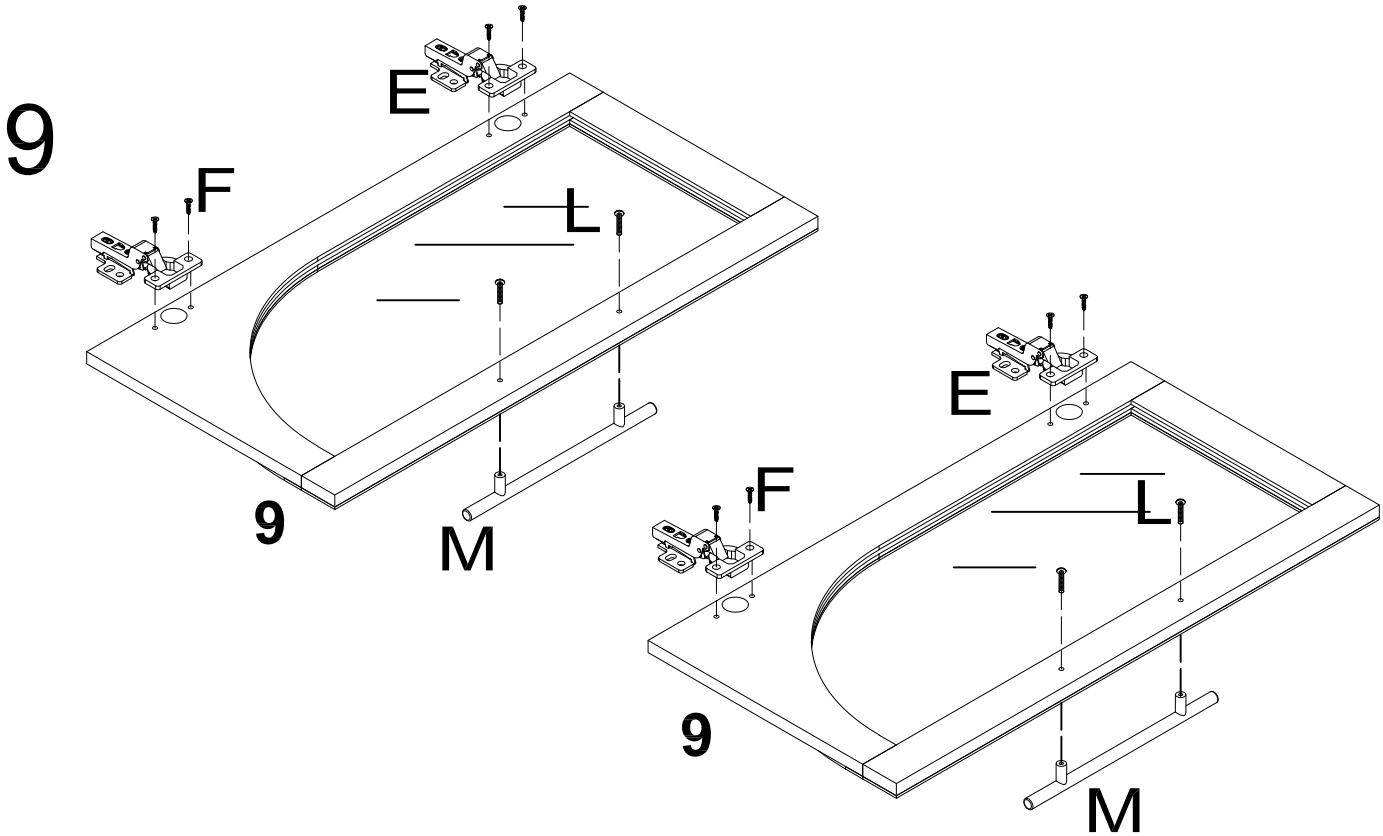

# ASSEMBLY INSTRUCTIONS

11

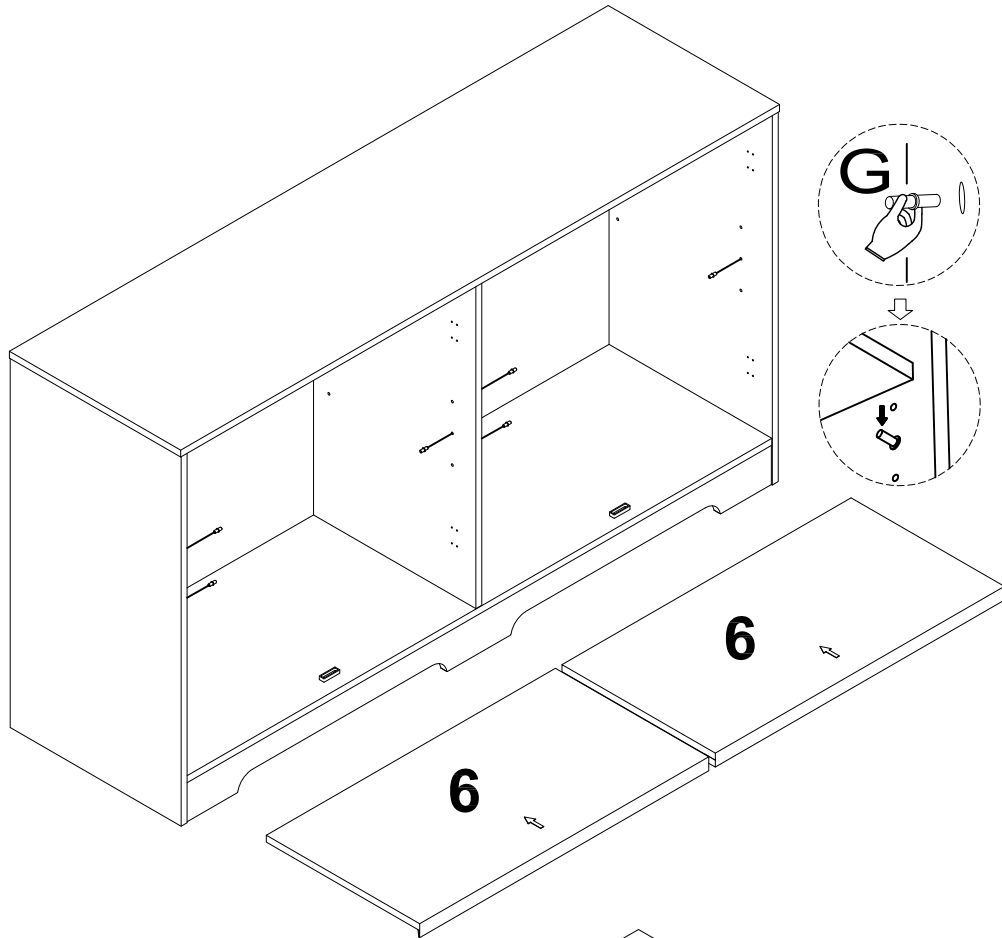

12

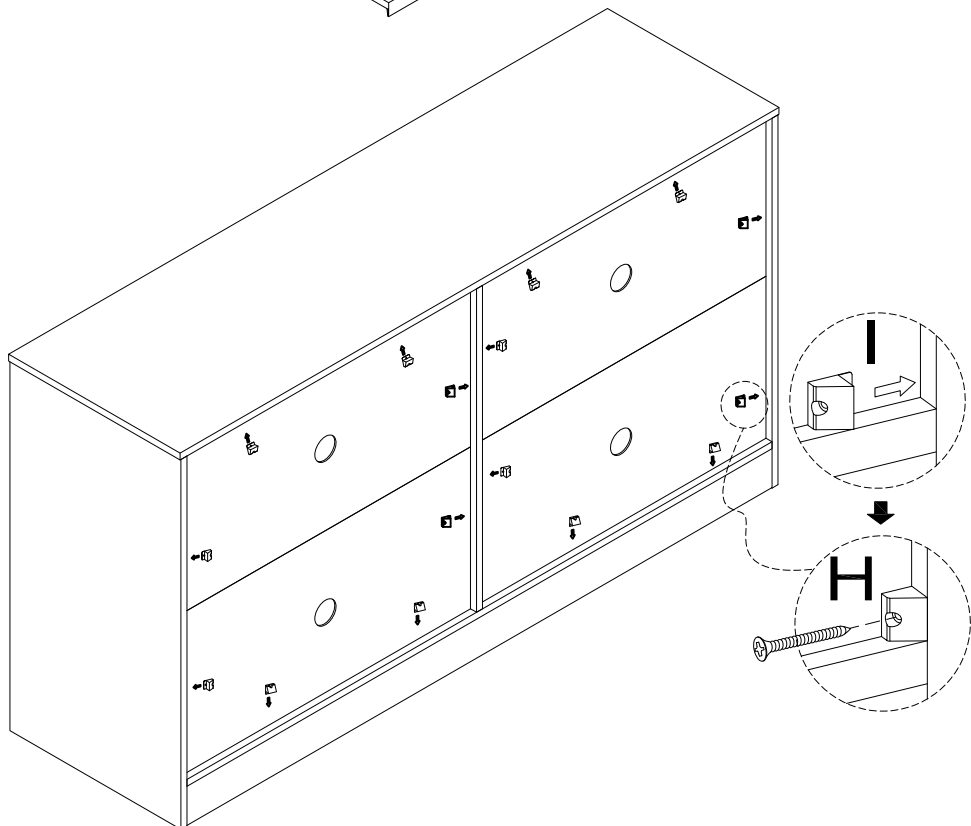

# ASSEMBLY INSTRUCTIONS

# 13

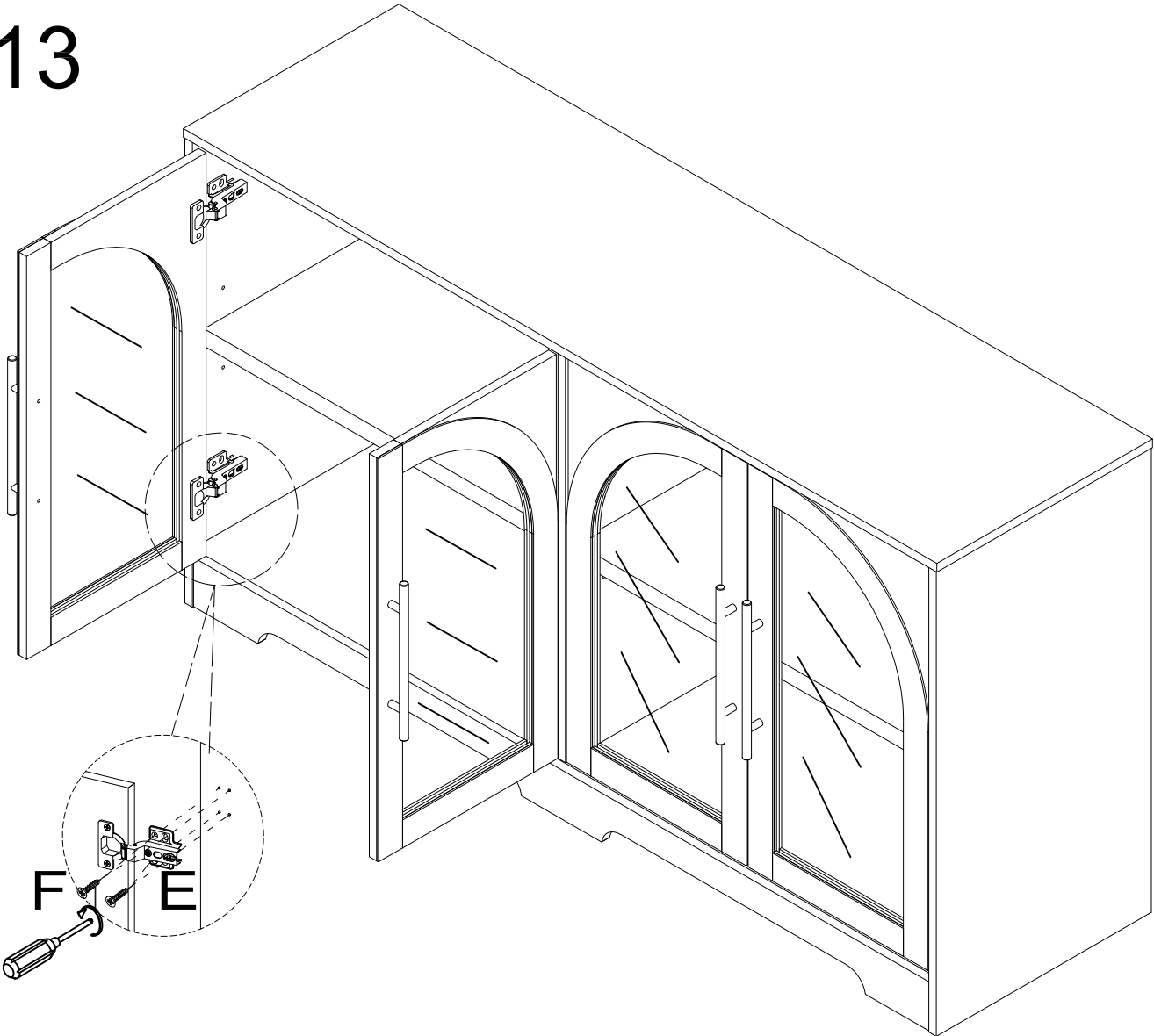

Concealed hinges are three-way adjustable.

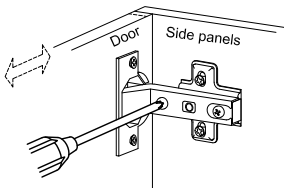

Horizontal  
by screw adjustment

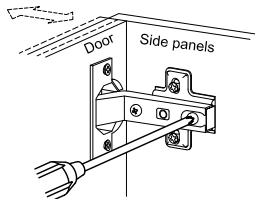

In-and-Out  
by loosening the hinge-arm  
mounting screw or via cam  
adjustment

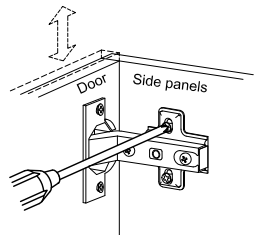

Vertical  
Via slots in the mounting  
plate or via cam adjustment

# ASSEMBLY INSTRUCTIONS

# 14

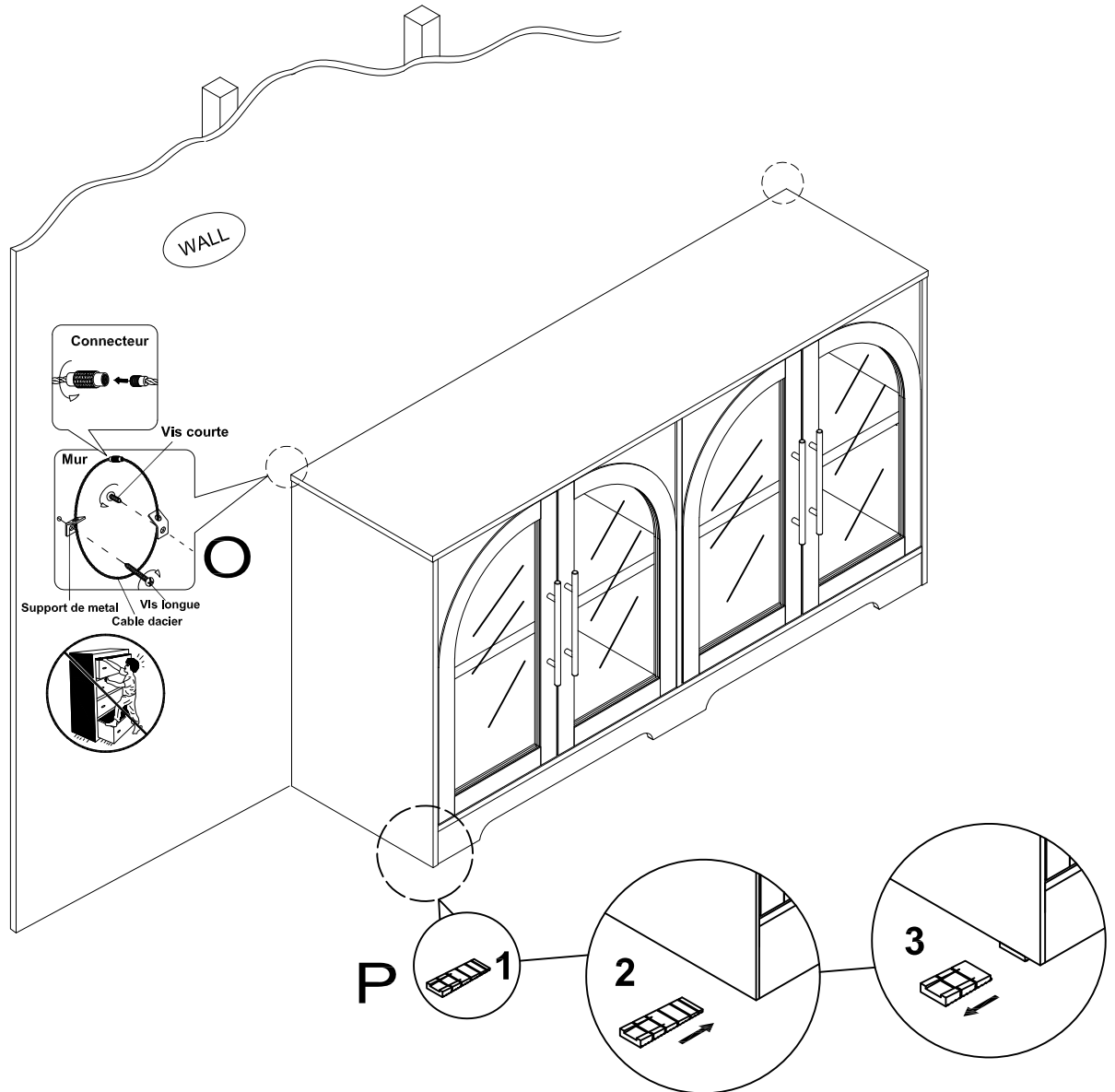

NOTE: IF THE UNIT IS PLACED ON AN UNLEVEL SURFACE, PLACE A LEVELER UNDERNEATH ONE FOOT UNTIL THE UNIT IS LEVEL. BREAK OFF ANY PROTRUDING SEGMENTS.

NOTA: EN CASO DE QUE EL DISPOSITIVO ESTÉ COLOCADO SOBRE UNA SUPERFICIE DESNIVELADA, PONGA UN NIVELADOR POR DEBAJO DE UNA PATA DE DISPOSITIVO HASTA QUE EL CUAL ESTÉ NIVELADO. ROMPA CUALQUIERA DE LOS SEGMENTOS QUE SOBRESALEN.

REMARQUE: SI L'UNITE EST PLACEE SUR UNE SURFACE DE NON-NIVEAU, PLACEZ UN NIVELEUR SUR UNE PIE JUSQUE'A CETTE UNITE EST PLACEE, ROMPREZ TOUT SEGMENTS SAILLANTS.

提醒: 如果产品无法放水平, 请在某一条腿下放置楔形脚垫。待家具放置水平之后, 敲掉多余的部分

### ! WARNING !

The use of the included tipping restraint may reduce, but not eliminate, the risk of furniture tip over. Follow the instructions on the plastic bag for proper installation.

### ¡ADVERTENCIA!

El uso del dispositivo diseñado para evitar que el mueble se dé vuelta reduce pero no elimina el riesgo de que eso pueda suceder. Siga las instrucciones que hay en la bolsa plástica para la instalación adecuada.

### ! AVERTISSEMENT !

L'utilisation du système anti-bascule peut réduire, mais n'élimine pas, les risques de renversement du meuble. Suivez les instructions se trouvant sur le sac en plastique pour l'installer correctement.

### ! 敬告 !

使用防倾装置只能降低但不能完全避免倾倒风险, 安装此装置时请按照包装袋上的说明。

# ASSEMBLY INSTRUCTIONS

# 15

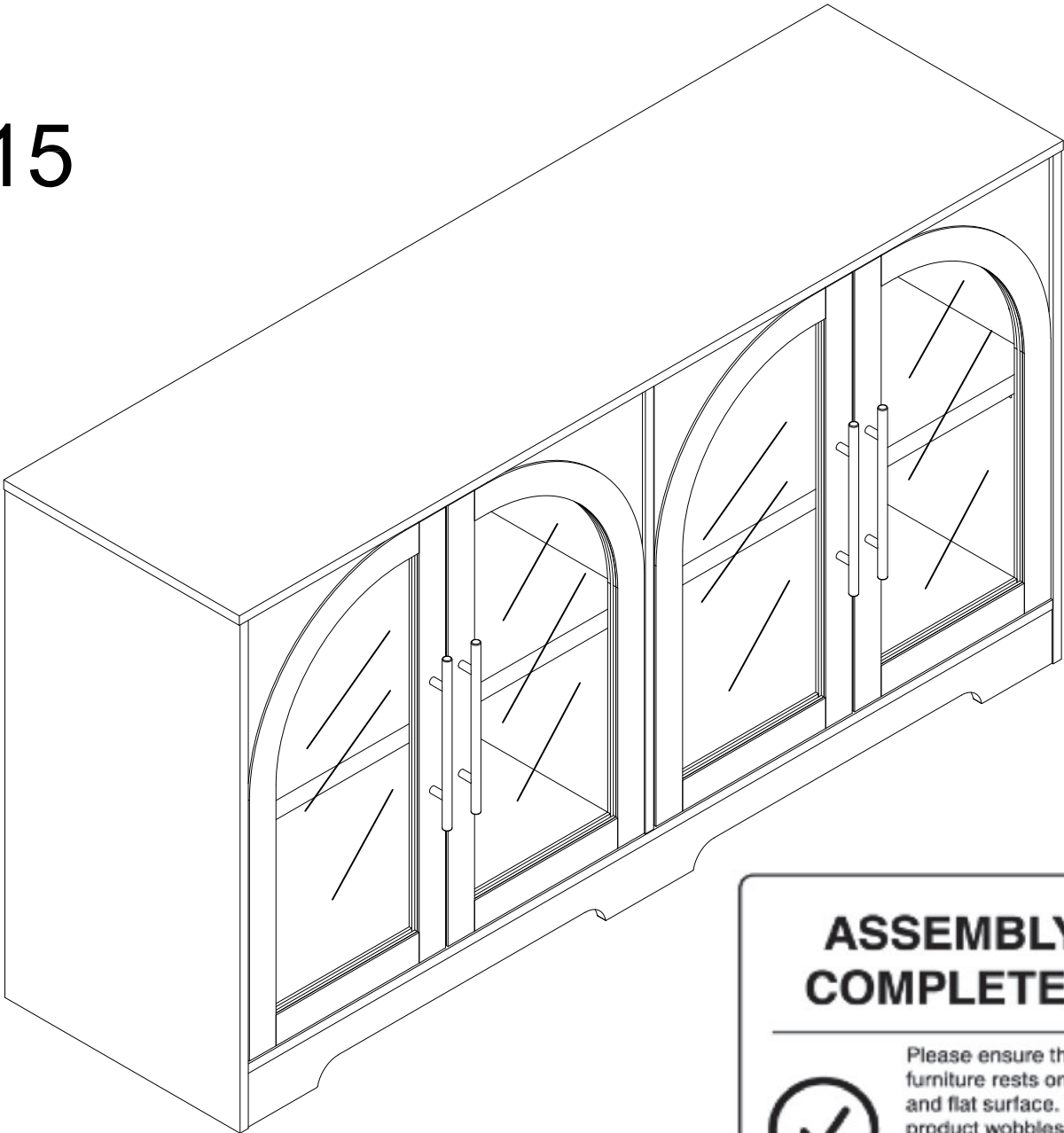

## ASSEMBLY COMPLETED



Please ensure the furniture rests on an even and flat surface. If the product wobbles or feels loose, double-check all bolts and/or screws are properly tightened and secured.



### Keep this handy!

Please retain this instruction manual and any order-related information for future reference.



### Lift, don't drag!

To avoid damage to product please always LIFT the product when transporting or adjusting the placement.

This product is intended for RESIDENTIAL USE ONLY and not for commercial use.