

80125-311/321/331/341/511/521/531/541 ASSEMBLY INSTRUCTION

Thank you for purchasing this quality product. Be sure to check all packing material carefully for small parts which may have come loose inside the carton during shipment. Separate, identify and count all parts and hardware. Compare with the parts list to be sure all parts are present.

IMPORTANT : PLEASE READ INSTRUCTION BEFORE STARTING THE ASSEMBLY.

"DO NOT TIGHTEN SCREWS UNTIL COMPLETELY ASSEMBLED"

"DO NOT OVERTIGHT ANY HARDWARE"

WARNING : SMALL PARTS AND HARDWARE NOT FOR CHILDREN UNDER 3 YEARS. ADULT ASSEMBLY REQUIRED.

TABLE OF CONTENTS

HARDWARES LIST	PAGE 2
PARTS LIST	PAGE 3 - 4
PARTS' LOCATION	PAGE 5
ASSEMBLY STEPS	PAGE 6 - 9
ASSEMBLY COMPLETED	PAGE 10

ASSEMBLY TOOLS REQUIRED

1. Screwdriver (not provide)



2. Hammer (not provide)









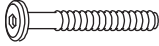

Skip the power drill this time.

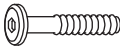





80125-311/321/331/341/511/521/531/541 ASSEMBLY INSTRUCTION

HARDWARES LIST

ITEM	DESCRIPTION	DRAWING	QTY
A	JCBC SCREW M8 x 50MM		4 PCS
B	JCBC SCREW M6 x 15MM		20 PCS
C	JCBC SCREW M6 x 20MM		8 PCS
D	SPRING WASHER M8 x 13MM		4 PCS
E	FLAT WASHER M8 x 22MM		4 PCS
F	M4 ALLEN KEY (100MM)		1 PC
G	M5 ALLEN KEY (65MM)		1 PC
H	SUPPORT LEG ADJUSTABLE FEET		4 PCS

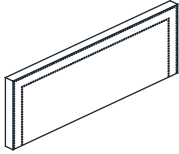
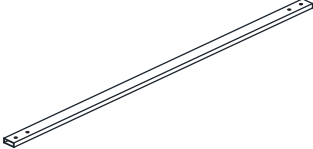
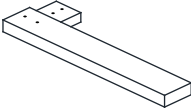
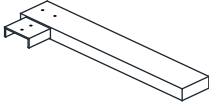
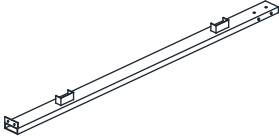
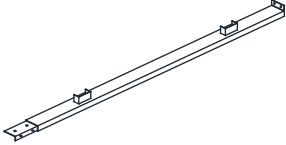
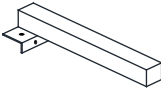
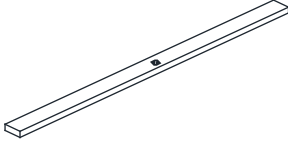
80125-311/321/331/341/511/521/531/541 ASSEMBLY INSTRUCTION

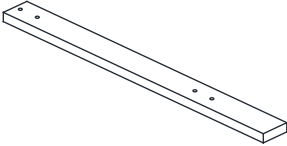

PARTS LIST

ITEM	DESCRIPTION	DRAWING	QTY
1	HEADBOARD		1 PC
2	FOOTBOARD METAL TUBE		1 PC
3	FOOTBOARD LEG (L)		1 PC
4	FOOTBOARD LEG (R)		1 PC
5	SIDE RAIL		2 PCS
6	SIDE RAIL		2 PCS
7	SIDE RAIL LEG		2 PCS
8	SLAT WITH NUT		4 PCS
9	SUPPORT LEG WITH HANGER BOLT		4 PCS
10	HEADBOARD LEG		2PCS
11	SIDE RAIL COVER		2 PCS

MORE PARTS DETAIL IN NEXT PAGE...

80125-311/321/331/341/511/521/531/541 ASSEMBLY INSTRUCTION

PARTS LIST

ITEM	DESCRIPTION	DRAWING	QTY
12	FOOTBOARD COVER		1 PC
24	VELCRO TAPE		1 PC

PARTS ' LOCATION

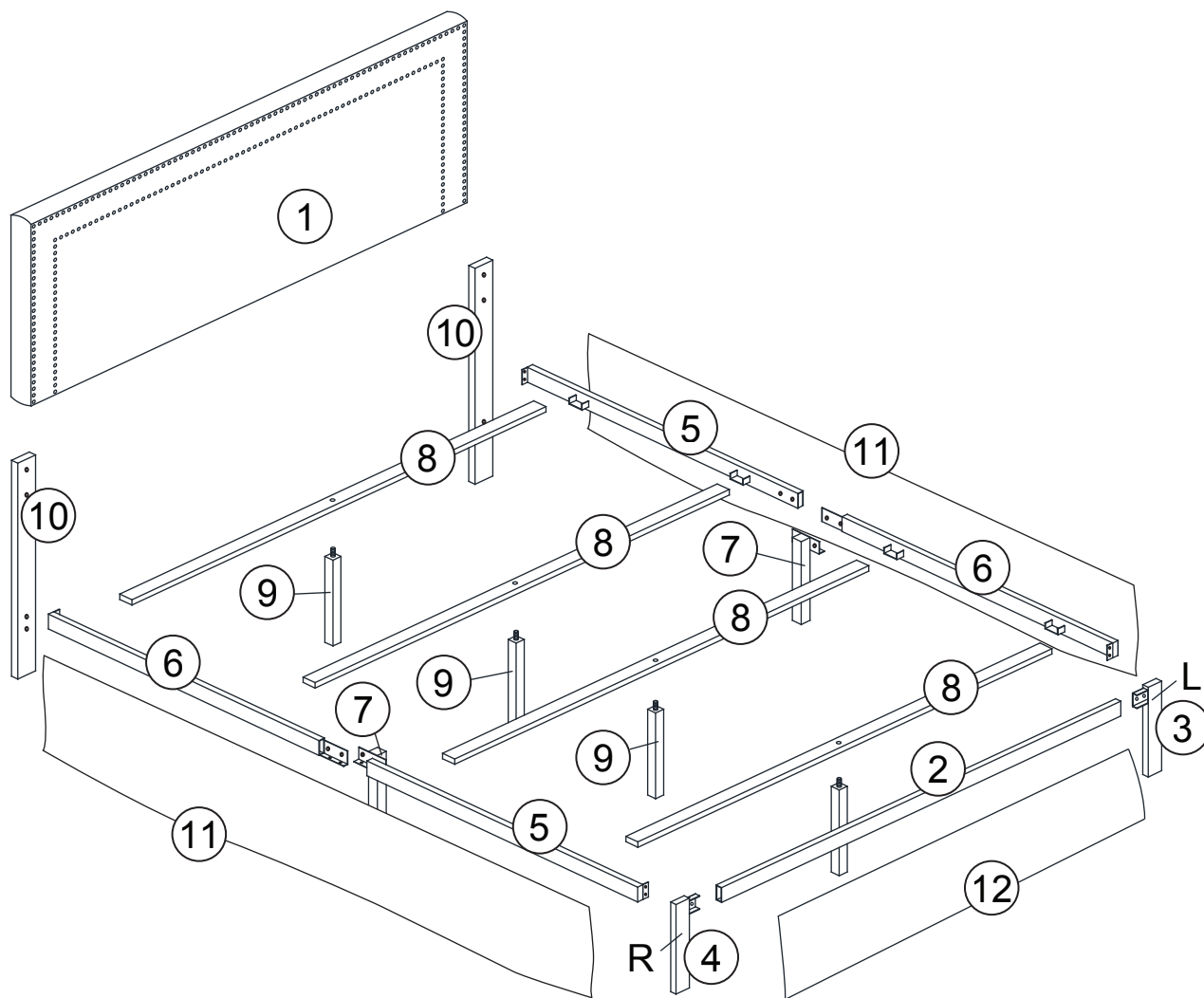

80125-311/321/331/341/511/521/531/541 ASSEMBLY INSTRUCTION

STEP 1

Open zipper to get all other parts.

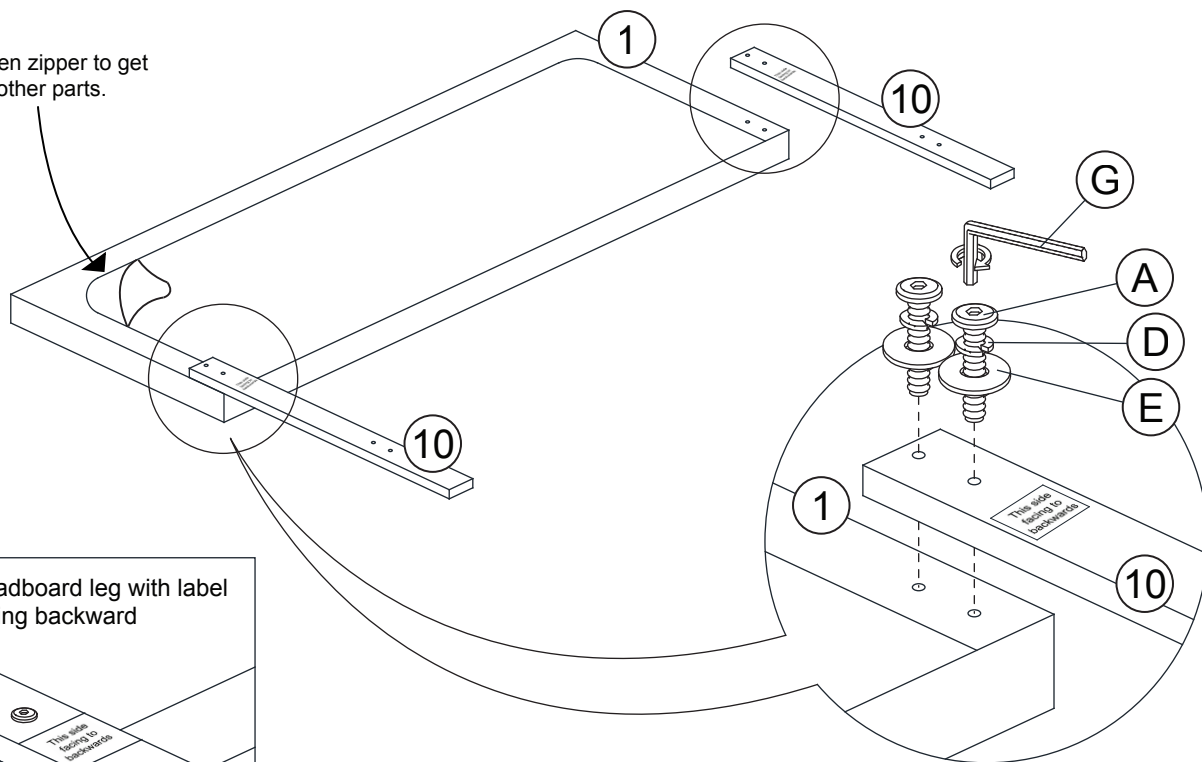

REMARK : Headboard leg with label facing backward

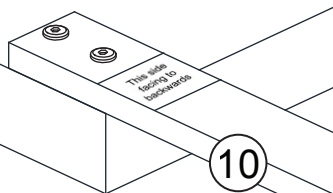

STEP 2

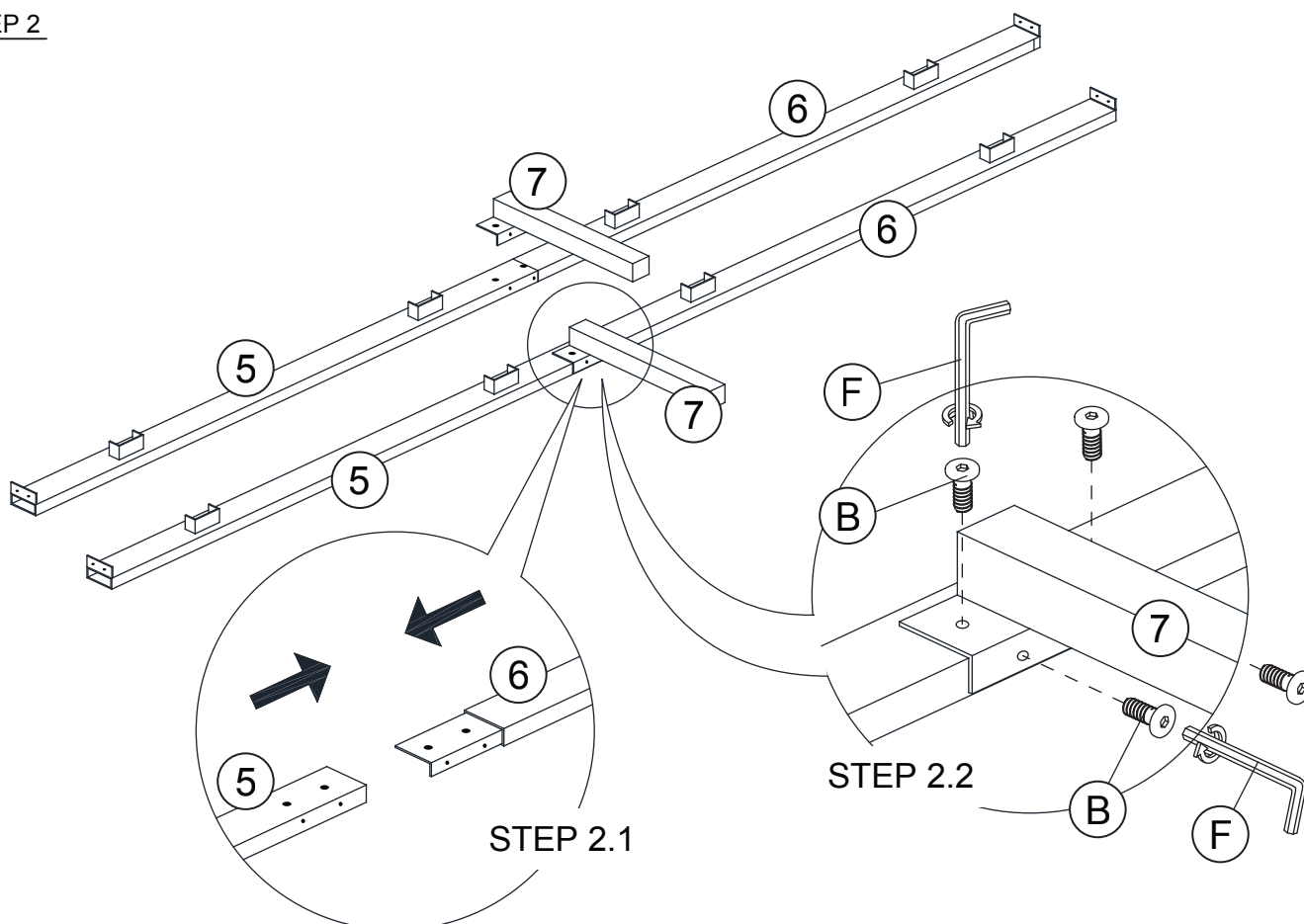

80125-311/321/331/341/511/521/531/541 ASSEMBLY INSTRUCTION

STEP 3

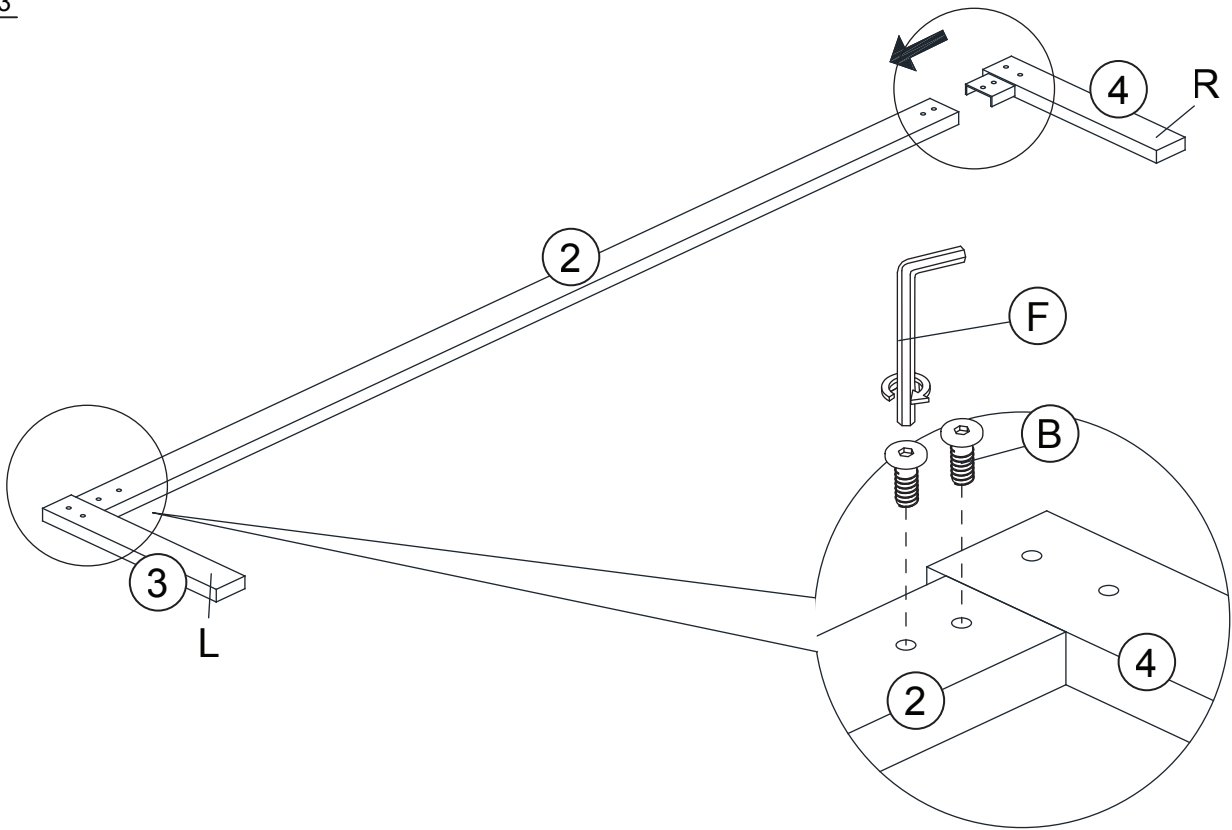

STEP 4

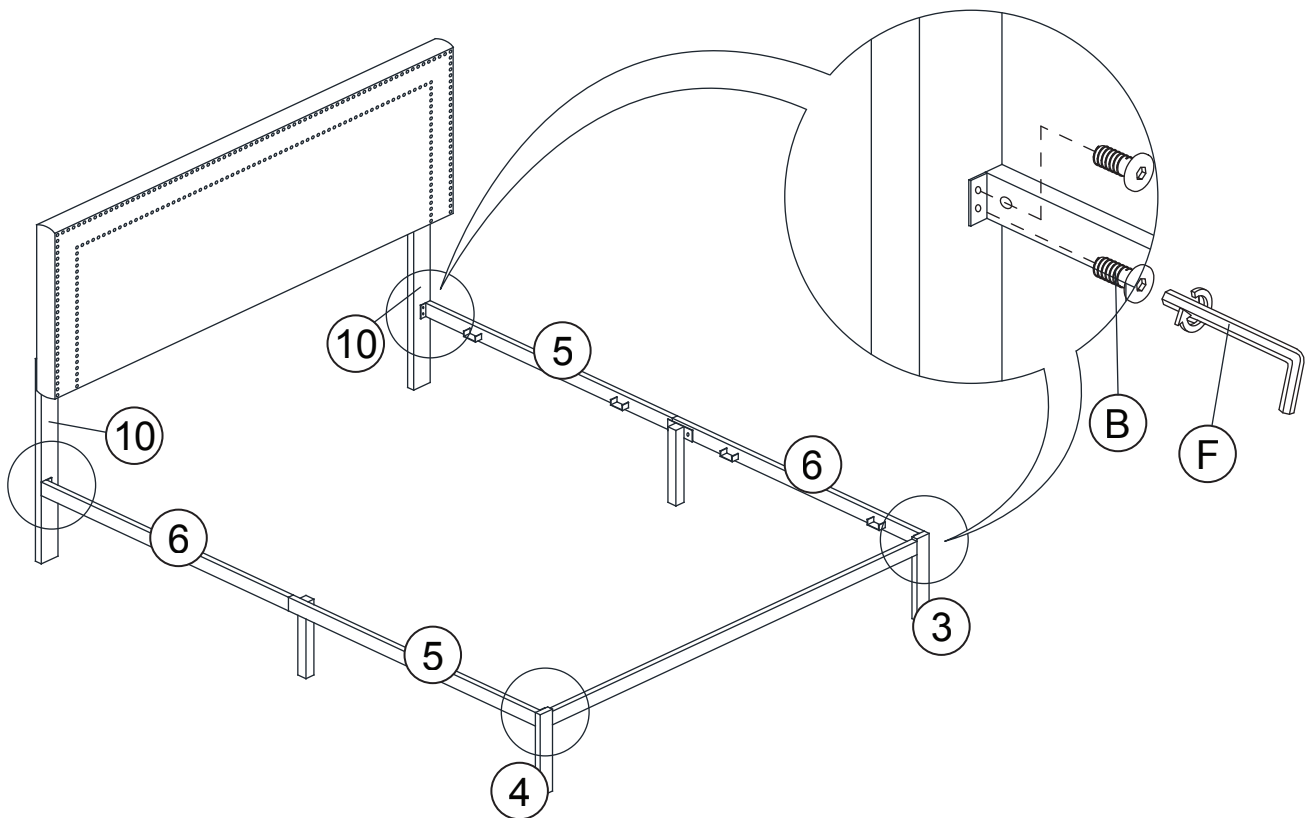

80125-311/321/331/341/511/521/531/541 ASSEMBLY INSTRUCTION

STEP 5

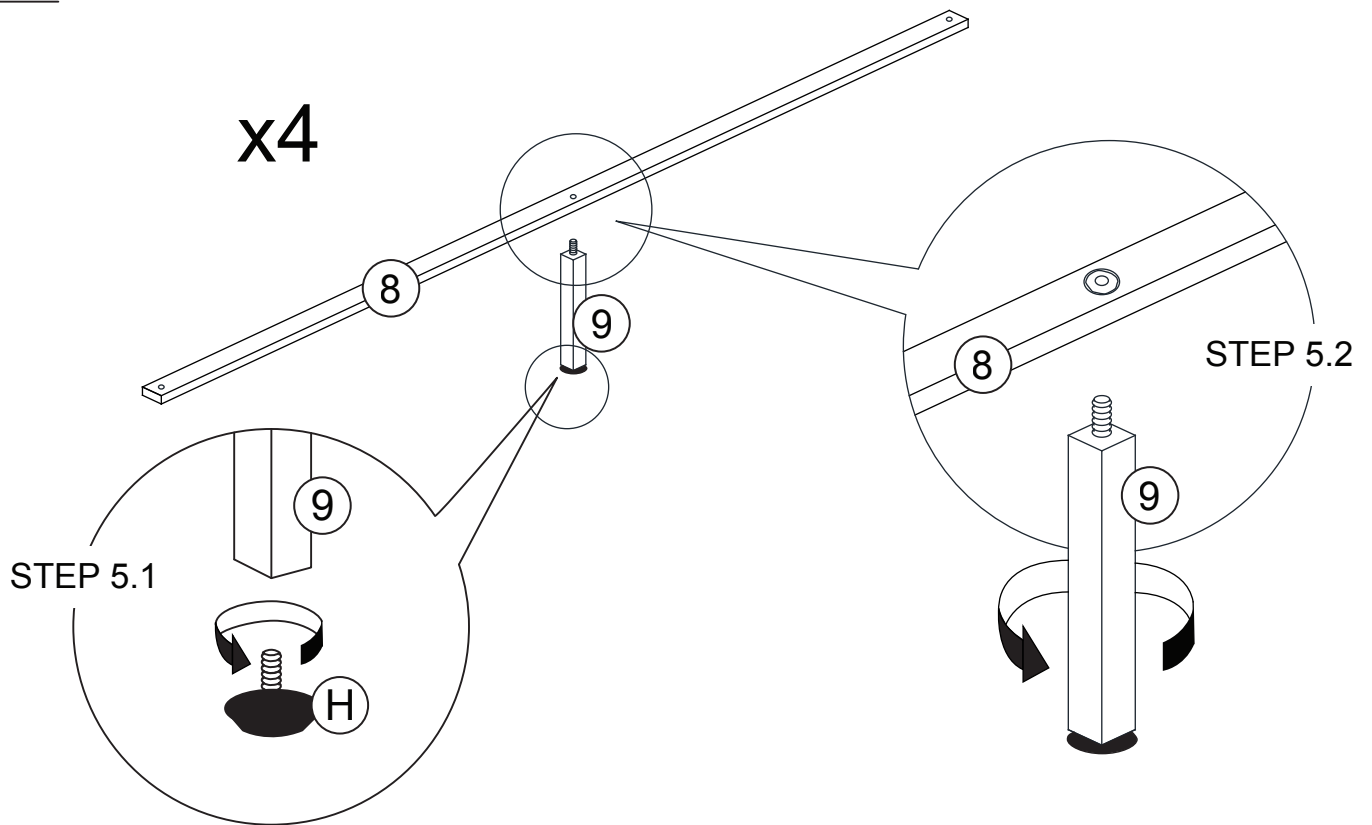

STEP 6

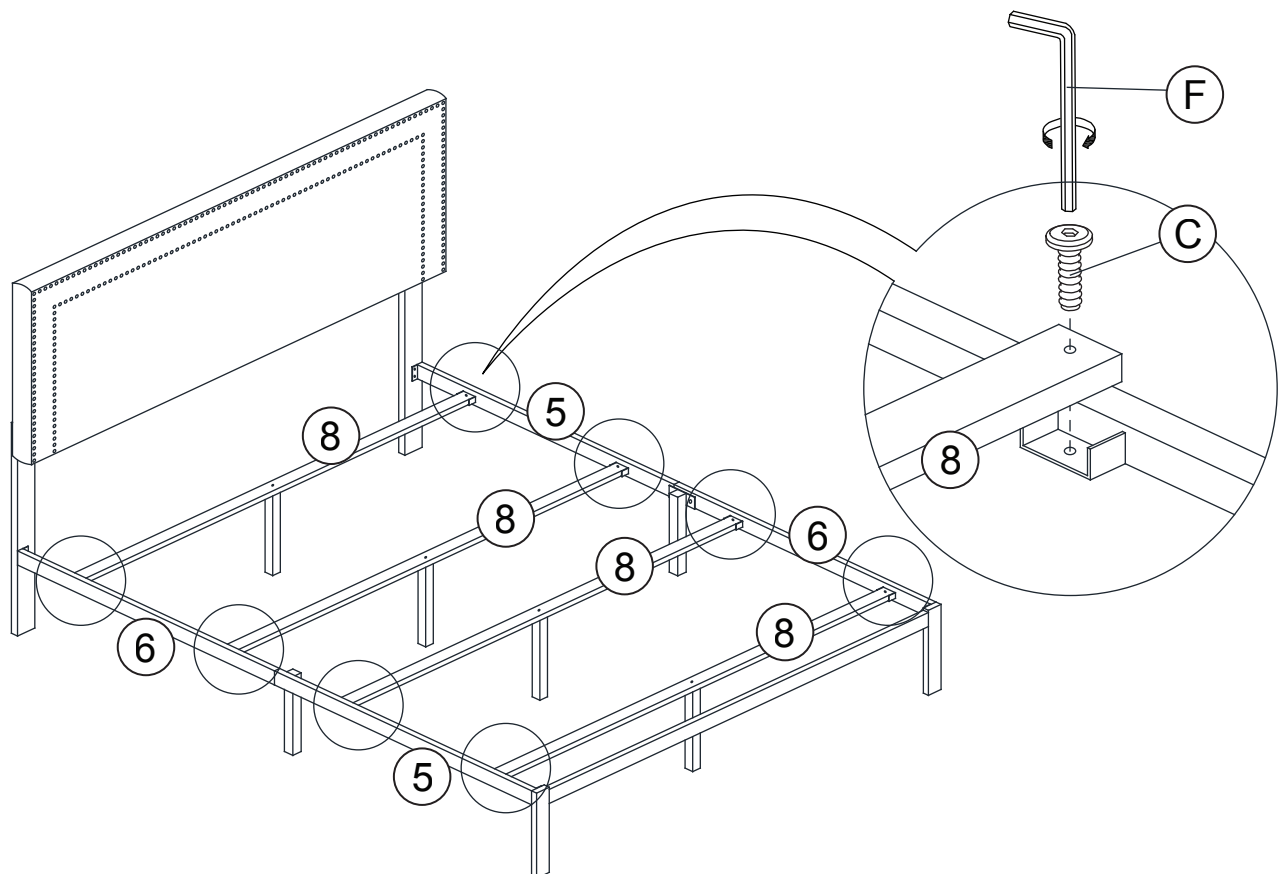

80125-311/321/331/341/511/521/531/541 ASSEMBLY INSTRUCTION

STEP 7

REMARK:
Clean the sticking part and keep it clean before sticking the velcro, to avoid affecting the stickiness.

REMARK:
Tear off the white isolation paper on the back of velcro hook

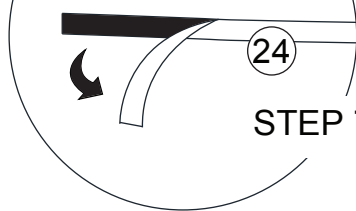

STEP 7.2

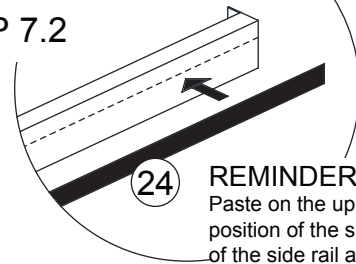

STEP 8

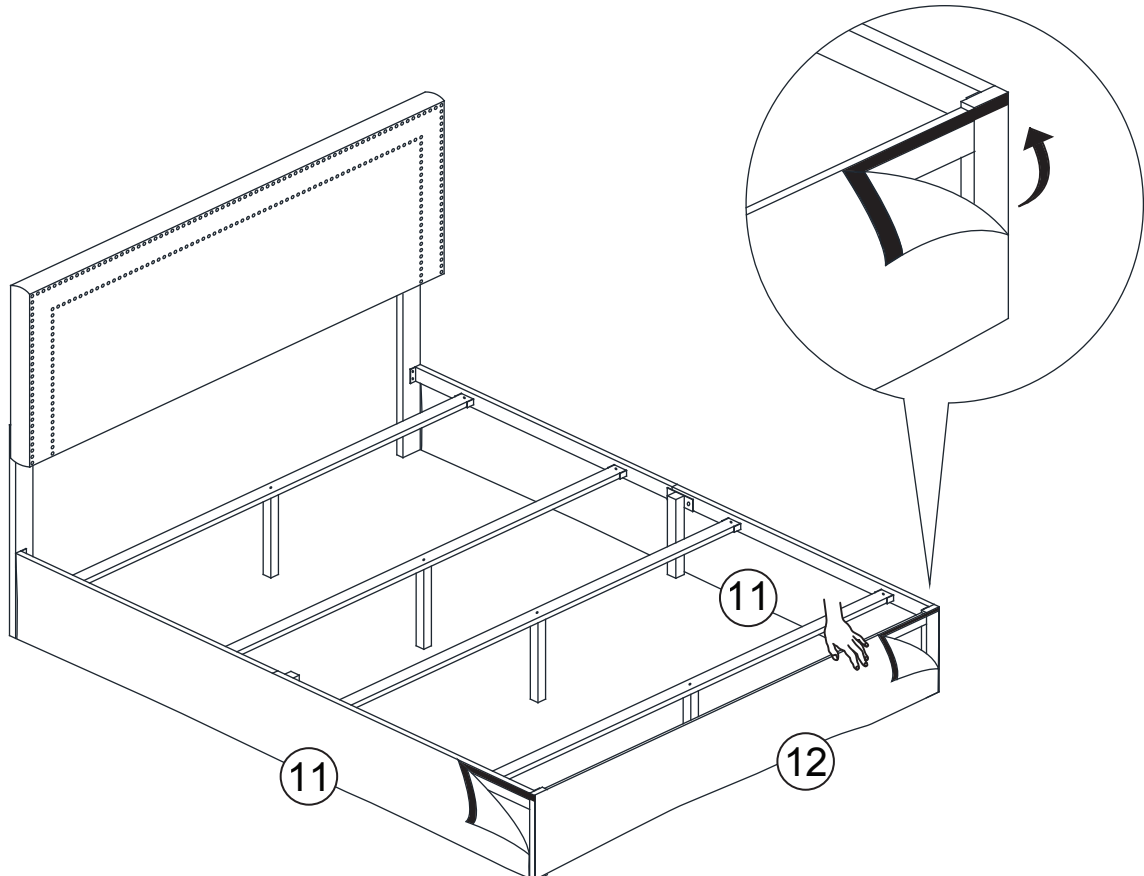

80125-311/321/331/341/511/521/531/541 ASSEMBLY INSTRUCTION

STEP 9

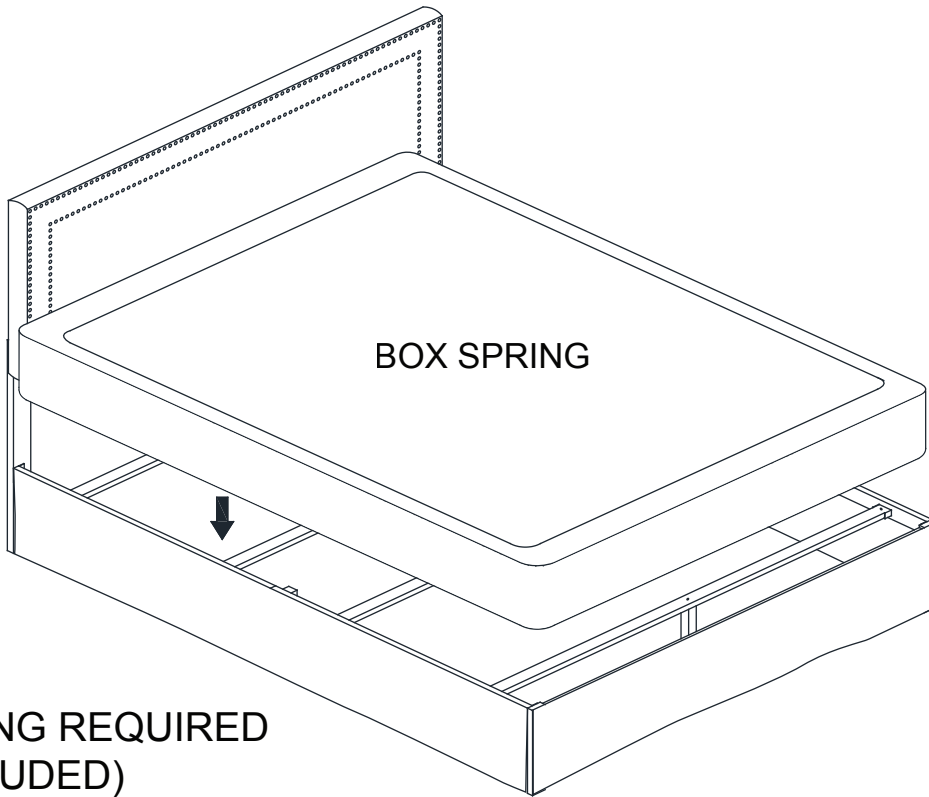

**BOX SPRING REQUIRED
(NOT INCLUDED)**

STEP 10

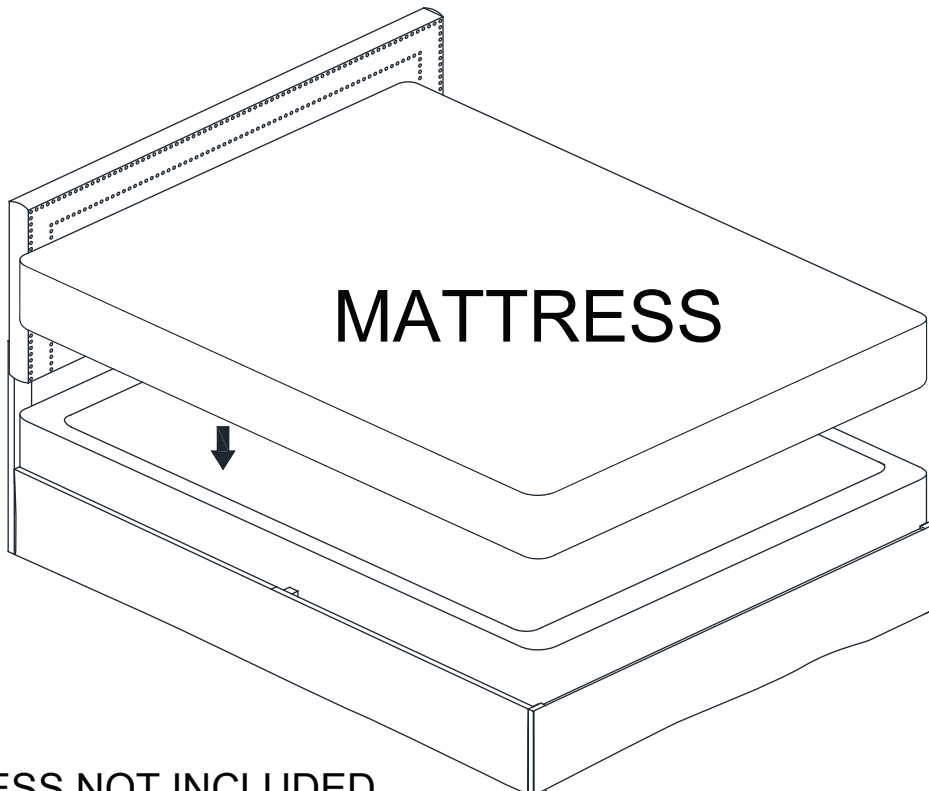

MATTRESS NOT INCLUDED

ASSEMBLY COMPLETED