



☎ 213 675 2021
✉ support@trendytotesinc.com
📍 162 Atlantic St, Pomona, CA 91768

INSTALLATION MANUAL

DELUXE ONE-PIECE TOILET

✉ support@trendytotesinc.com
☎ 213 675 2021



PRODUCT
INSTRUCTION
VIDEO

N-BT-151R-OPT



THANK YOU!

Dear Valued Customer,

Thanks to your kind support of NTQ, we hope our product can improve the quality of your life.

As our valued customer, your comments and opinions are very important to us. If you have any concerns, questions, or comments, we hope that you will bring them to our attention.

Please keep the carton and packaging materials until your product is completely installed.

Feel free to contact us if you encounter any problems such as missing parts, or product defects during the installation process. We are happy to provide you with the most sincere service.



*Sincerely,
NTQ Service Team*



READ ALL INSTRUCTIONS BEFORE UNPACKING THE PRODUCT



INSTRUCTIONS THAT, IF IGNORED, COULD RESULT IN DEATH OR SERIOUS INJURY CAUSED BY INCORRECT HANDLING OR INSTALLATION OF THE PRODUCT. THESE INSTRUCTIONS MUST BE OBSERVED FOR SAFE INSTALLATION.

ATTENTION !



2 PEOPLE ARE REQUIRED TO LIFT AND DURING ENTIRE INSTALLATION OF THIS PRODUCT



INSTALLATION OF THIS PRODUCT BY AN INEXPERIENCED INSTALLER MAY RESULT IN PERSONAL INJURY OR DEATH!



We reserves the right to change, update, modify, alter, redesign this manual/product or its policies without prior notice!
It is your responsibility to visit the website to download or contact customer service for the most updated version of the installation instructions
We shall not be liable for any injuries or property damages in connection with this product during installation or use of this product!

- Limited warranty is void on any commercial installation.
- We are not responsible for local code compliance for this product.
- Building and plumbing codes may vary from state-to-state in accordance to your location.
- We are not responsible for providing any compliance certifications.
- We are not responsible to provide any type of certifications for this product.
- Under no circumstances we shall not be liable for any and all incidental damages sustained in connection with this product Neither manufacture, nor distributor, nor retailer is responsible for water damage or flood caused due to use of this product.
- Under no circumstances We shall not be liable for any and all fees, cost of installation/re-installation/removal, subsequent damage or transportation in case of the product defect.

TOOLS REQUIRED FOR INSTALLATION

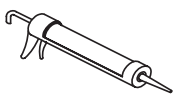

Silicone

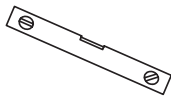

Level

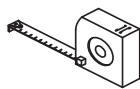

Tape Measure



Socket extension



Safety Glass

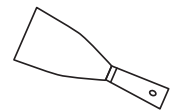

Putty Knife

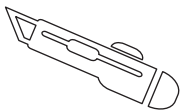

Knife



Soft Cloth

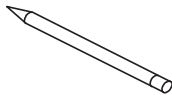

Pencil / Marker

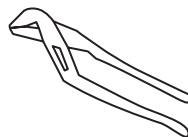

Channel Pliers



Wrench

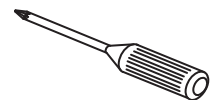

Wrench

N-BT-151R-OPT

1 Parts

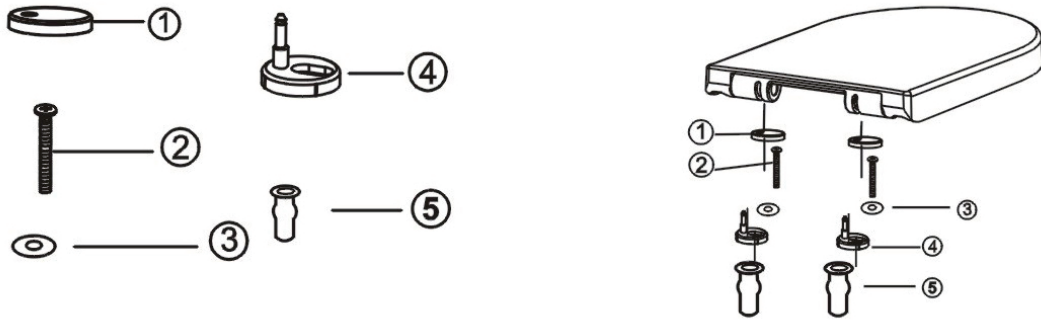

NO.	Description	Qty
1.	Stainless Steel Hinge cap	2
2.	Bolt	2
3.	Washer	2
4.	Hinge Base	2
5.	Rubber Cork	2

2 Installation Guide

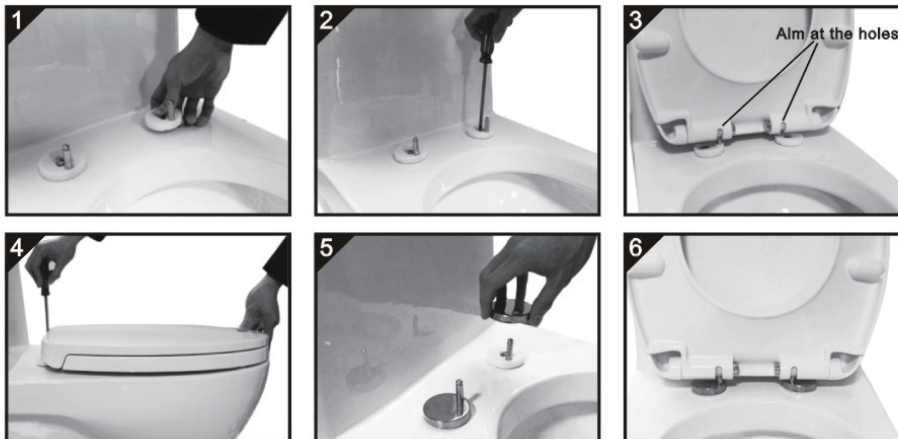

1. Insert the screw set on the hinge base through the holes on the pan.
2. Tighten the seat screws, but not fully allowing you movement to adjust the seat cover properly
3. Aim at the holes and adjust the hinge base to make the seat cover and pan match. Take out the seat cover once the installation position is confirmed.
4. Fix the hinge base on the pan firmly.
5. Put the cap into the hinge base.
6. Fix the seat cover into the hinge base.

Care Instructions :











Please read carefully the following maintenance manual in order to avoid component damage or injury to the installer.

Keep the maintenance manual available for future maintenance or reference.

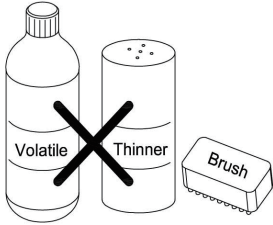

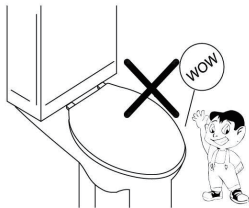
PRECAUTIONS: Follow all safety precautions to avoid personal injury or property damage.

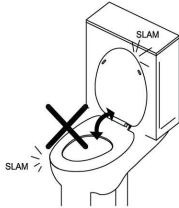
⊘ "Prohibited acts"

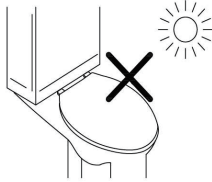
 PRECAUTIONS		<p>1. Do not open/close the seat cover using unnecessary force. (It might cause cracks or failure on performance)</p> <p>2. Heavy loading may damage the seat cover and may cause a fall.</p>	
		<p>3. Do not use strong abrasive cleansers, which might cause damage to the surface</p> <p>4. Clean the surface of the toilet seat with mild soap water.</p> <p>5. Use a clean and soft cloth to wipe the toilet seat until it is completely dry</p>	
		<p>6. Keep children out of reach of the seat, to avoid personal injury.</p>	
		<p>7. Do not open/close the seat cover using unnecessary force. (It might cause cracks or failure on performance)</p>	
		<p>8. Do not expose the seat cover directly to sunlight. (It might cause color fading)</p>	

TOILET INSTALLATION

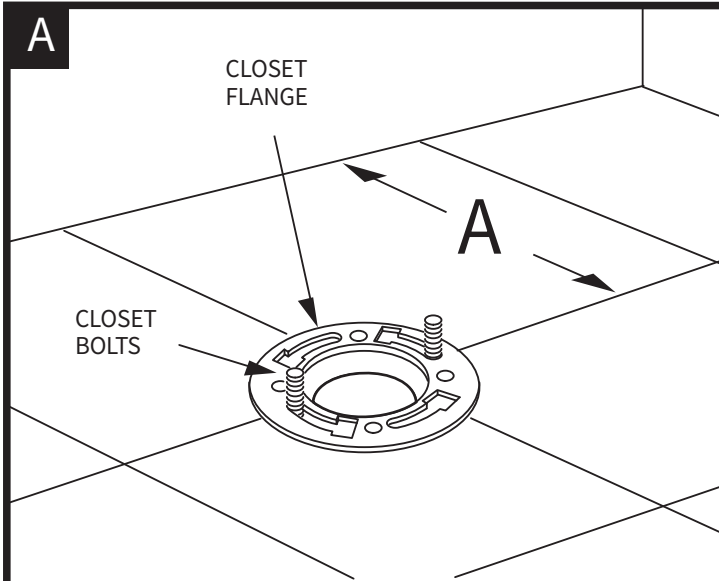

INSTALL CLOSET BOLTS

Install closet bolts in flange channel, turn 90°, and slide into place 6" apart and parallel to wall.

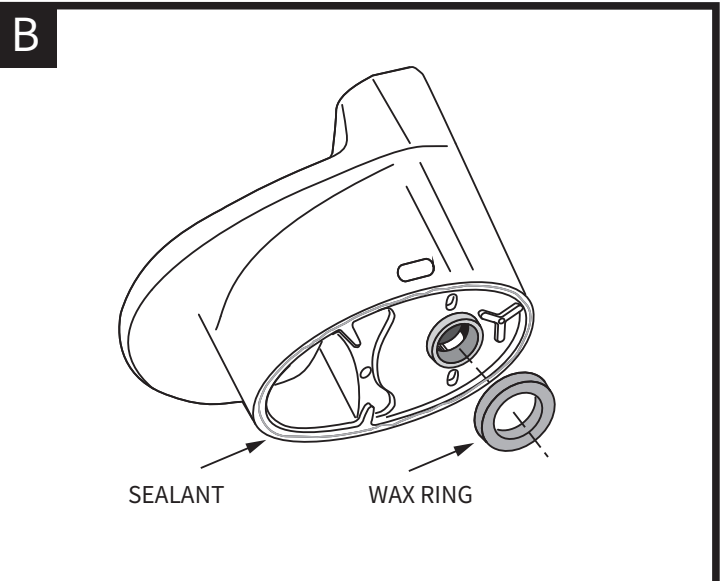

INSTALL WAX SEAL

Invert toilet on floor (cushion to prevent damage), and install wax ring evenly around waste flange (horn), with tapered end of ring facing toilet. Apply a thin bead of sealant around toilet base.

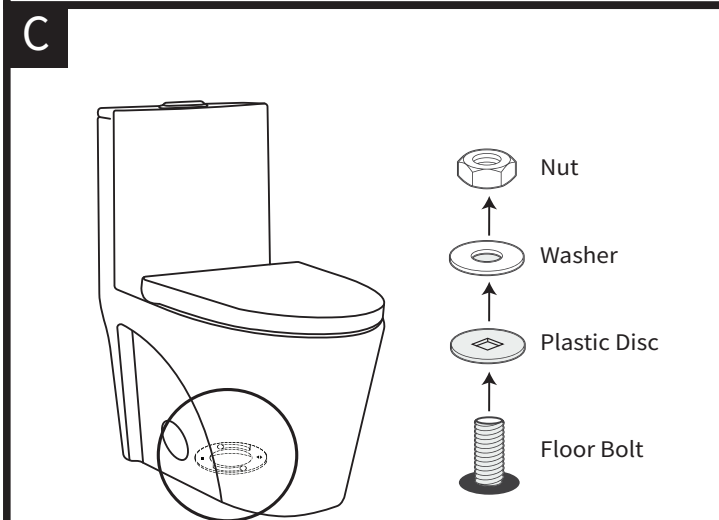

POSITION TOILET ON FLANGE

*Unplug floor waste opening and install toilet on closet flange so bolts project through mounting holes.

*Loosely install retainer washers and nuts.

*Position toilet squarely to wall and, with a rocking motion, press bowl down fully on wax ring and flange. Alternately tighten nuts until toilet is firmly seated on floor.

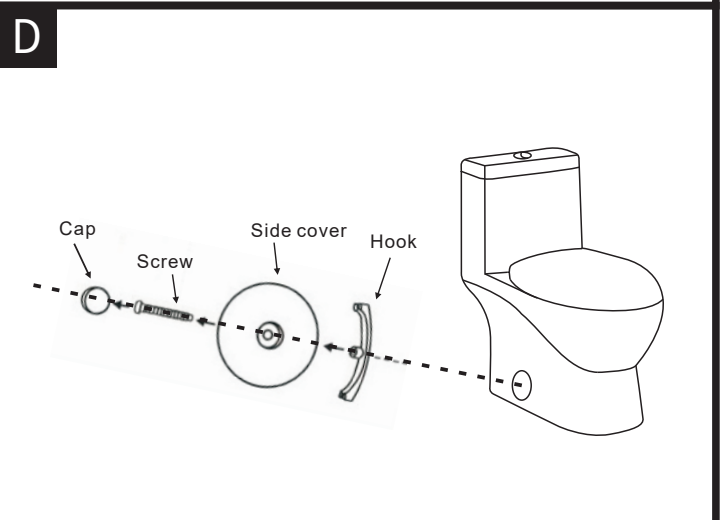

INSTALL THE SIDE COVER

*Adhere the side bolt covers to toilet.

THREE YEAR LIMITED WARRANTY

LIMITED WARRANTY COVERAGE

3 YEAR LIMITED WARRANTY

NTQ products are made with quality materials and excellent craftsmanship to provide the customers a long-lasting product. In the case of any defects in materials or craftsmanship under regular use were inspected in the first one year of delivery, NTQ will provide replacement parts at no charge, or at its option, replace any product or part of the product that is deemed defective, under normal installation, use, service and maintenance. This warranty applies only to the original purchaser. Proof of purchase will be required in the case of a claim. SCRATCHES ARE NOT COVERED UNDER WARRANTY.

The manufacturer warrants this product to be free of manufacture defects during the above mentioned warranty time. Please keep a copy of the original invoice as proof of purchase.

NTQ will, as its option, (1) repair or replace the defective part(s) or product(s) at no charge; (2) issue a refund of the original purchase price of the product(s) (Valid within 30 days from the date of delivery); or (3) issue a credit to be applied toward the purchase of a new NTQ product shipping/delivery charges may apply and are in NTQ sole discretion.

OUR recommends the installations to be made by a licensed, professional plumber. NTQ will not be held responsible for any damage or product failure due to improper installation, misuse, or failure to use a licensed professional. OUR is not responsible for any removal or installation cost.

This limited warranty shall not apply to goods which have been subject to accident, negligence, improper installation, product abuse, product misuse, or use of cleaners containing abrasives, alcohol or other organic solvents, whether performed by a contractor, service company, or yourself, are excluded from this warranty.

NTQ responsibility under this limited warranty is limited to only to replacement parts and no other costs. NTQ will not be responsible for labor charges and/or damage incurred by installation, repair or replacement, nor for any indirect incidental or consequential damages, losses, injury or costs of any nature relating to this product Except as provided by law, this limited warranty is in lieu of and excludes all other warranties, conditions, and guarantees, whether expressed or implied, statutory or otherwise, including without restriction those merchantability of fitness for use.

RESPONSIBILITIES OF OTHERS

Inspecting the unit prior to installation is the responsibility of the installer or building contractor who acts on behalf of the user. They are responsible for ensuring the unit is free of defect or damage.

Notices are placed on and in the unit and on the shipping carton advising the installer of this responsibility.

In the event of a problem, the unit must not be installed. NTQ is not responsible for failures or damage that could have been discovered, repaired, or avoided by proper inspection and testing prior to installation.

Damage occurring in transit is the responsibility of the carrier. The user or installer MUST open the crate and inspect the unit for damage when it is delivered. If damage is discovered, it must be reported immediately to the seller and the carrier in writing, and an inspection requested. Failure of the carrier to respond should be reported to the seller and the carrier. Your freight claims should be filed promptly thereafter.

LIMITATIONS AND EXCLUSIONS

This warranty does not cover instances of negligence, misuse, abuse, improper installation, carelessness, accident, hard water or mineral deposits, exposure to corrosive materials, misapplication, damages caused by improper maintenance, alteration of the product, or failure to follow care or installation instructions enclosed with your product. This warranty is void if the NTQ is subject to alteration, or if repairs are attempted by anyone other than an authorized agent of NTQ. This warranty does not extend to plumbing or components installed by dealers, installers or by any party other NTQ.

NTQ will not be liable for loss of use of the NTQ inconvenience, or any other incidental or consequential costs, expense or damages. Please note that some states do not allow the exclusion or limitation of incidental damages.

DISCLAIMER

Except as expressly provided, there shall be no warranty or obligation, express or implied, oral or statutory. No dealer or other person has the authority to make any warranties or representations concerning NTQ or its products. In no event shall NTQ be held responsible for any such warranties or representations.

WARRANTY SERVICE

NOTE: When requesting warranty, be sure to have the following:

- Copy of original invoice
- Date of installation
- Description and pictures of defect
- Model number or description of model

To obtain warranty service and replacement part, please contact NTQ Customer Service. NTQ will determine whether to repair or replace your product, issue a refund, or issue a credit.

HOME SERVICES



INSTALLATION VIDEO

Missing Part or Defective?

Please Contact the Customer Service Team

 213 675 2021

 support@trendytotesinc.com