

Owner Manual



NOTICE

THE PILLOWS ARE FILLED WITH CUT SPONGE,
WHICH IS A PRODUCING TECHNIQUE.

WE PROMISE THAT ALL RAW MATERIALS
USED ARE BRAND NEW, SAFE TO USE,

AND IN ACCORDANCE WITH LAWS AND REGULATIONS,
WILL NOT EFFECT THE QUALITY AND SAFETY.

WE RECOMMEND ASK FOR PROFESSIONAL HELP IF NEEDED,
AND WE ALSO PROVIDE INSTALLATION VIDEO WITH THIS INSTRUCTIONS,
PLEASE CHECK THE STEPS CAREFULLY BEFORE YOU START.

IF YOU HAVE ANY QUESTIONS,
PLEASE FEEL FREE TO CONTACT US ANYTIME.

HAVE A GREAT DAY!



WARRANTY

We strive to offer high quality product and we also try our best to satisfy each customer that order from us, no matter on products or services as needed. Each customer receives a record of their order, such as the order number or item receipt. For any items that are out of warranty period, you may still be able to purchase the replacement parts from our company if they are available.

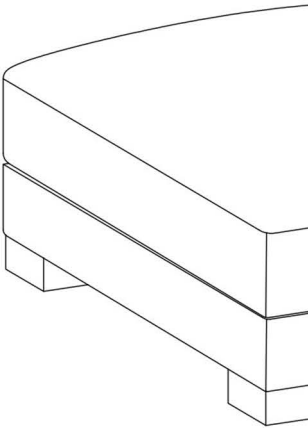

MAINTENANCE AND WARNING

Please read the manual thoroughly
before you start installing.

Please keep the product away from
sharp object.

Packaging and small parts may have
chocking hazard, please keep them away
from children and pets.

Please clean the product according to each
clean code, check the product description
for more information.

Please keep the product away from
fire.

If you have any other questions, please
contact us, we will be glad to help you out.

If the product is placed under direct
sunlight, the pattern or color might fade
away overtime.

Check the product periodically to make
sure everything is secured and tightened.

Always use proper tools for installation.

Do not jump on the product.

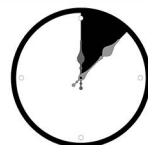

Around 15 min

PRODUCT DESCRIPTION

Corduroy Upholstery: Soft-touch corduroy with pronounced texture enhances comfort while offering excellent resistance to wear and tear.

Solid Wood Frame: Built on a robust solid wood structure that ensures reliable stability over time.

Foam and Spring and Fiber Filling: High-density foam, synthetic fiber, and spring pack layers deliver balanced support and responsive comfort.

Natural Wood Legs: Crafted from solid wood, the ottoman legs add a grounded, rustic element and high weight-bearing strength.

Multi-Functional Use: Whether placed in front of your sofa or used as an extra seat, this ottoman adapts effortlessly to modern lifestyles.

EXPLODED VIEW

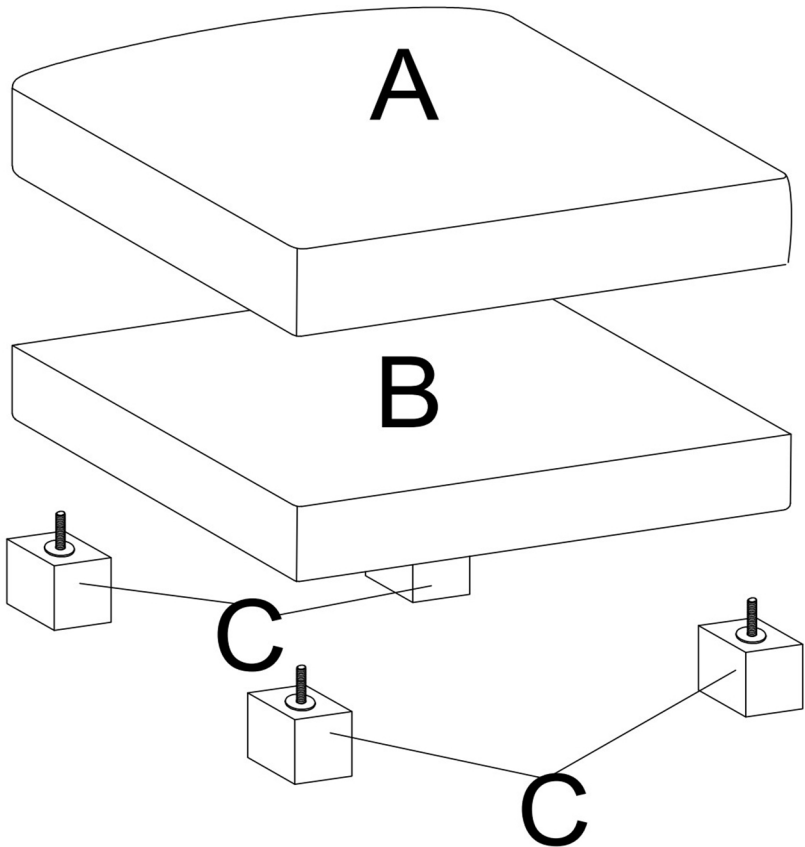

PARTS

A*1

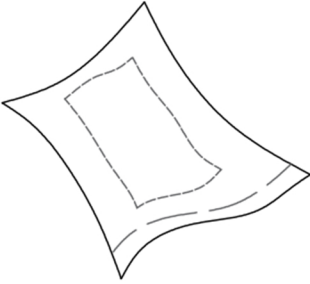

Seat cushion

B*1

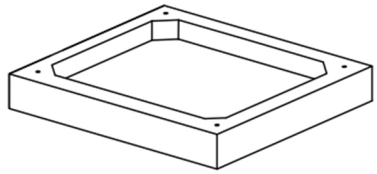

Seat frame

C*4



Legs

D*1

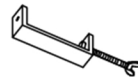

Hook

step 1

After taking out of the cushions (A) from the air compression bag, please allow it to recover for a period of time. It might take up to 48 hours to be fully recovered, you may gently slap onto the cushion to speed up the process.

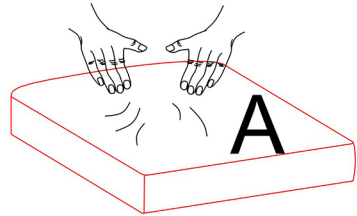
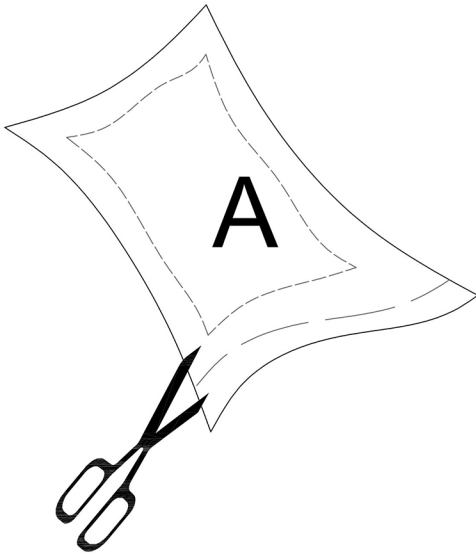
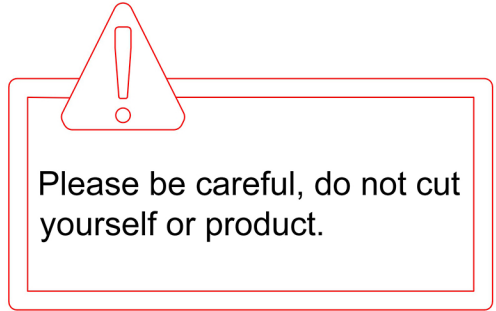

step 2

Remove the plastic caps from the bolt parts of the wooden legs. Screw all four legs (C) into holes on each corner of ottoman frame (B), tighten them with hands.

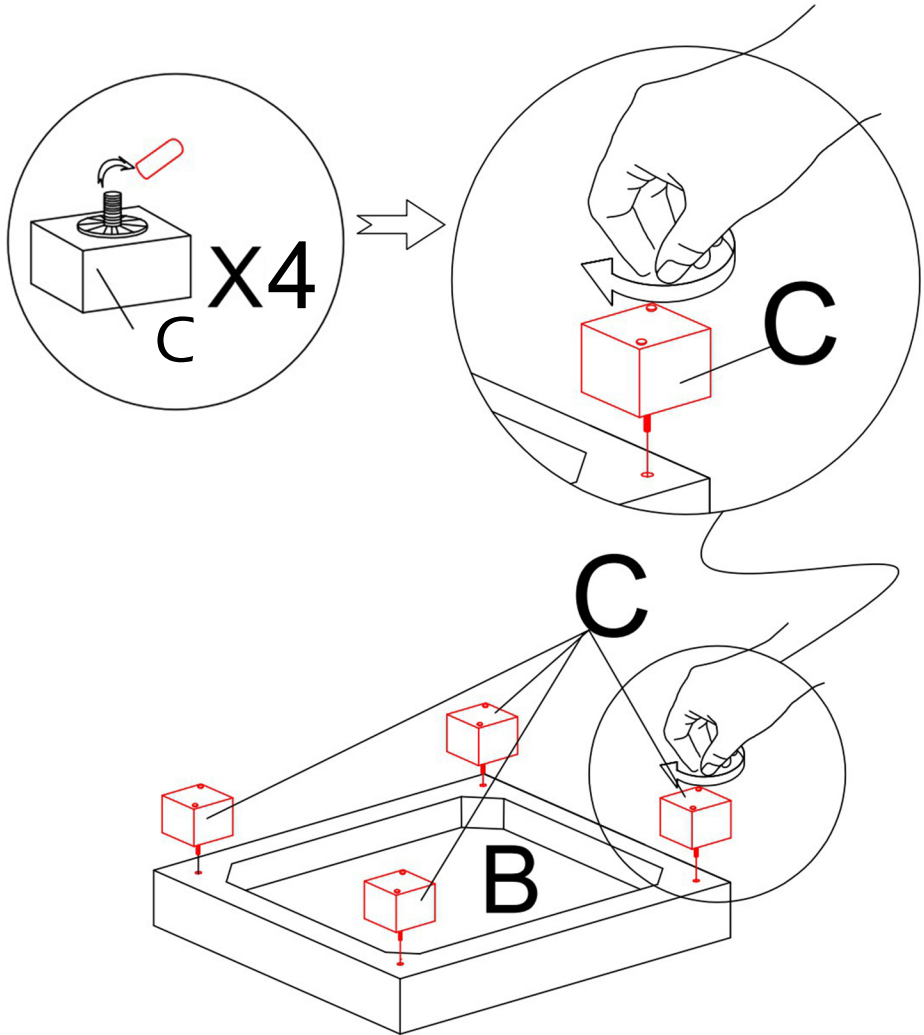

step 3

Place the seat cushion (A) onto the ottoman frame (B).

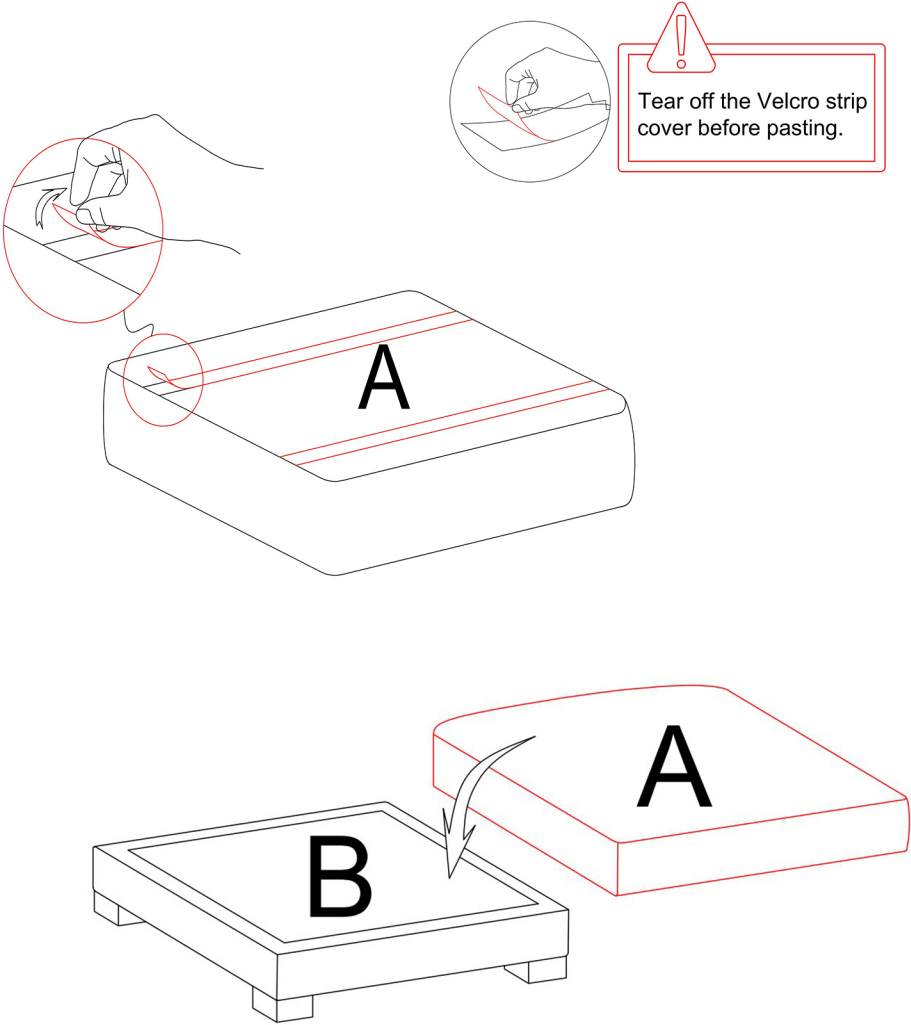

step 4

There is a metal buckle inside the carton as a free part.
If you only purchased single part of the sofa, this buckle will not be useful.

If you want to be combined with other sofa components (ottoman, chair ,chaise etc), this buckle can be used.

Just use this buckle to fix two parts together from the bottom to prevent displacement while using the products.

Congrats! You have finished assembly!

