

WARRANTY INFORMATION

- Do not expose the surfaces to direct sunlight or to extreme environmental conditions.
- Clean the surfaces preferable with a clean damp cloth, then dry with a clean towel.
- Do not use solvents or abrasive materials to clean the unit. If you decide to use a cleaning agent, test first on an area hidden from view.
- Replacement parts might be available to you at no charge, with an original proof of purchase and where a defect has arisen, wholly or substantially, as a result of faulty manufacturing, parts or workmanship during the Warranty Period.
- The warranty does not extend to regular wear and tear, nor the manufacturer assumes liability for damages or consequences due to accidents, incorrect assembly, negligence, improper use, modifications, or not heeding the above warnings.

Thank you so much for your support! We hope you enjoy your purchase. If there is any damage or missing accessories, please feel free to contact us for free replacement or refund.

Thank you !

TABLE OF CONTENTS

01 Warranty Information

02 Important Safety Instructions

02 Tools Needed

03 Parts List

04 Assembly

IMPORTANT SAFETY INSTRUCTIONS

- Check if all the parts are complete before installation.
- Read through the instructions before installing the cabinet.
- Keep the small parts away from children to avoid the risk of swallowing.
- Screw the cabinet to the wall to avoid the risk of falling down.

TOOLS NEEDED

Screws Driver -1PC





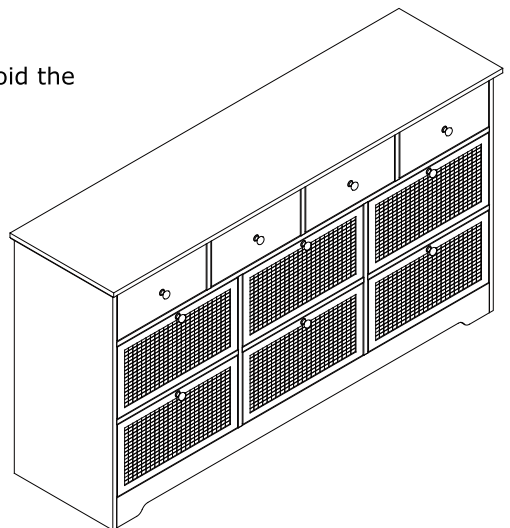

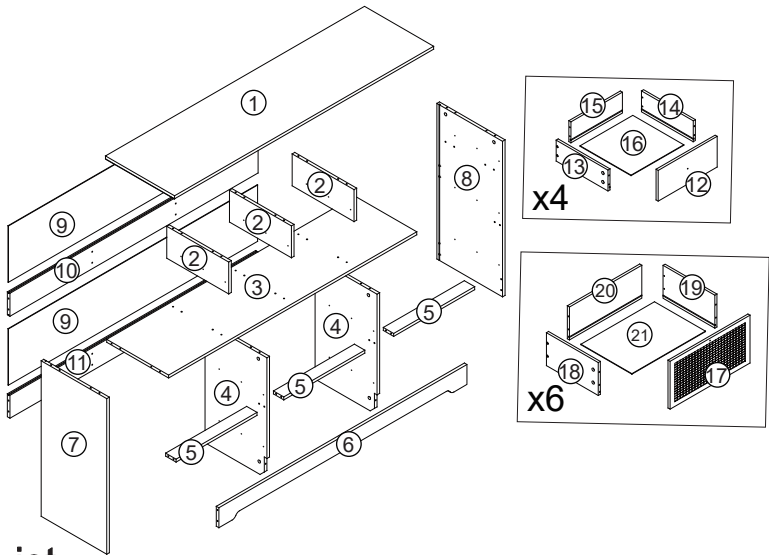



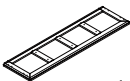

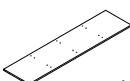
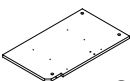
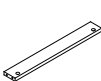

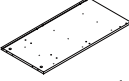
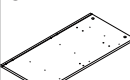





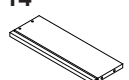

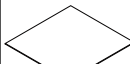
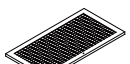
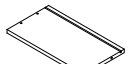
(Not included)

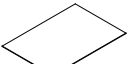













Packing List

1  x1	2  x3	3  x1	4  x2	5  x3	6  x1	7  x1
8  x1	9  x2	10  x1	11  x1	12  x4	13  x4	14  x4
15  x4	16  x4	17  x6	18  x6	19  x6	20  x6	21  x6

A  x78	B  x78	C M6x30  x26	D M4x40  x56	E M3.5x12  x100	F M4x18  x10
-------------------------------------------------------------------------------------------------------	--------------------------------------------------------------------------------------------------------	--------------------------------------------------------------------------------------------------------------	--------------------------------------------------------------------------------------------------------------	-----------------------------------------------------------------------------------------------------------------	--------------------------------------------------------------------------------------------------------------







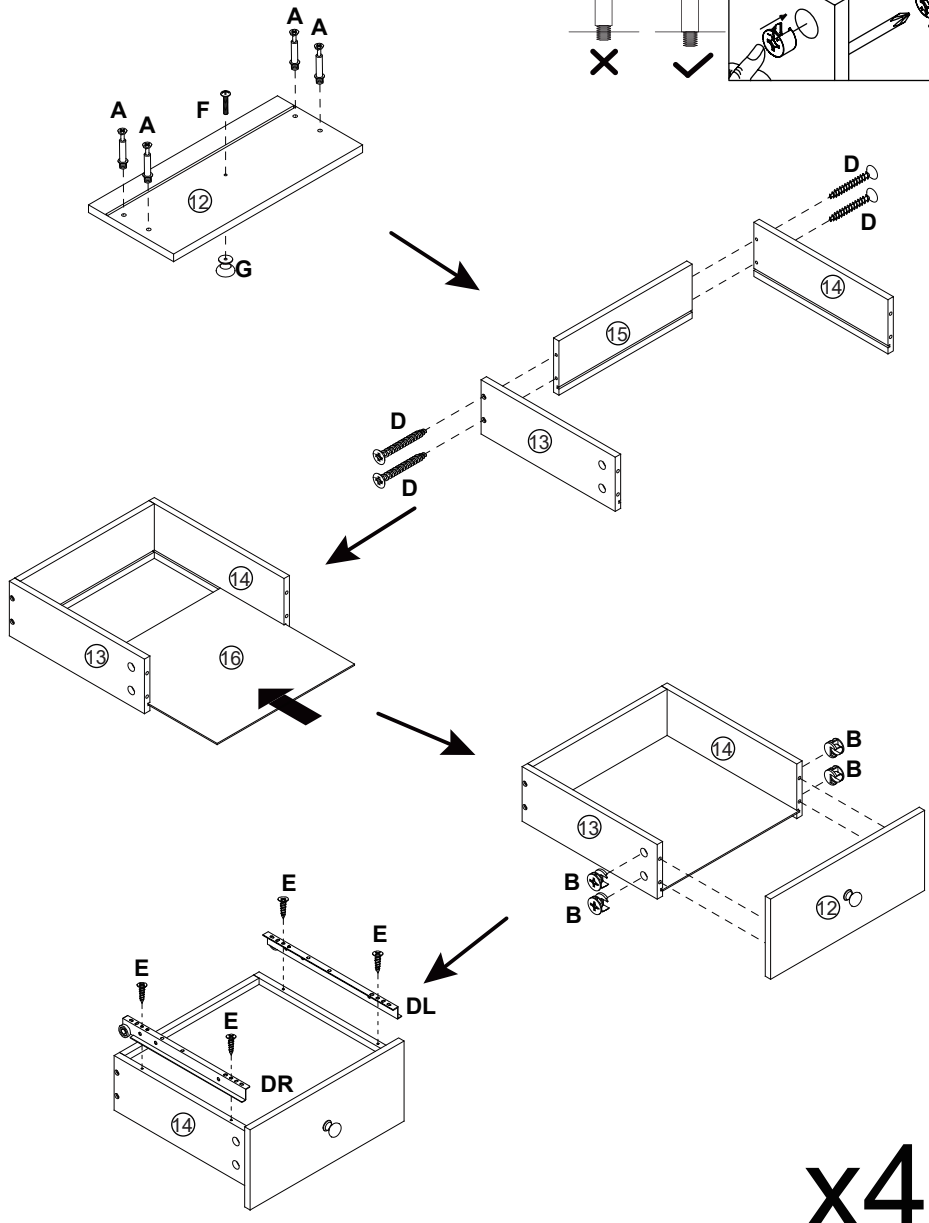
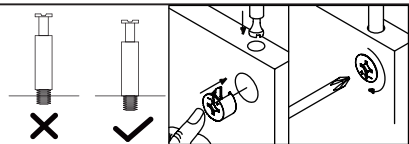

G  x10	H  x12	I M3x16  x12	J  x2	K M4x12  x2	L  x2	M M6x50  x2
--------------------------------------------------------------------------------------------------------	--------------------------------------------------------------------------------------------------------	--------------------------------------------------------------------------------------------------------------	-------------------------------------------------------------------------------------------------------	-------------------------------------------------------------------------------------------------------------	-------------------------------------------------------------------------------------------------------	--------------------------------------------------------------------------------------------------------------

CL  x10	CR  x10	DL  x10	DR  x10
--------------------------------------------------------------------------------------------------------	---------------------------------------------------------------------------------------------------------	---------------------------------------------------------------------------------------------------------	---------------------------------------------------------------------------------------------------------

Step 1









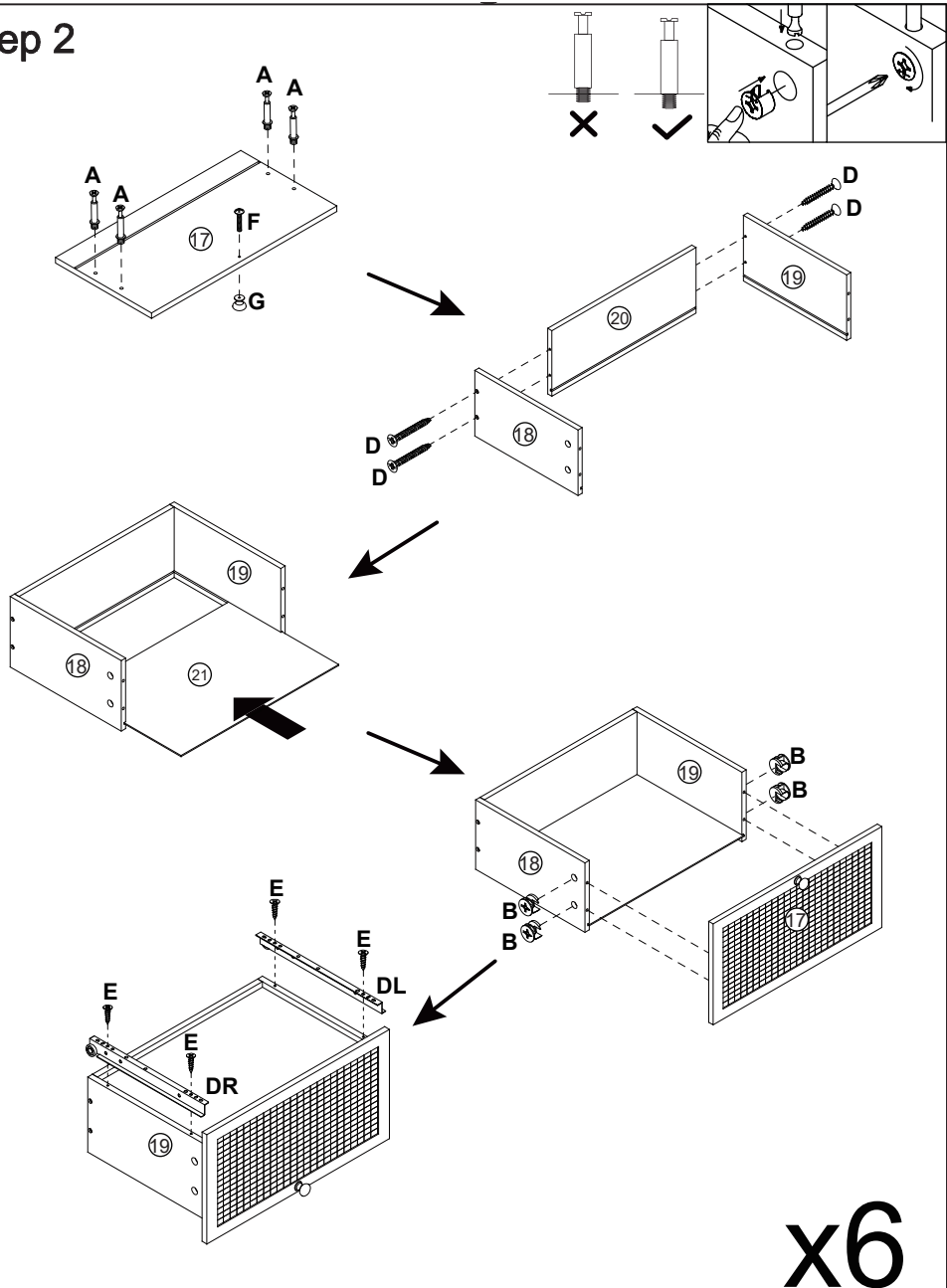

x4

<p>A</p>  <p>x16</p>	<p>B</p>  <p>x16</p>	<p>D</p>  <p>x16</p>	<p>E</p>  <p>x16</p>	<p>F</p>  <p>x4</p>	<p>G</p>  <p>x4</p>	<p>DL</p>  <p>x4</p>	<p>DR</p>  <p>x4</p>
---------------------------------------------------------------------------------------------------------------	----------------------------------------------------------------------------------------------------------------	----------------------------------------------------------------------------------------------------------------	----------------------------------------------------------------------------------------------------------------	---------------------------------------------------------------------------------------------------------------	---------------------------------------------------------------------------------------------------------------	----------------------------------------------------------------------------------------------------------------	-----------------------------------------------------------------------------------------------------------------

Step 2





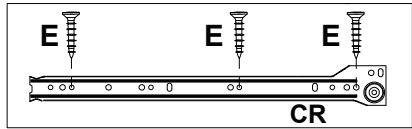
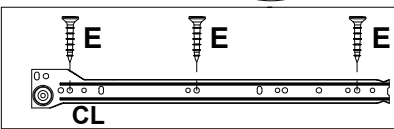
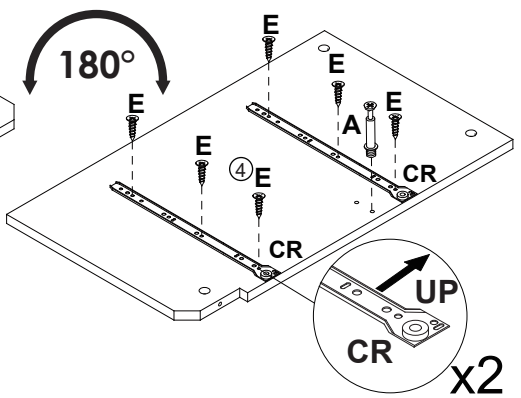
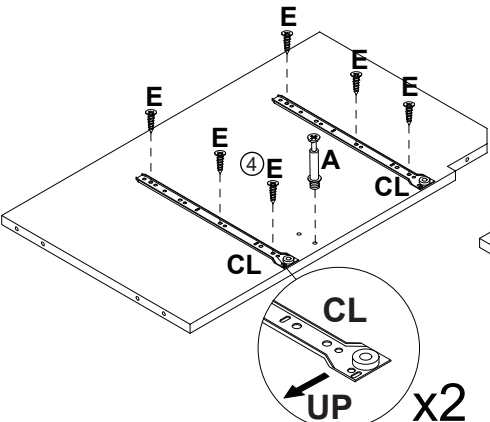
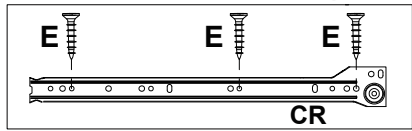
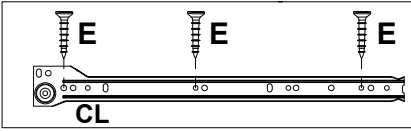
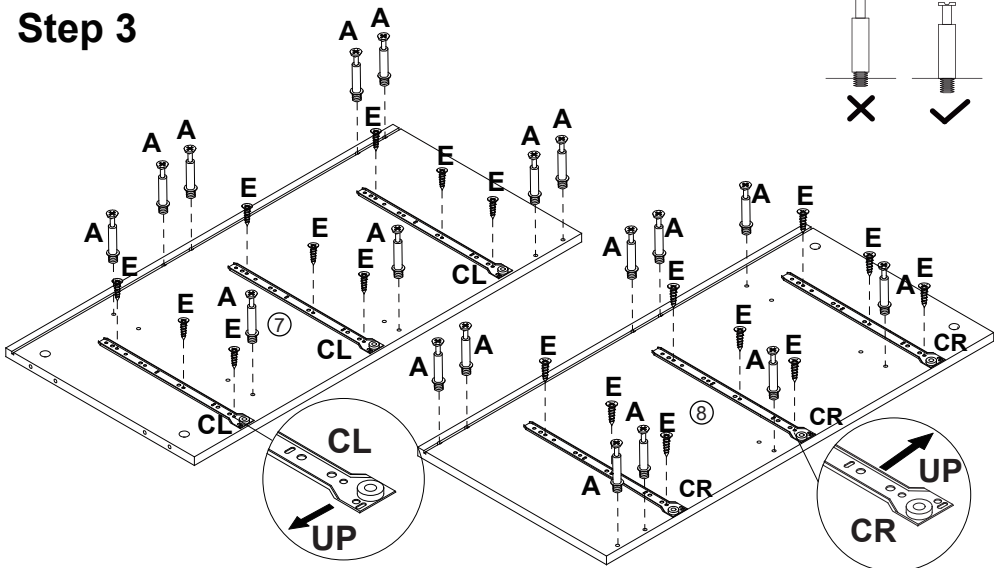
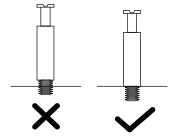

x6

<p>A</p>  <p>x24</p>	<p>B</p>  <p>x24</p>	<p>D</p>  <p>x24</p>	<p>E</p>  <p>x24</p>	<p>F</p>  <p>x6</p>	<p>G</p>  <p>x6</p>	<p>DL</p>  <p>x6</p>	<p>DR</p>  <p>x6</p>
---------------------------------------------------------------------------------------------------------------	----------------------------------------------------------------------------------------------------------------	----------------------------------------------------------------------------------------------------------------	----------------------------------------------------------------------------------------------------------------	---------------------------------------------------------------------------------------------------------------	---------------------------------------------------------------------------------------------------------------	----------------------------------------------------------------------------------------------------------------	-----------------------------------------------------------------------------------------------------------------

Step 3



<p>A</p>  <p>x22</p>	<p>E</p>  <p>x42</p>	<p>CL</p>  <p>x7</p>	<p>CR</p>  <p>x7</p>
----------------------------------------------------------------------------------------------------------------	----------------------------------------------------------------------------------------------------------------	----------------------------------------------------------------------------------------------------------------	-----------------------------------------------------------------------------------------------------------------

Step 4

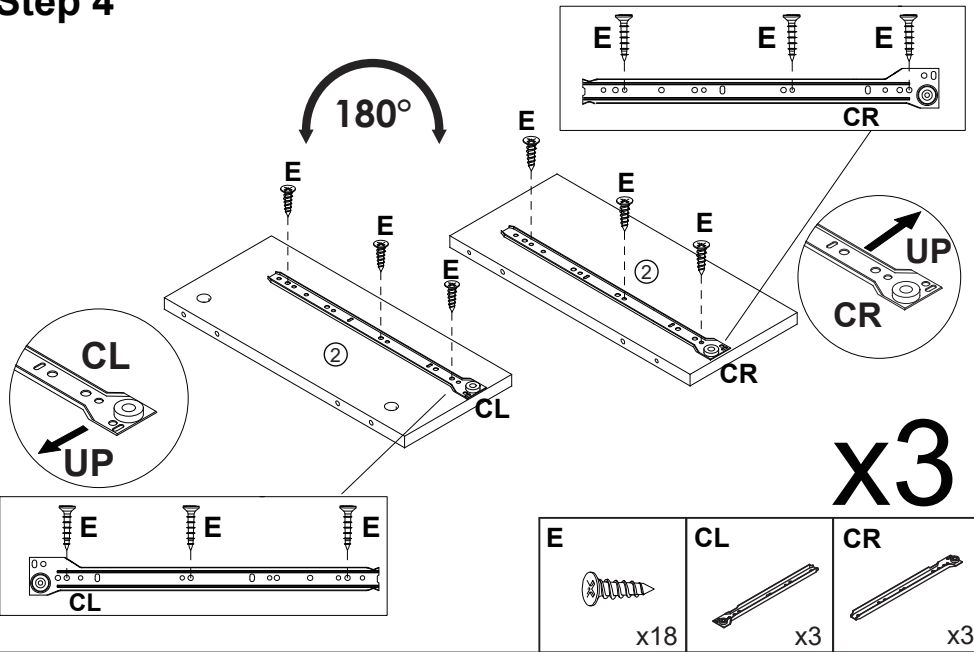

Step 5

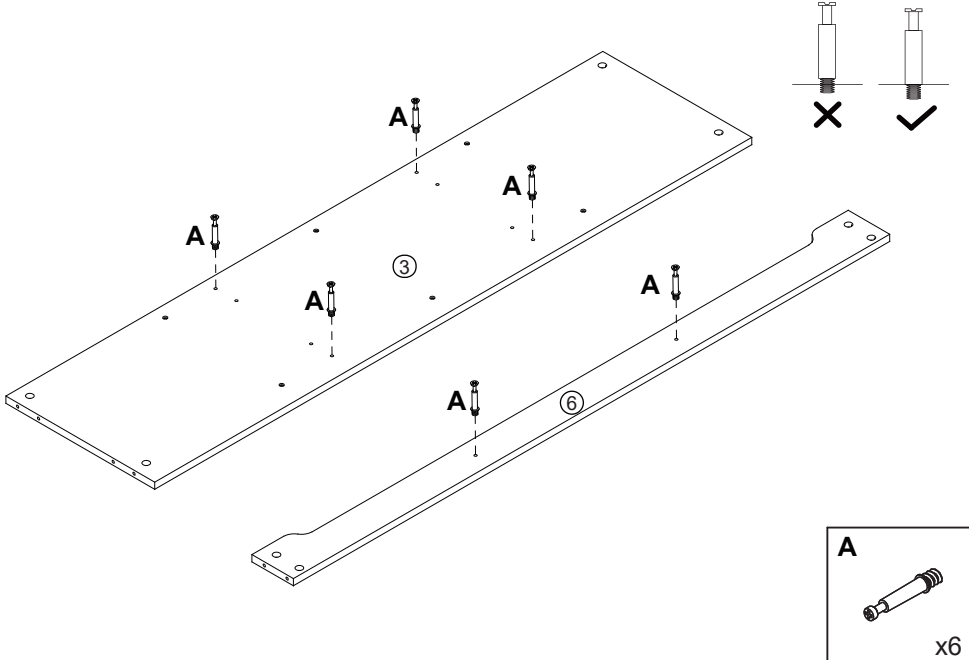

Step 6

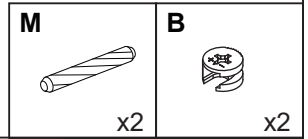
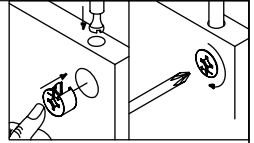
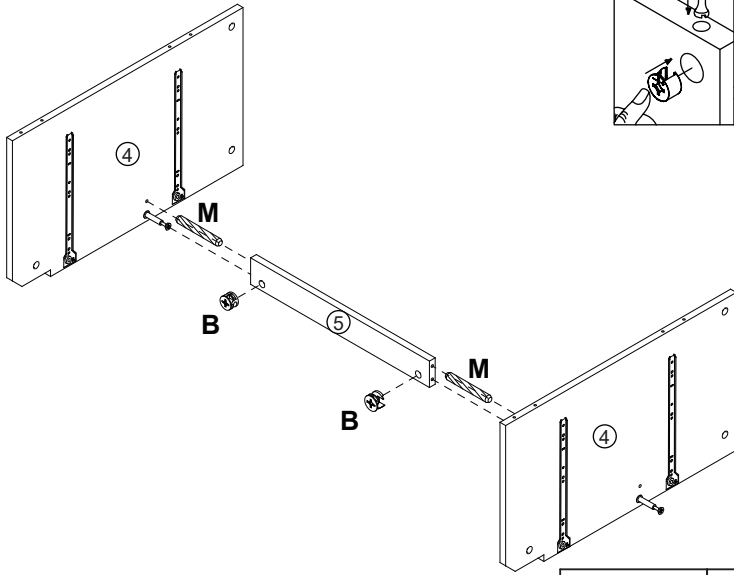

Step 7

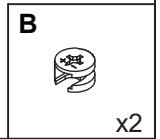
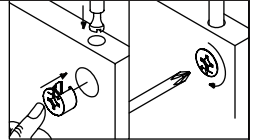
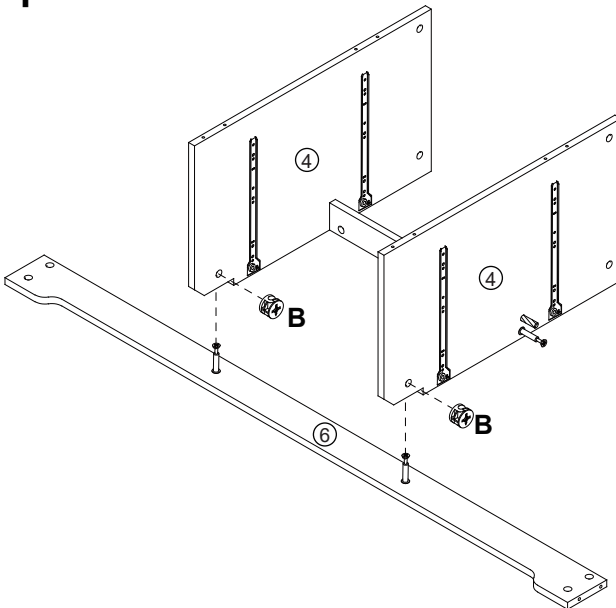

Step 8

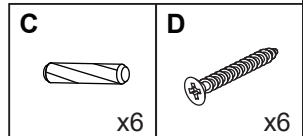
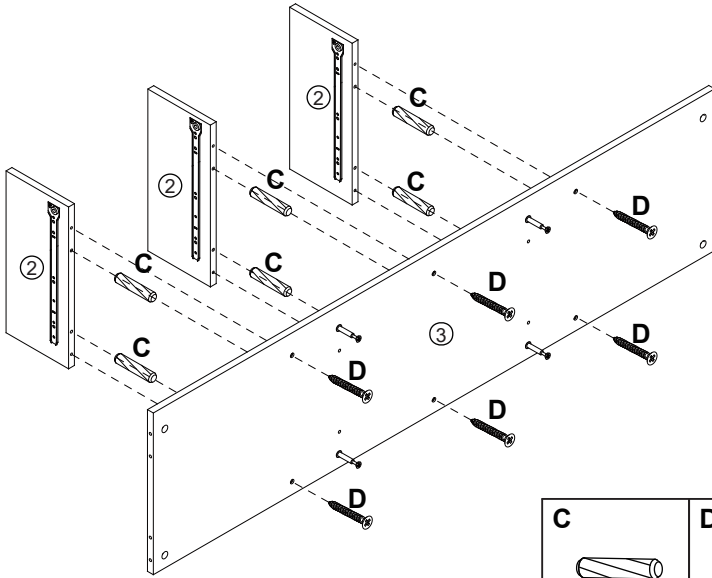

Step 9

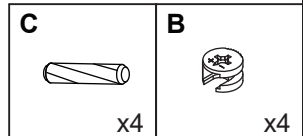
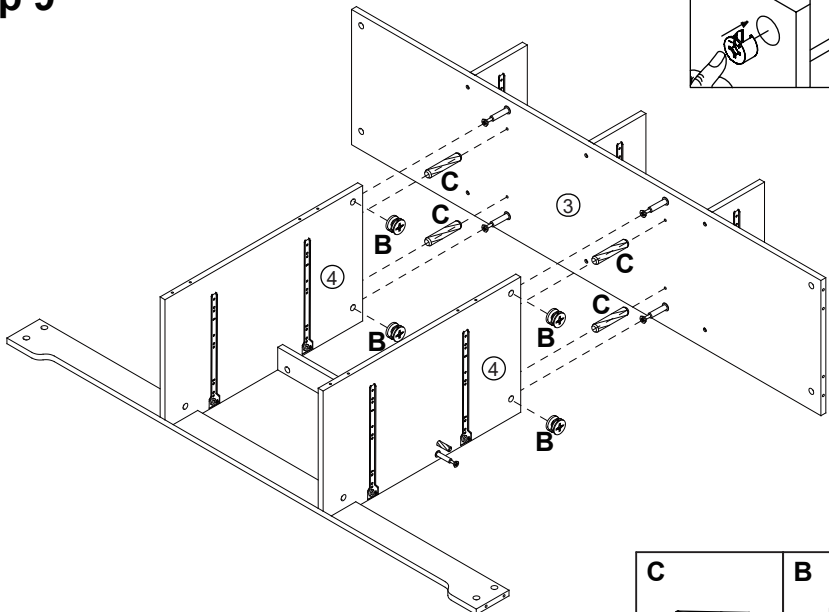

Step 10

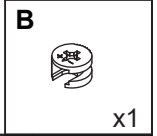
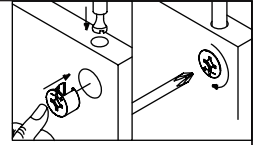
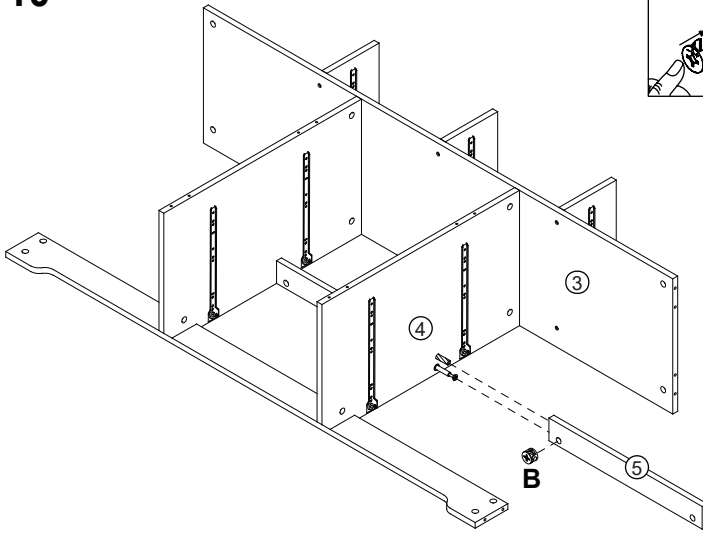

Step 11

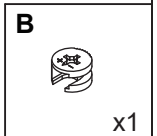
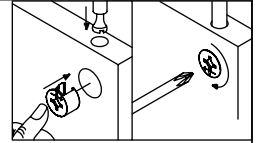
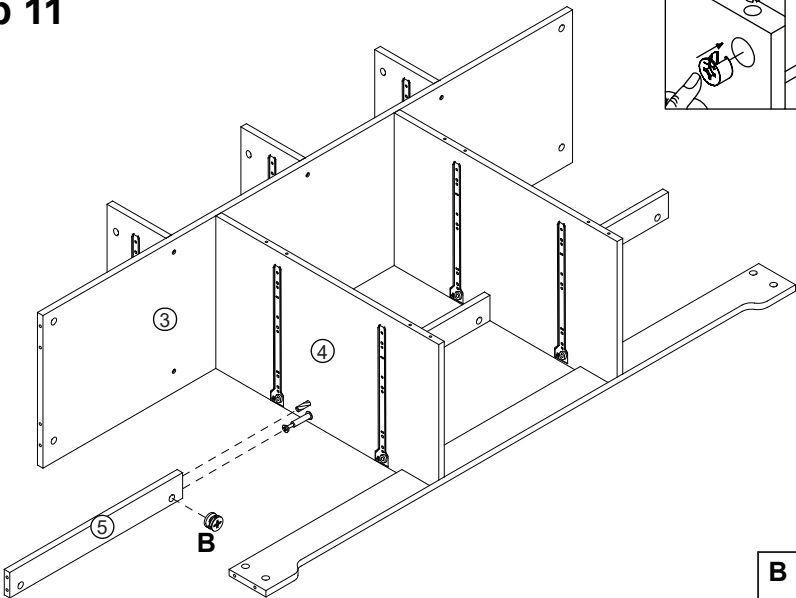

Step 12

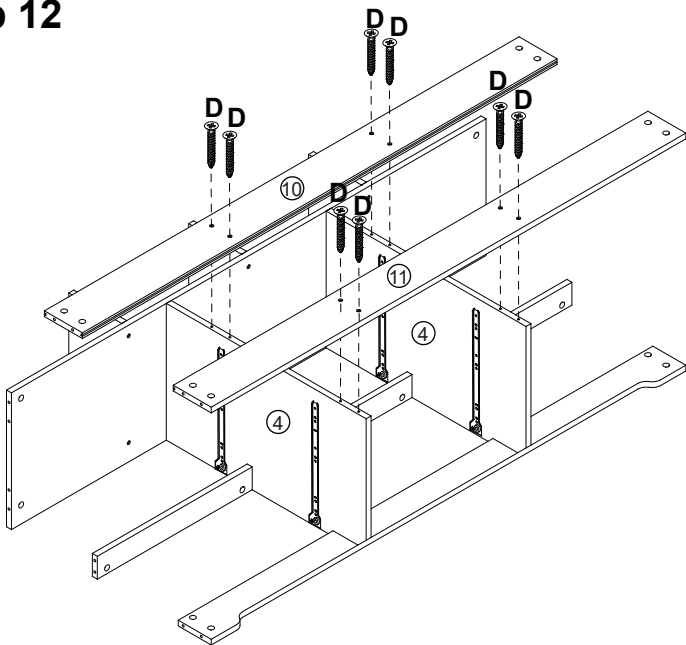

D



x8

Step 13

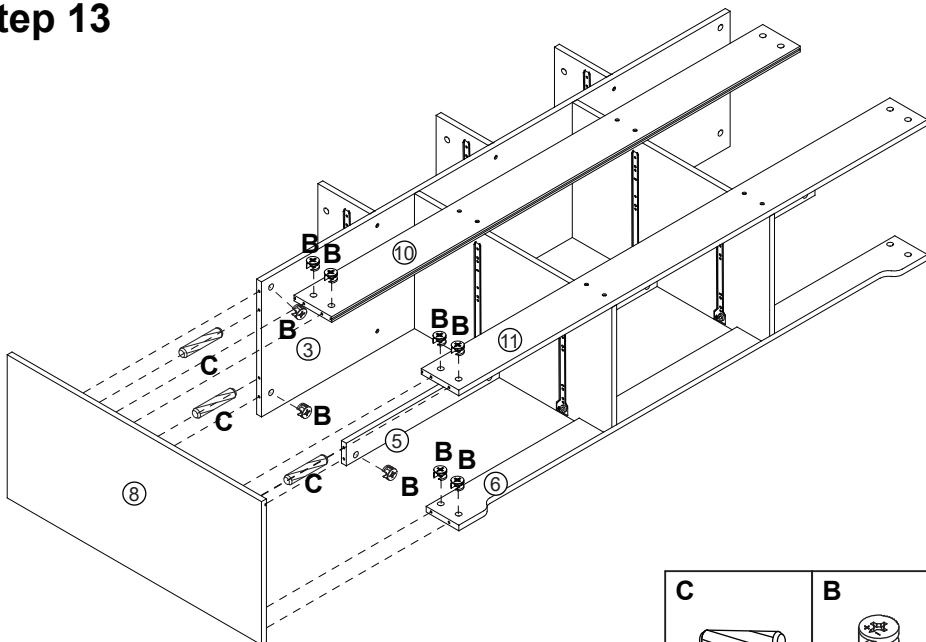

C



x3

B



x9

Step 14

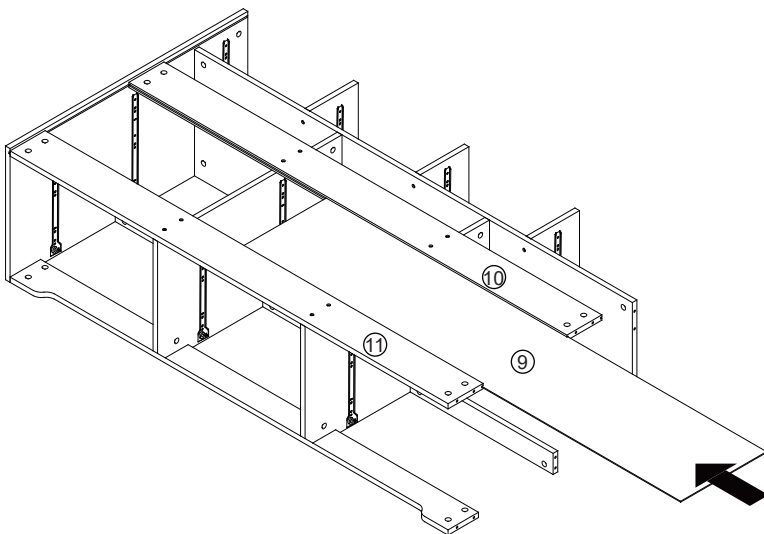

Step 15

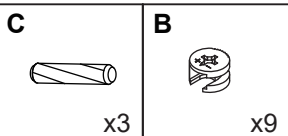
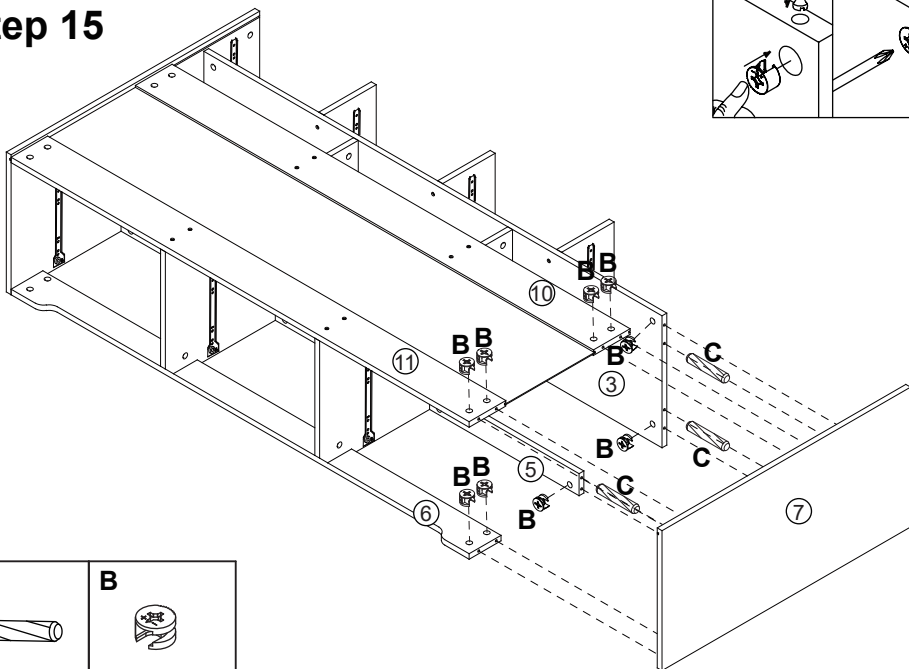

Step 16

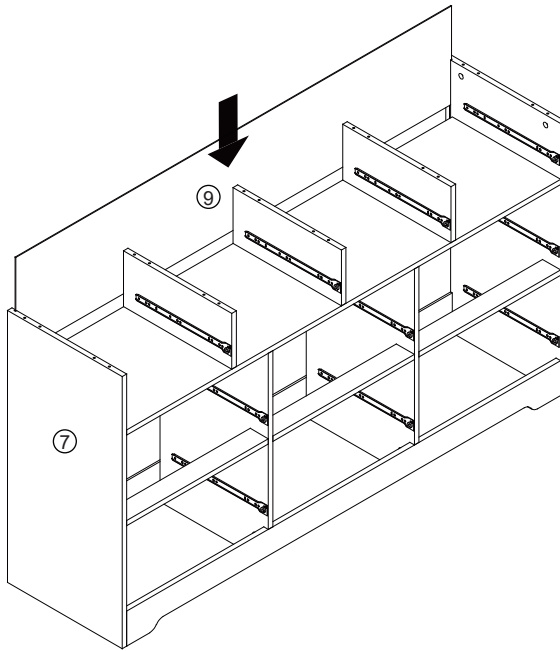

Step 17

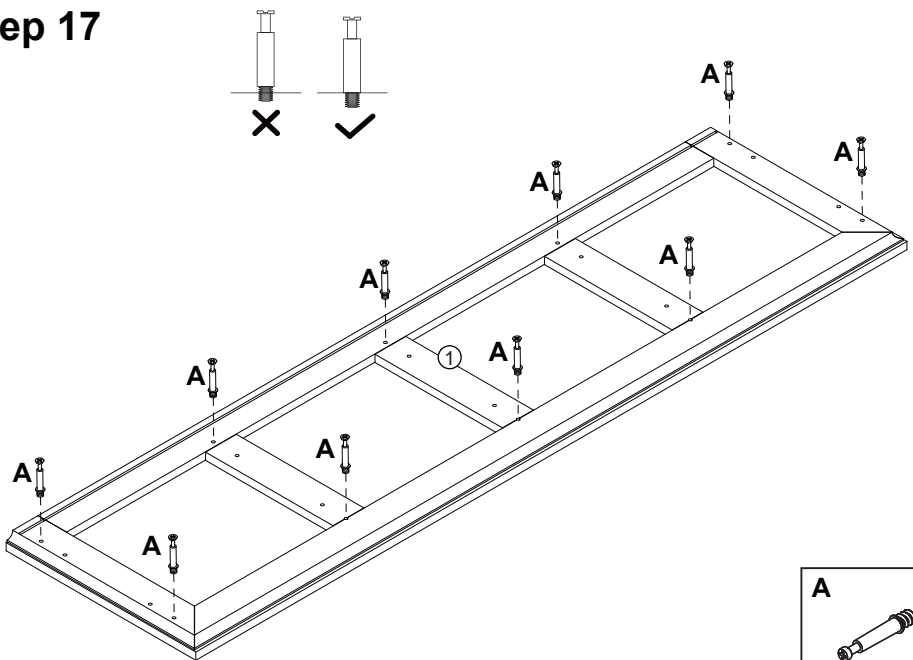

Step 18

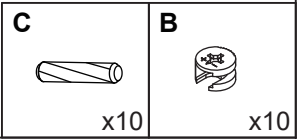
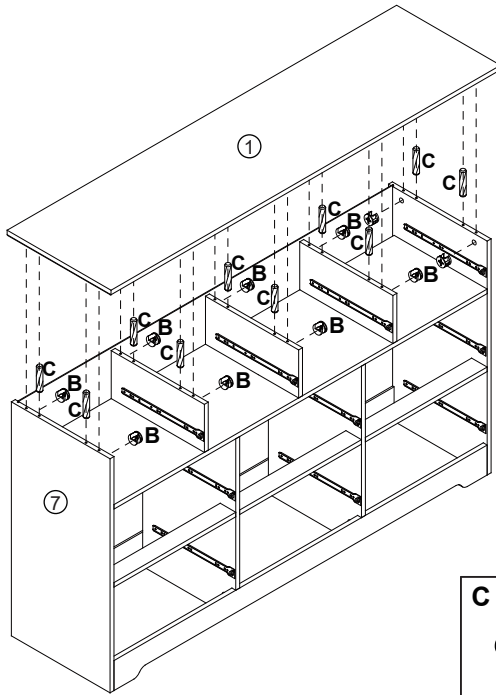

Step 19

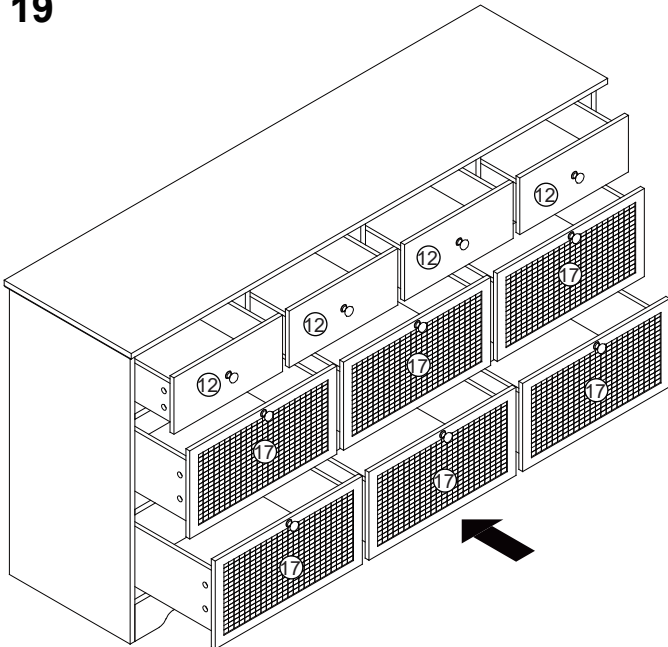

Step 20

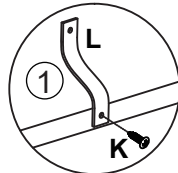
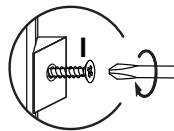
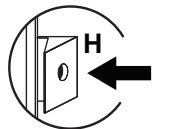
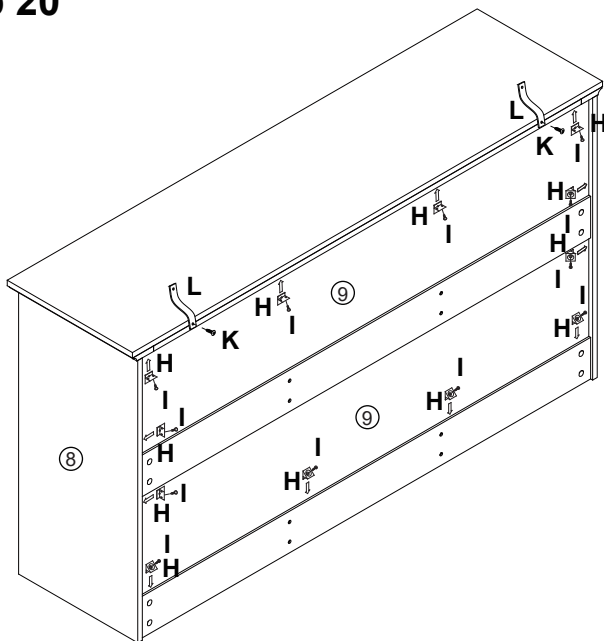

<p>H</p> <p>x12</p>	<p>I</p> <p>x12</p>
<p>L</p> <p>x2</p>	<p>K</p> <p>x2</p>

Step 21

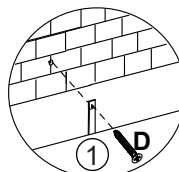
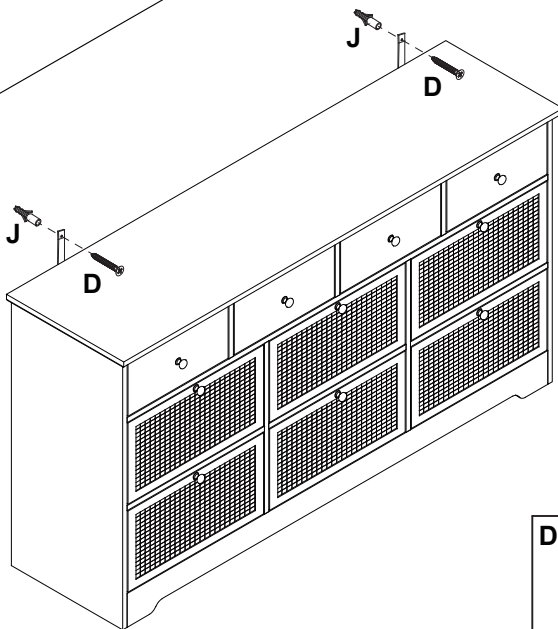

<p>D</p> <p>x2</p>	<p>J</p> <p>x2</p>
--------------------	--------------------