

ASSEMBLY INSTRUCTIONS

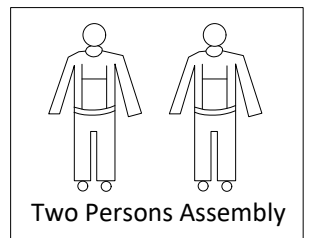

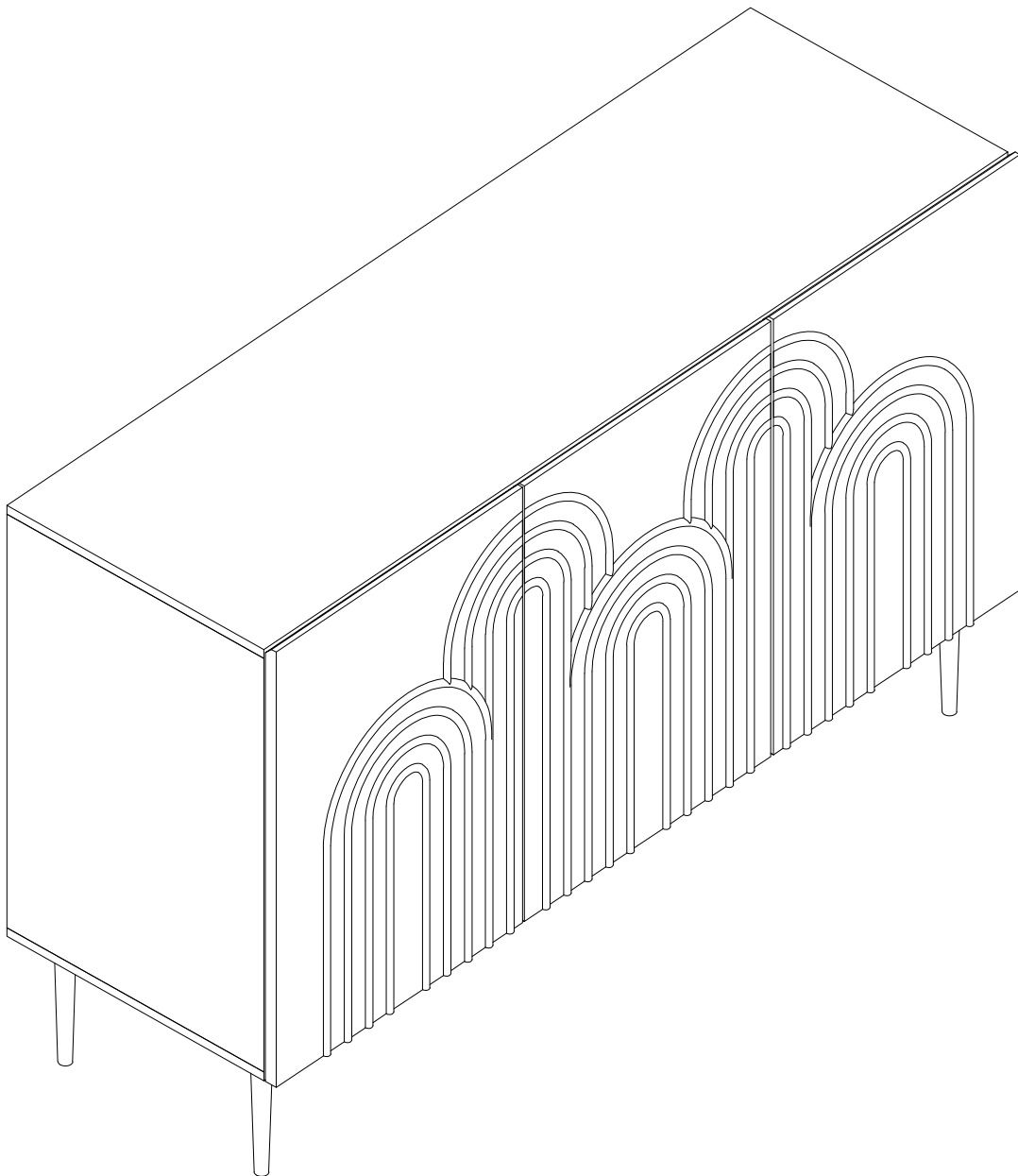

ASSEMBLY TOOLS REQUIRED (NOT INCLUDED)

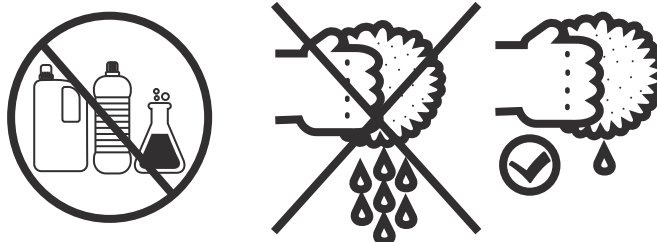
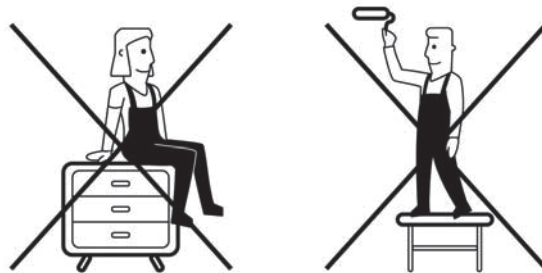
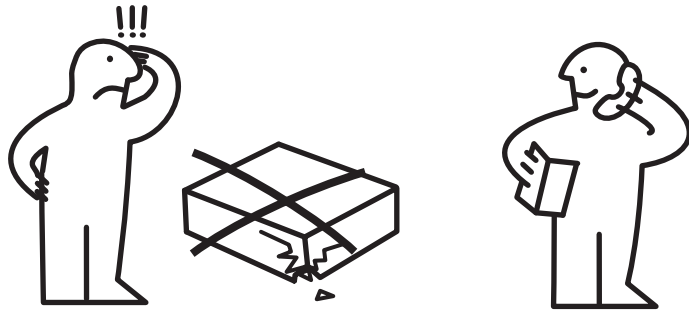
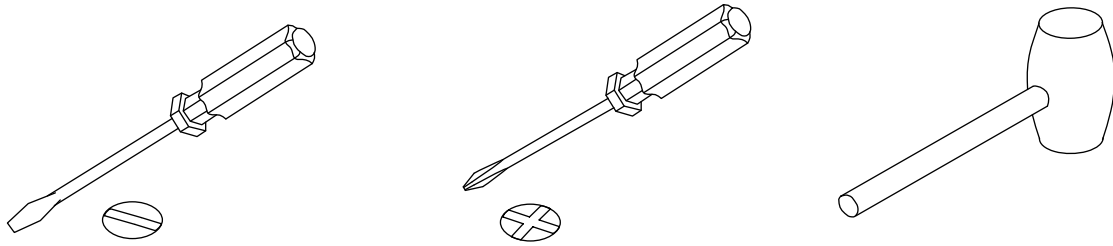

- * Before discarding packing materials, please check all parts and hardware are presented.
- * Please follow the instructions closely.
- * After few days of initial assembly, the product may have acclimated to new environment, please tighten all hardware again.

Dowel Installation

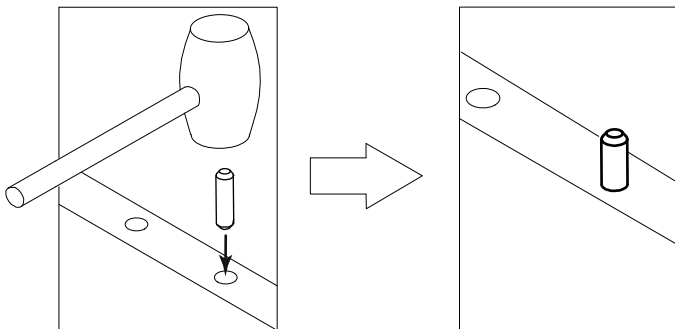

Gently tap dowel into hole with rubber mallet.

CAM-LOCK

Tighten until shoulder is flush with panel. Do not overtighten or undertighten

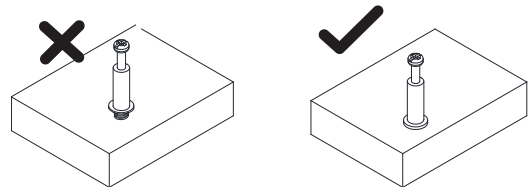
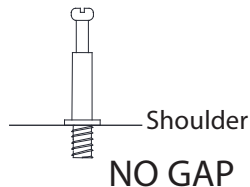

WHEN FITTING CAMS

ENSURE STARTING POSITION IS CORRECT
BEFORE YOU INSERT CONNECTING CAM-PILLAR
TURN CLOCKWISE UNTIL SECURE

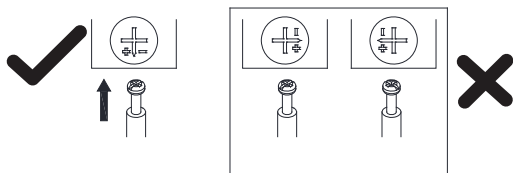

Laying out all the parts and hardware and identifying each part as shown below. It may help you when you assemble the item.

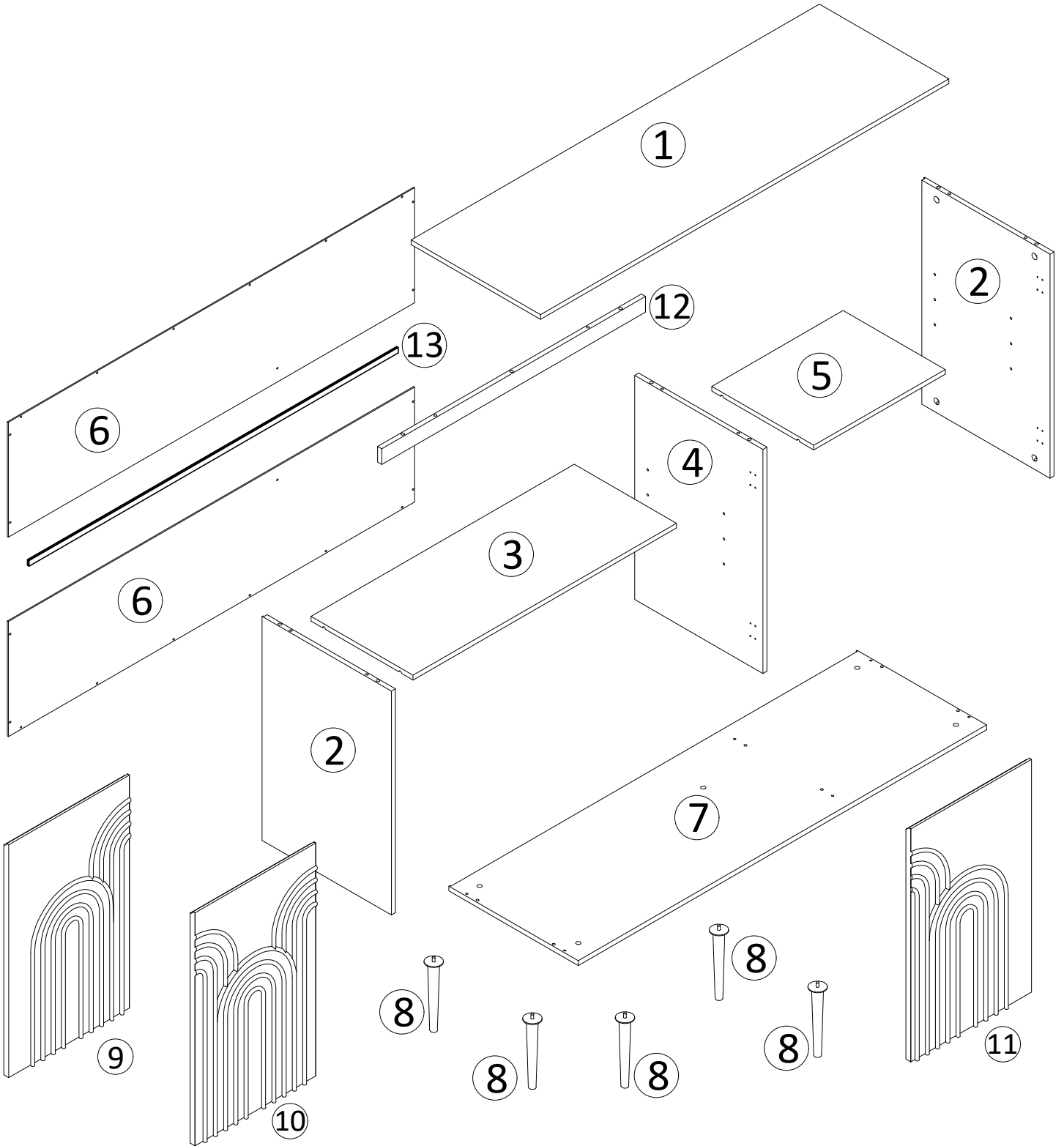

① × 1

② × 2

③ × 1

④ × 1

⑤ × 1

⑥ × 2

⑦ × 1

⑧ × 5

⑨ × 1

⑩ × 1

⑪ × 1

⑫ × 1

⑬ × 1

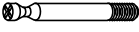
A	×15+1(Spare)
	
φ6×27mm	

B	×15+2(Spare)
	
φ15×10mm	

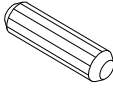
C	×14+1(Spare)
	
φ6×30mm	

D	×5
	
M6×15L-φ16×7T	

E	×8+1(Spare)
	
5×8/5×8mm	

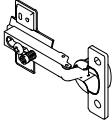
F	×6
	
Ø35mm	

G	×36+2(Spare)
	
FA3.5×14mm	

H	×20+2(Spare)
	
FA3×10mm	

I	×5
	
φ21	

J	×2
	
FA4×40mm/FA4×12mm	

K	×6
	
φ8×2mm	

1

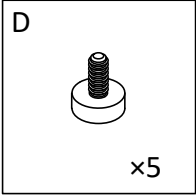
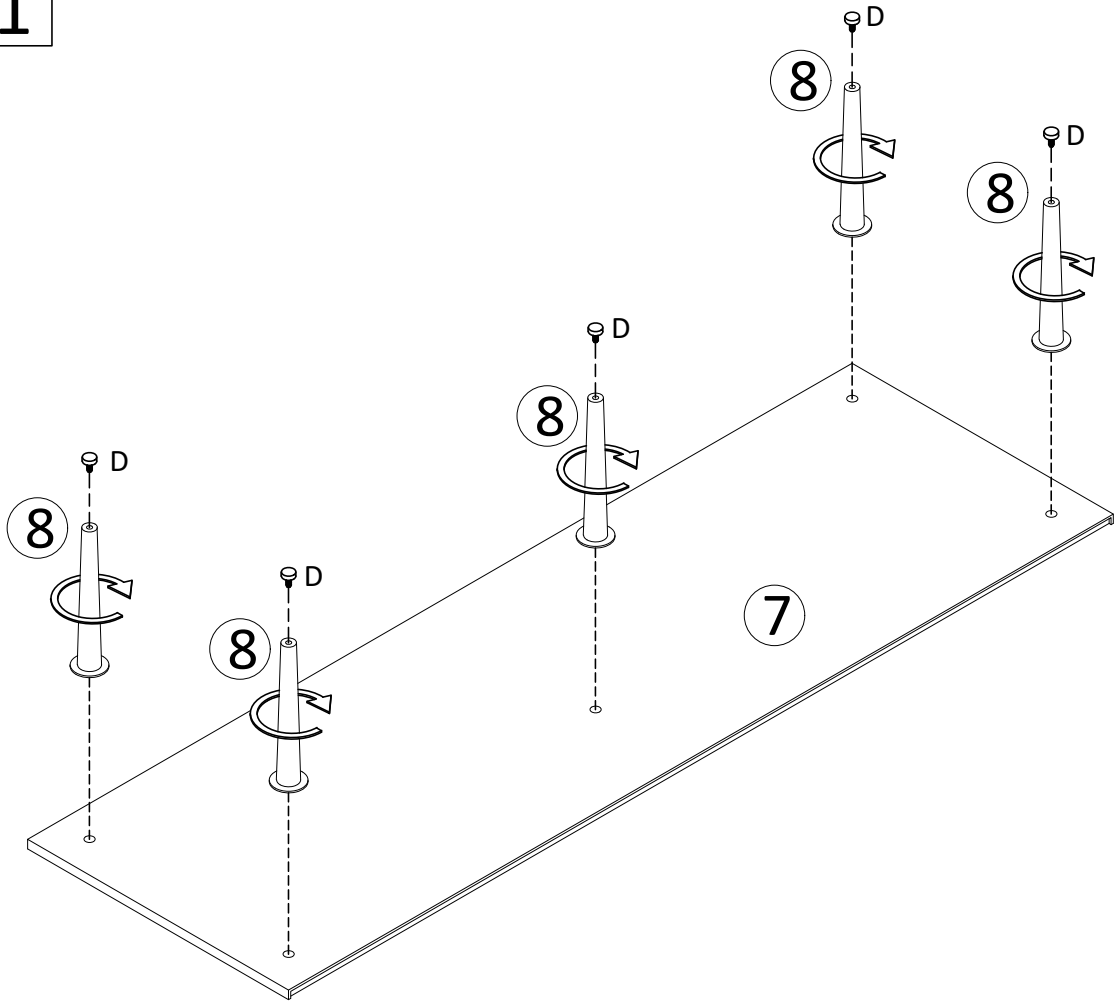

2

Turn the screws vertically from slow to fast.

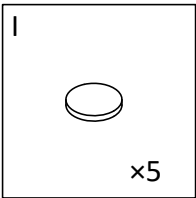
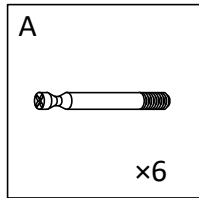
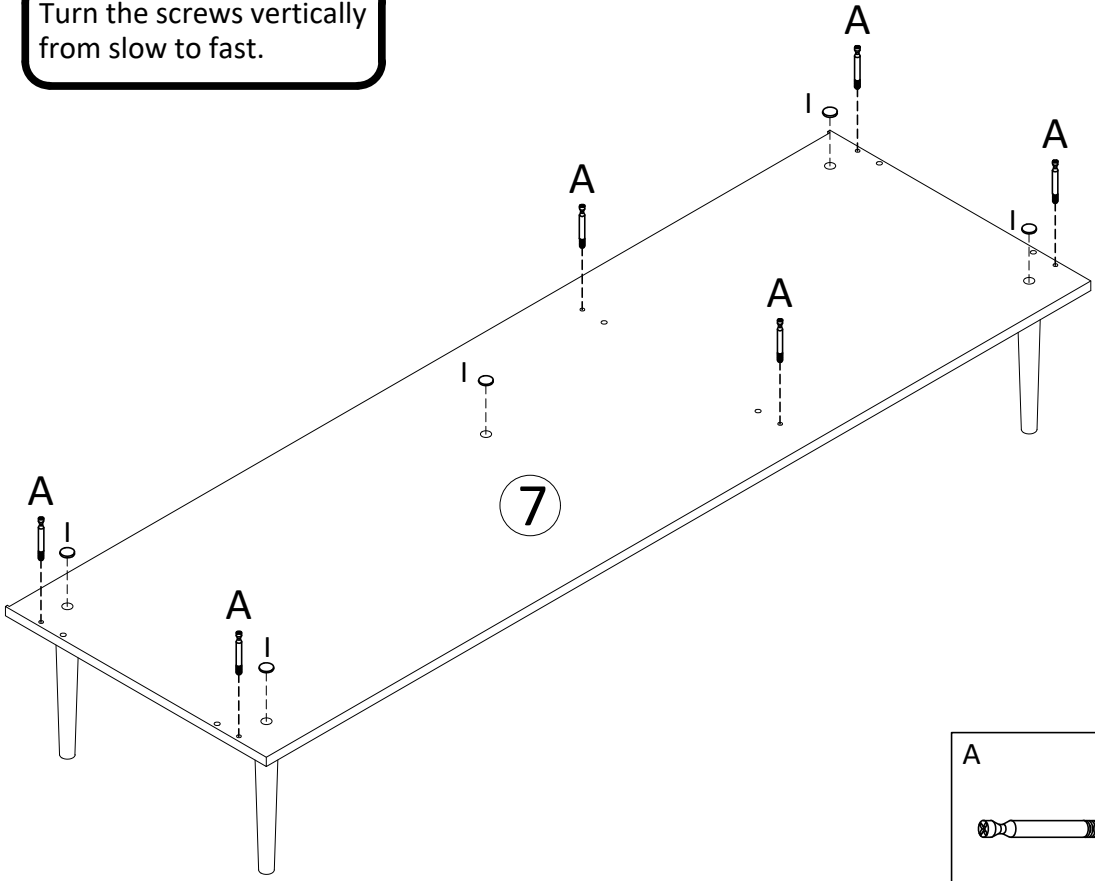

3

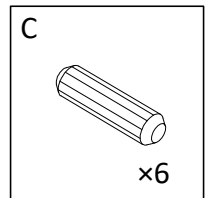
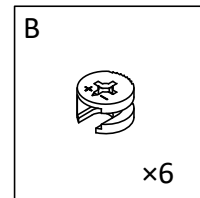
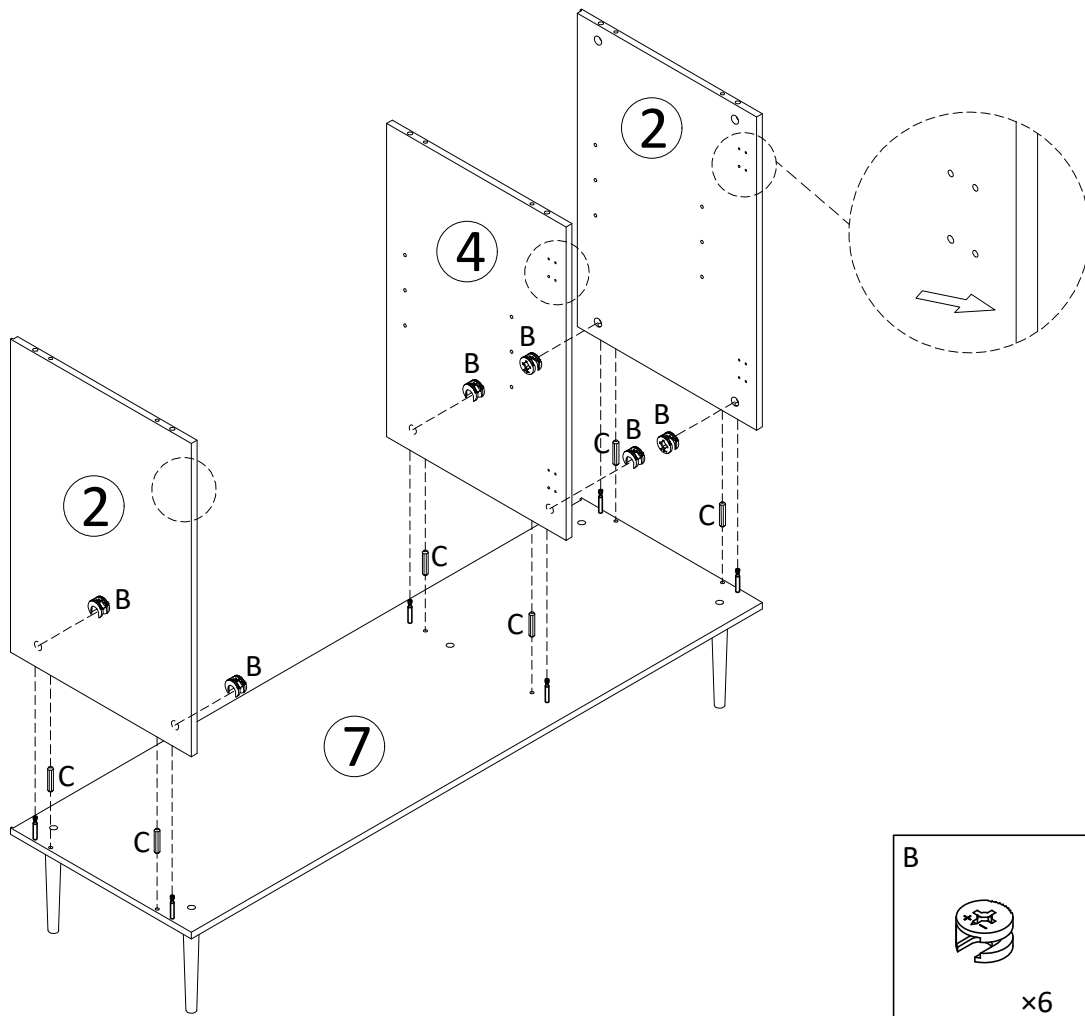

4

Turn the screws vertically from slow to fast.

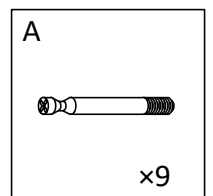
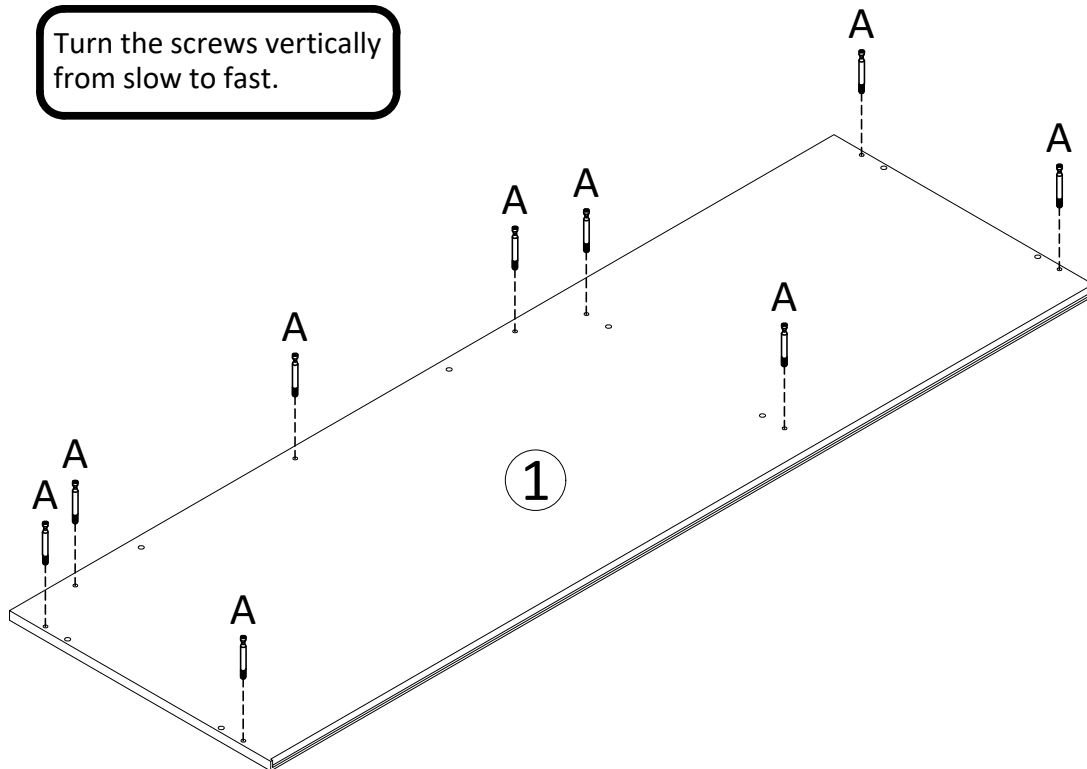

5

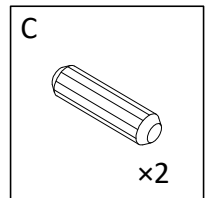
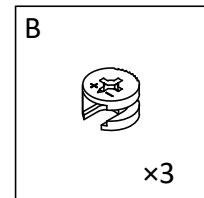
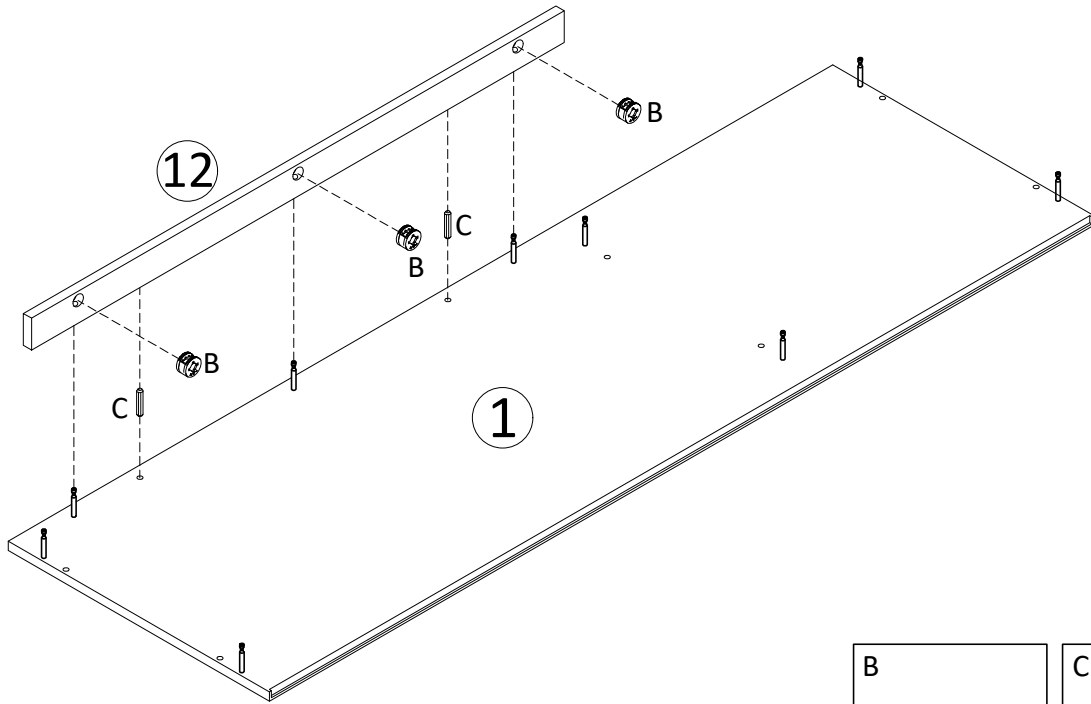

6

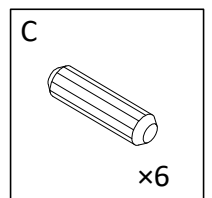
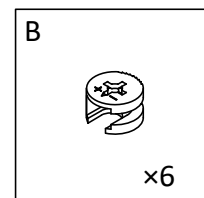
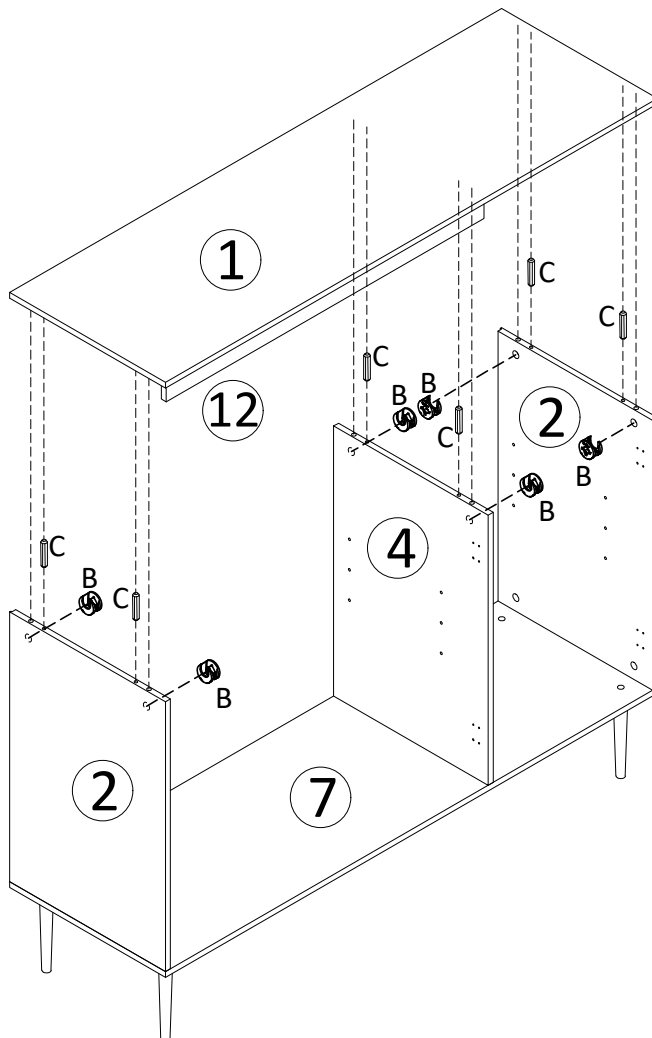

7

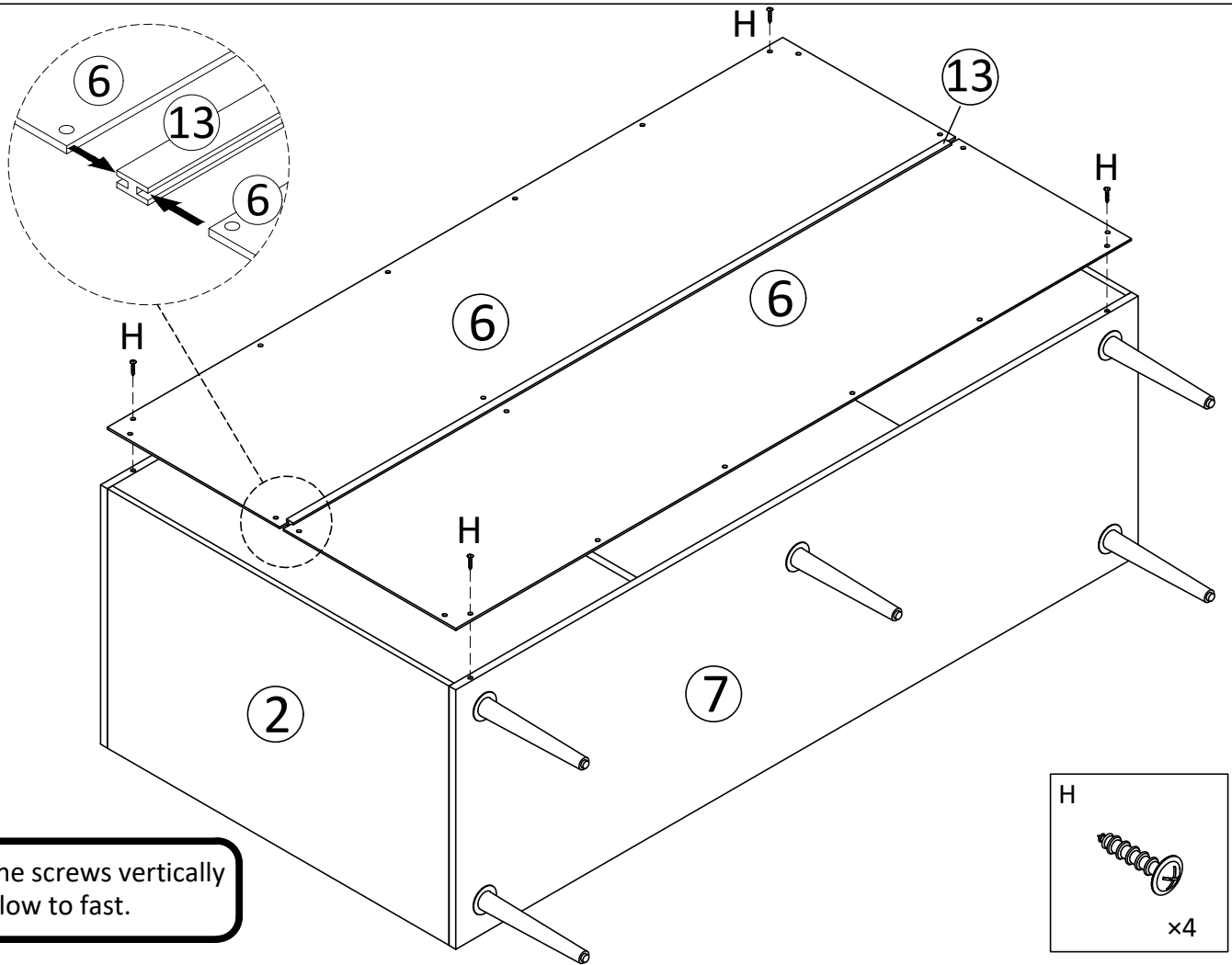

Turn the screws vertically from slow to fast.

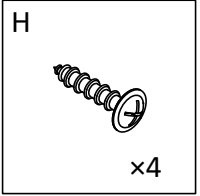

8

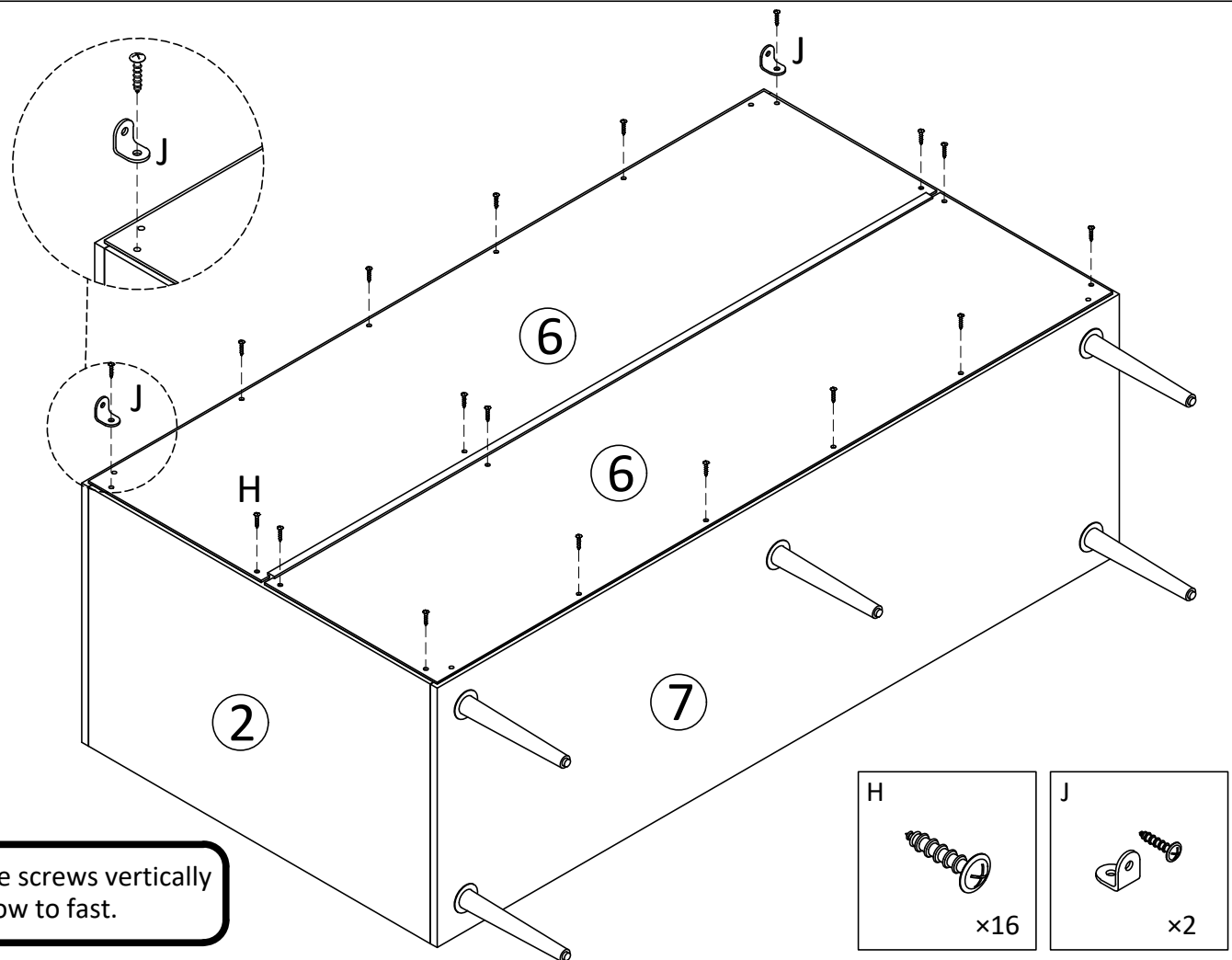

Turn the screws vertically from slow to fast.

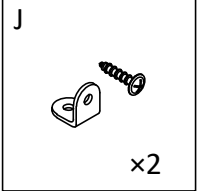
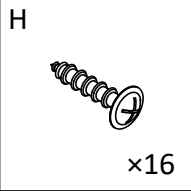

9

Turn the screws vertically
from slow to fast.

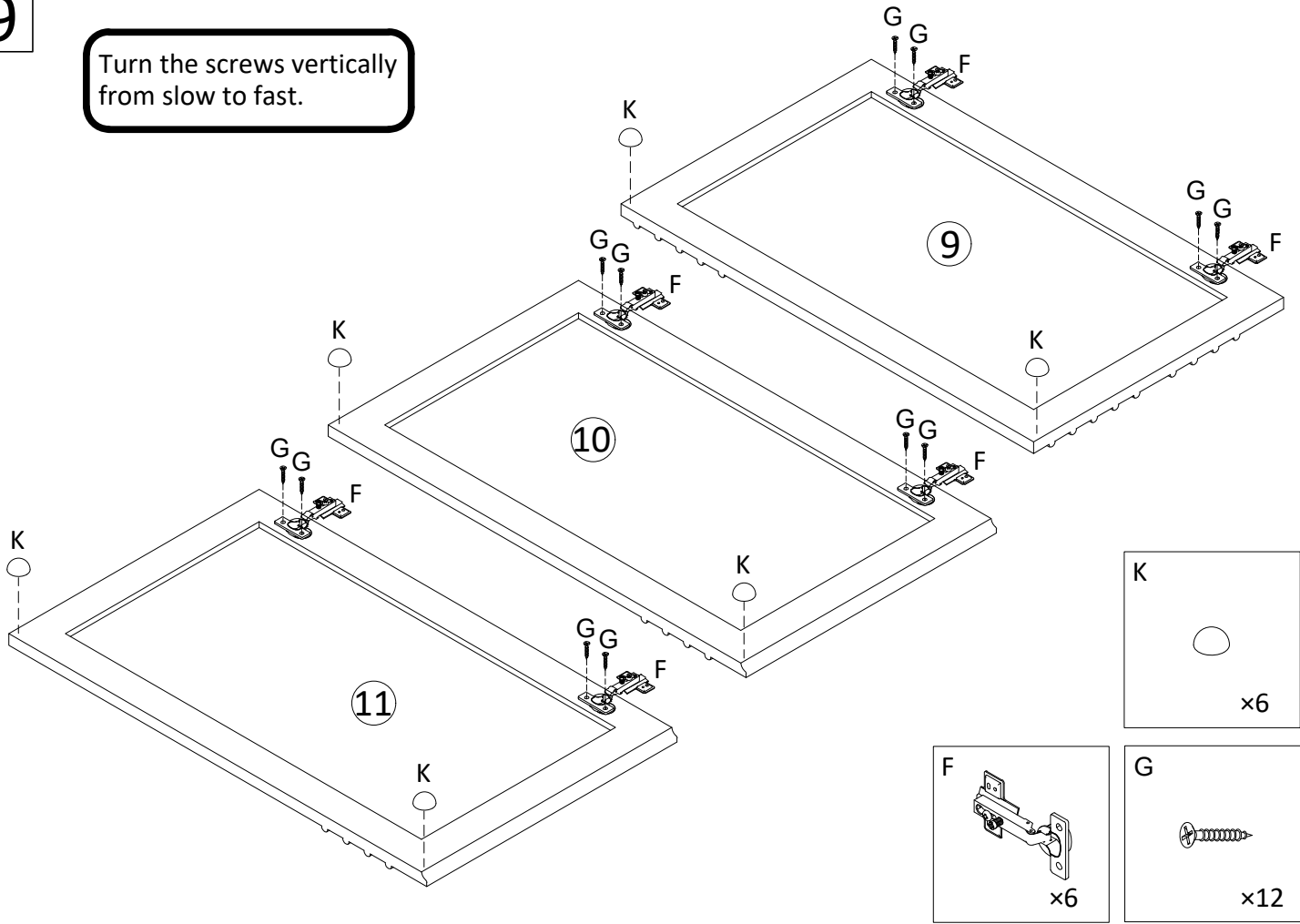

10

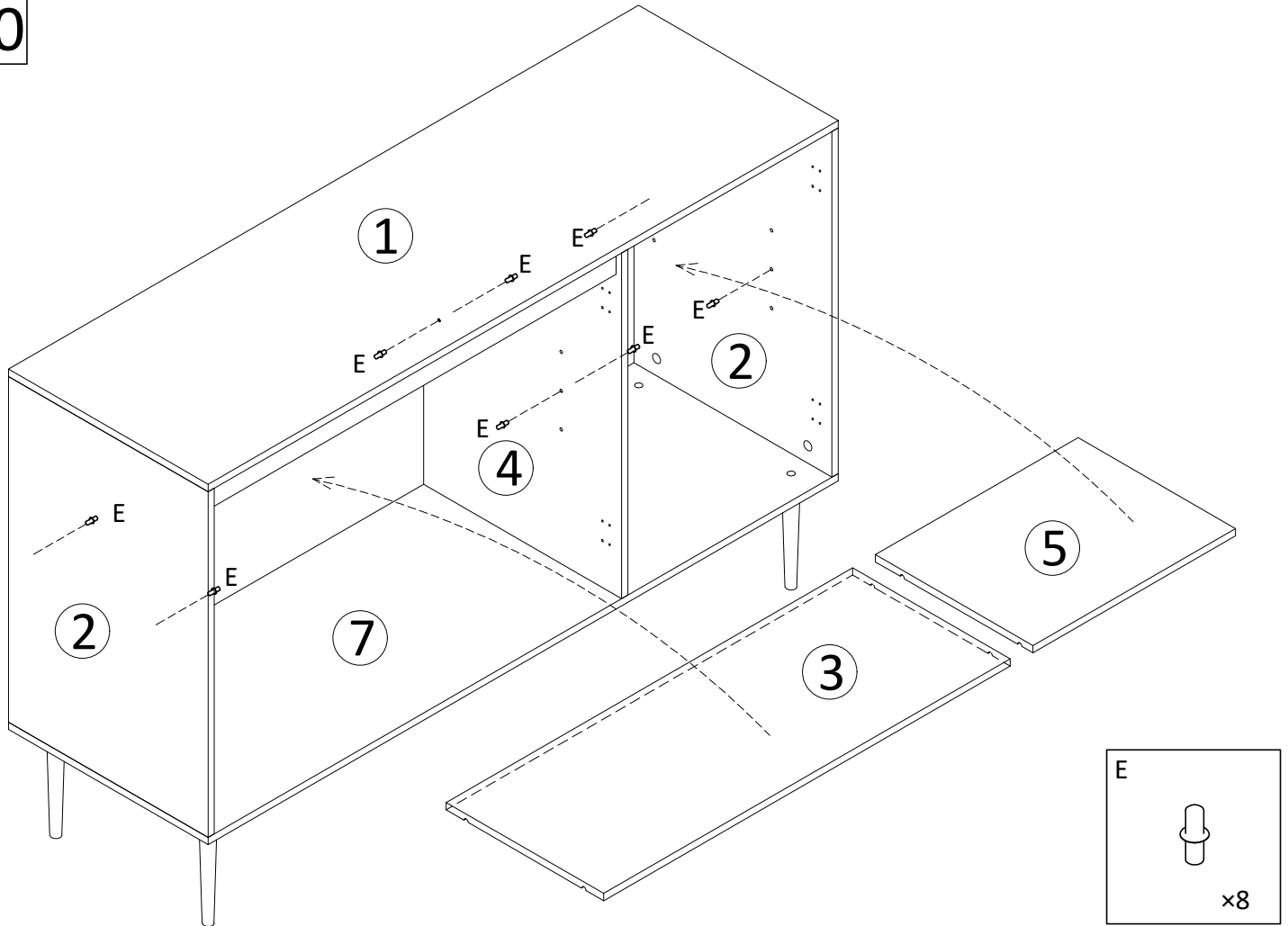

STEP (1)

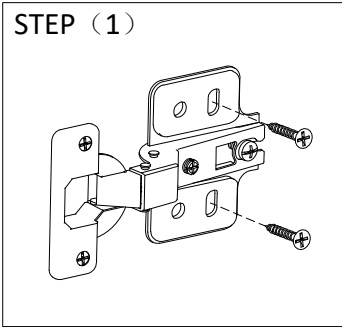

Tips: Turning the screw to approx 50% tightness, don't be fully tight.

STEP (2)

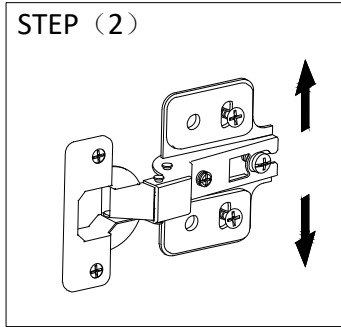

Tips: Moving the hinges up or down appropriately to adjust the gap between the door and cabinet top and bottom.

STEP (3)

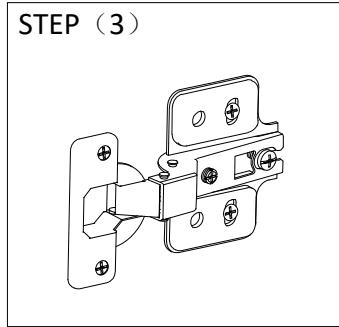

Tips: Tightening the screws completely.

STEP (4)

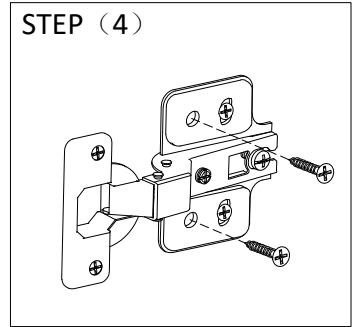

Tips: Tightening the other screws completely.

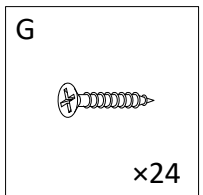
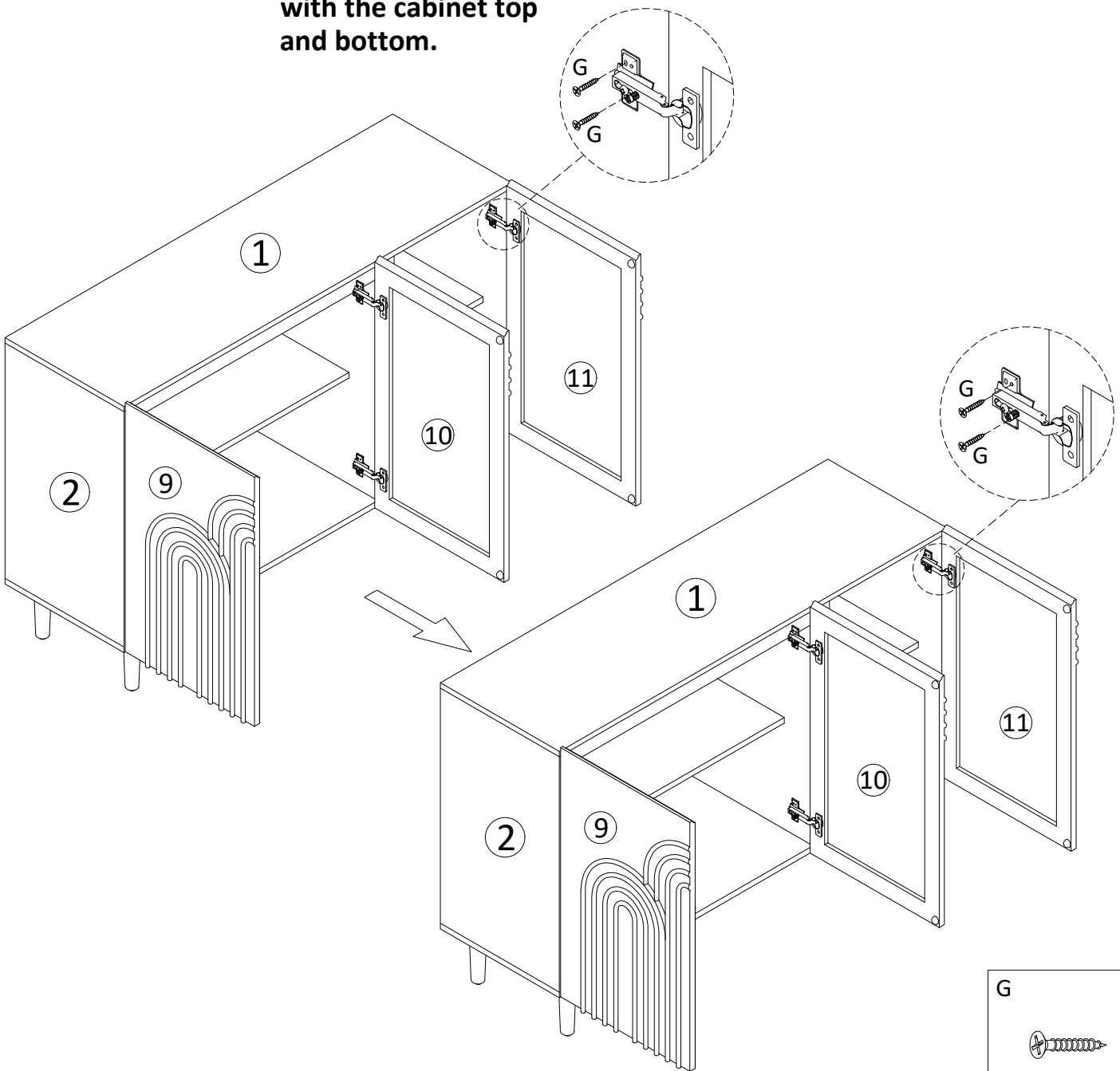

12 Tips: If the gap between two doors is too far or close, please turning the screw as shown below.

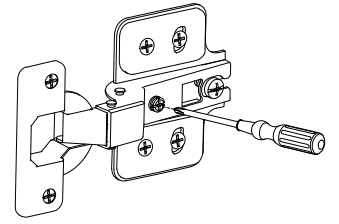
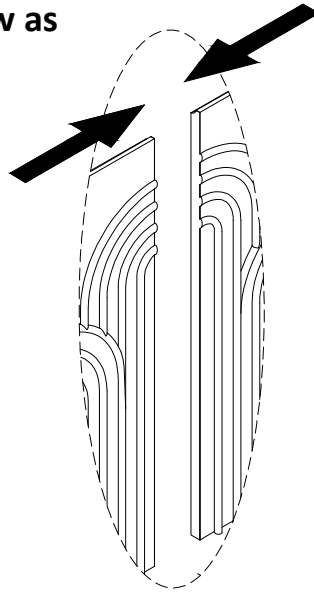
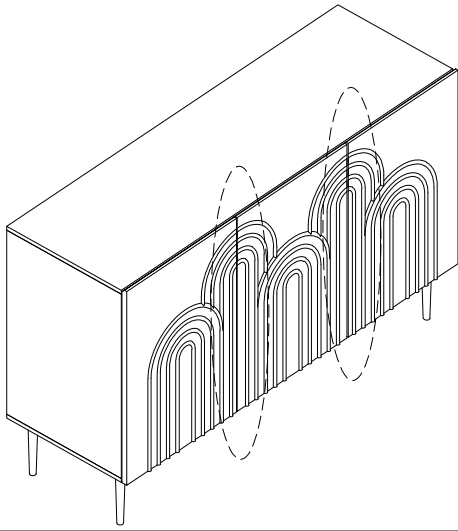

Tips: Adjusting the screw as shown in the following picture can make the door move forward or backward.

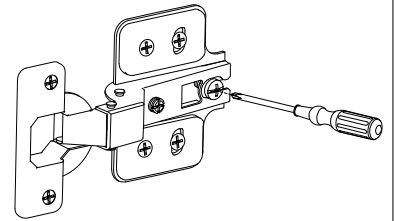
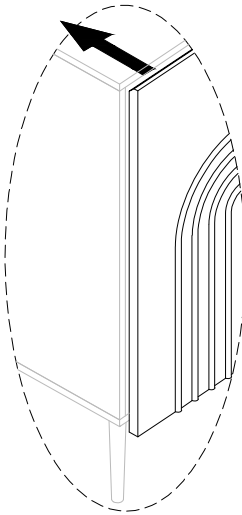
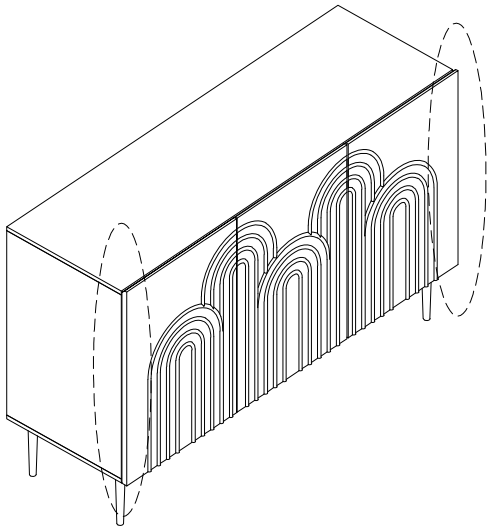

Tips: Adjusting the levelers appropriately underneath the bottom of the foot can make the gaps between the door and frames of cabinet even.

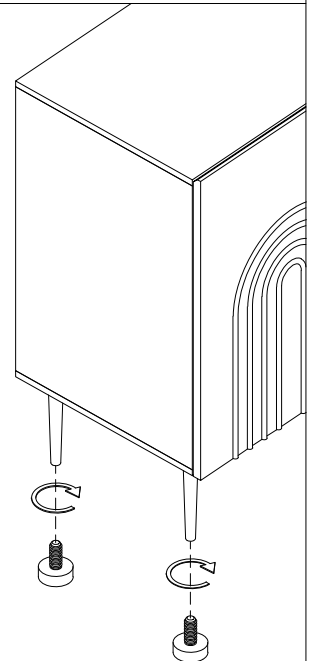
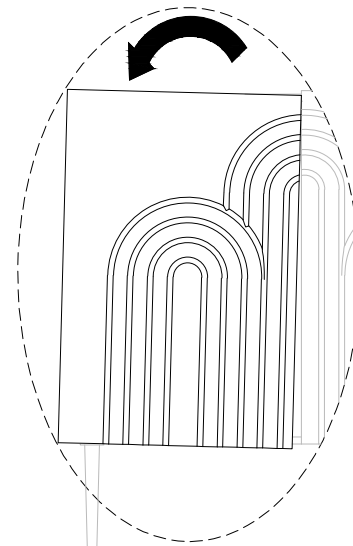
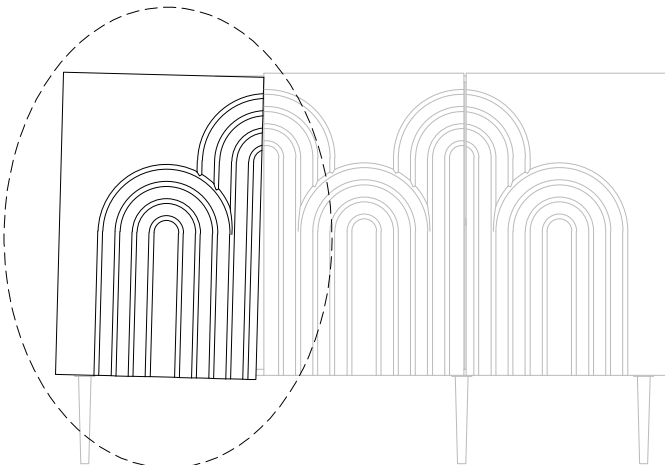

13

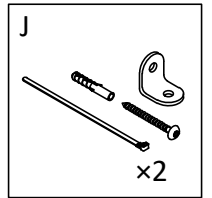
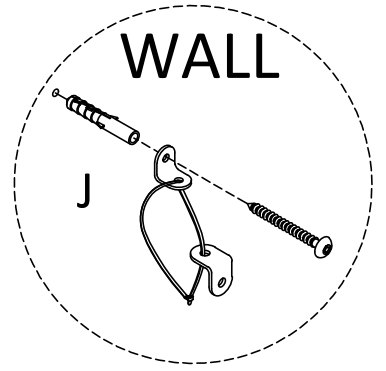
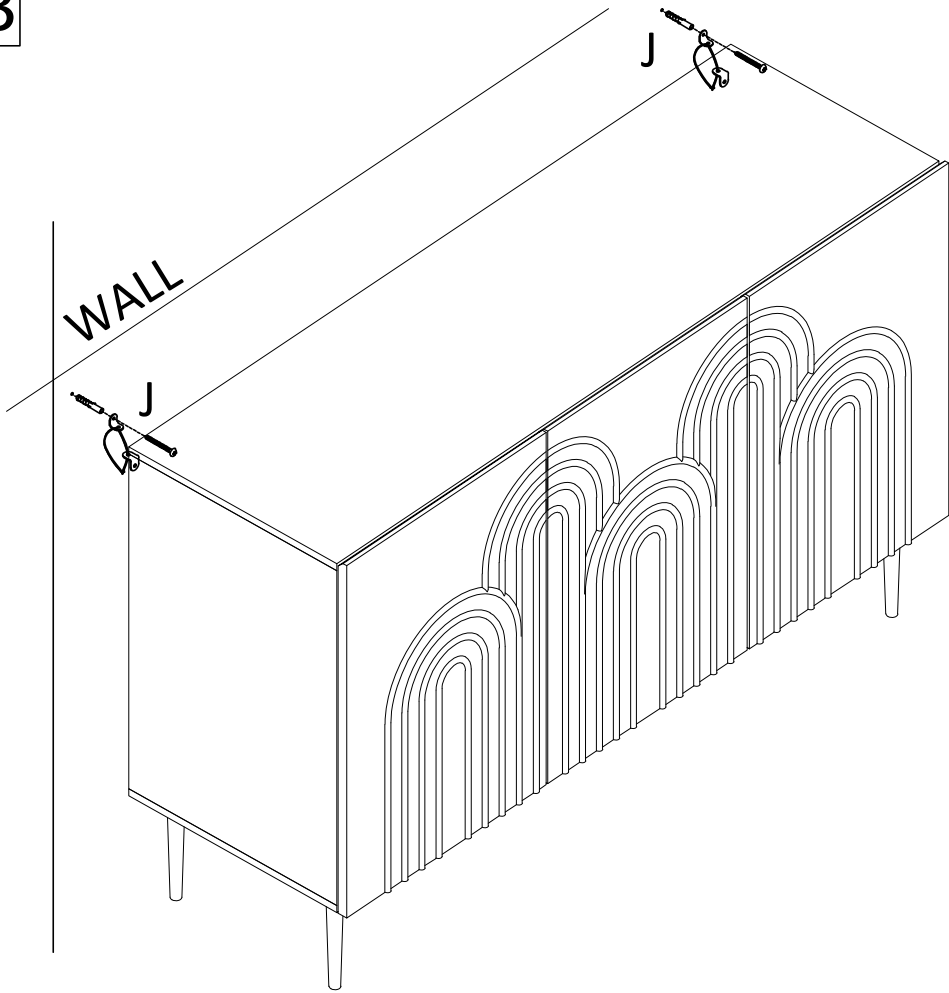

14

