







# ASSEMBLY INSTRUCTIONS & PARTS IDENTIFICATION

## BENCH - GOLDEN

**Thank you for purchasing this quality product. Be sure to check all packing material carefully for small parts that may have come loose inside the carton during shipment**

KeyParts			
No		Qty	Description
1		1pc	Bench Top
2		2pcs	Leg Assembly
3		1pcs	Support Stretcher
4		4pcs	Floor Glide

Hardware kit			
No		Description	Qty
A		Flat washer (Large) For Bracket	8 pcs
B		Flat washer (Small) For Stretcher	2 pcs
C		Lockwasher	10 pcs
D		Bolt 8x25mm - To attach the Bracket	8 pcs
E		Bolt 8x75mm - To attach Support Stretcher	2 pcs
F		Allen Key	1 pcs
G		Metal Corner Bracket	4 pcs

### Step 1

Attach the Support Stretcher to the bench top using a Long Bolt E, Lock Washer C, and Small Flat Washer B. Fully tighten bolts after both bolts are in place.

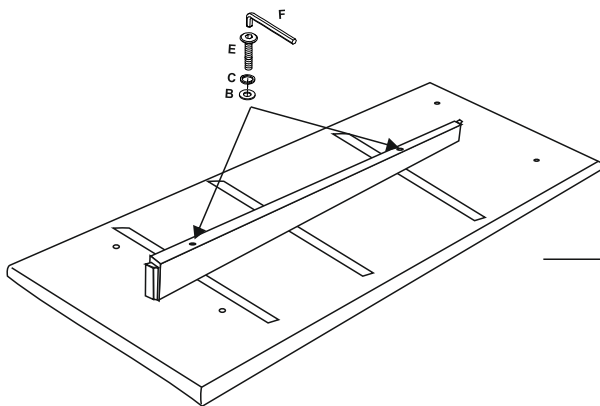

**SETUP REQUIRES 2 PEOPLE**



### Step 2

Attach two Metal Corner Brackets G to the inside of each panel of the Leg Assembly using a Short Bolt D, Lock Washer C, and Large Flat washer A. Do not fully tighten at this point.

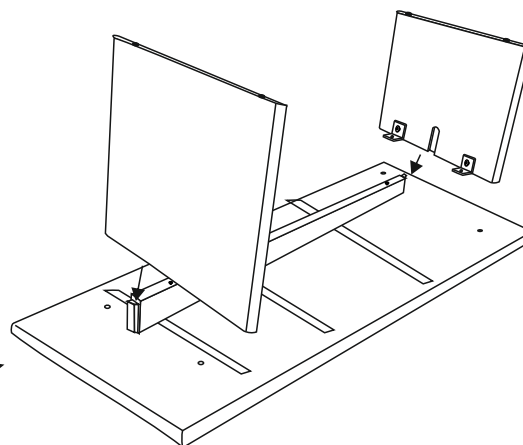
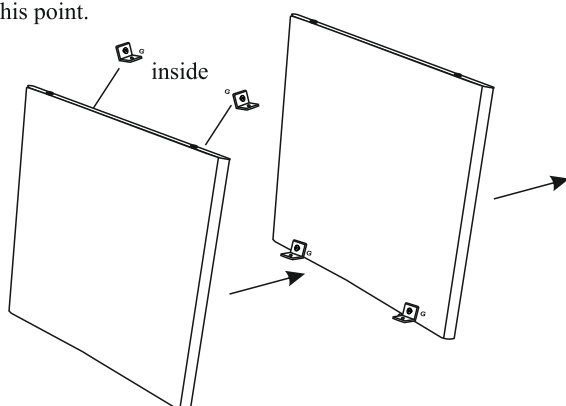

### Step 3







Carefully place the Leg Assembly into place by inserting the notched portion of the inside panel to the receiver on the Support Stretcher. Keep Leg Assembly Panels supported.

# ASSEMBLY INSTRUCTIONS & PARTS IDENTIFICATION

## BENCH - GOLDEN

**Thank you for purchasing this quality product. Be sure to check all packing material carefully for small parts that may have come loose inside the carton during shipment**

KeyParts			
No		Qty	Description
1		1pc	Bench Top
2		2pcs	Leg Assembly
3		1pcs	Support Stretcher
4		4pcs	Floor Glide

Hardware kit			
No		Description	Qty
A		Flat washer (Large) For Bracket	8 pcs
B		Flat washer (Small) For Stretcher	2 pcs
C		Lockwasher	10 pcs
D		Bolt 8x25mm - To attach the Bracket	8 pcs
E		Bolt 8x75mm - To attach Support Stretcher	2 pcs
F		Allen Key	1 pcs
G		Metal Corner Bracket	4 pcs

### **Step 4**

Attach the Metal Corner Bracket to the bench top using a Short Bolt D, Lock Washer C, and Large Flat washer A, leaving the bolts loose at this time. Once all bolts are on place, fully tighten by hand using the provided Allen Key.

**SETUP REQUIRES  
2 PEOPLE**

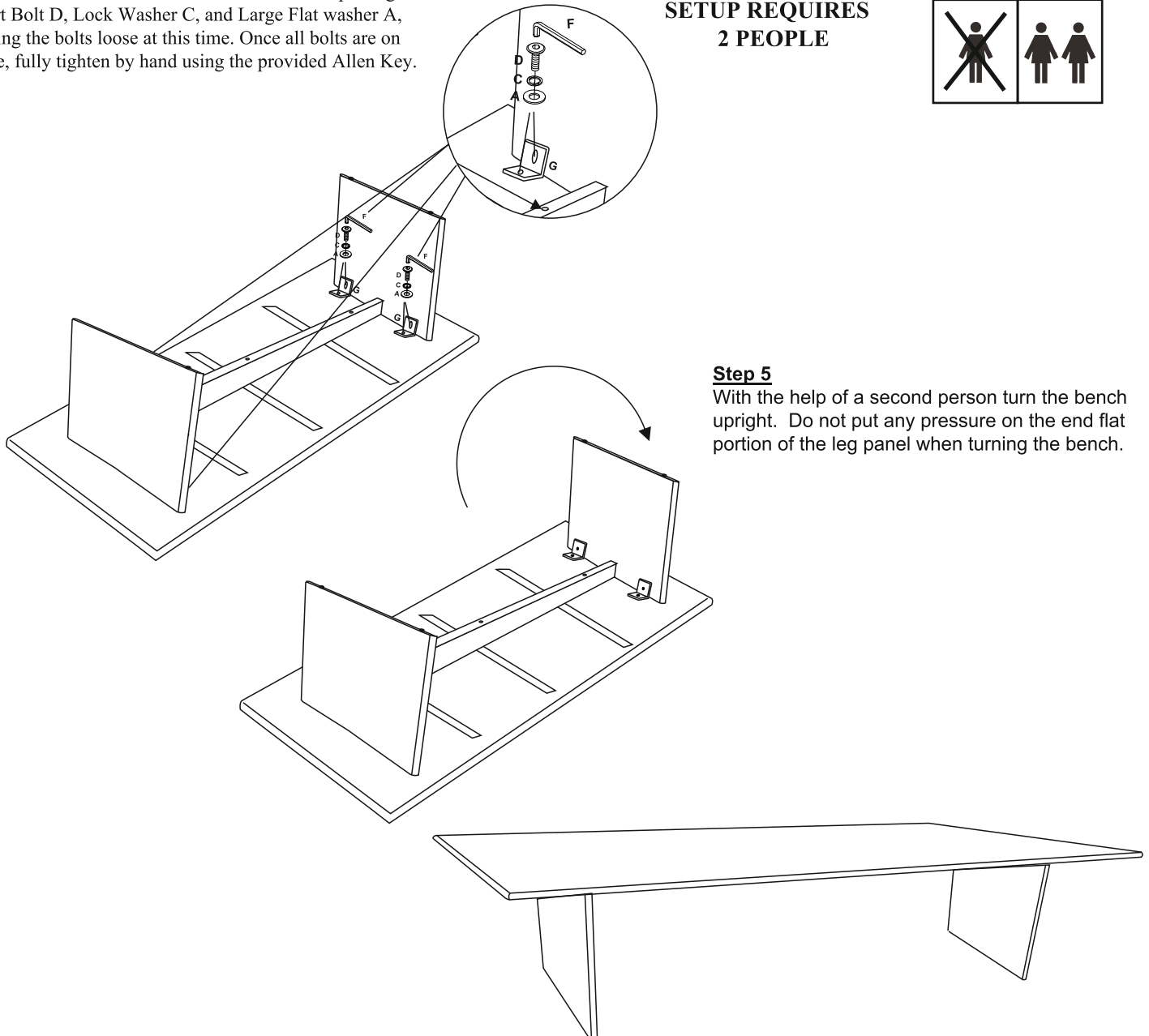

### **Step 5**

With the help of a second person turn the bench upright. Do not put any pressure on the end flat portion of the leg panel when turning the bench.