

Installation instructions for bathroom pendant

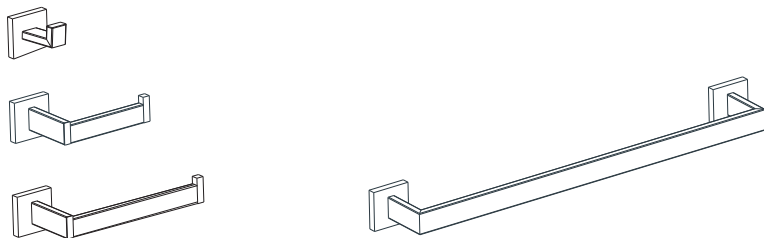

The tools you will use

pencil



Electric drill



screwdriver



Hexagon wrench



Installation steps

A

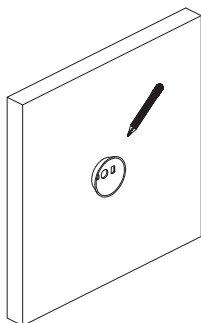

Put the mounting base in the mounting position and draw the position of the opening with pencil

B

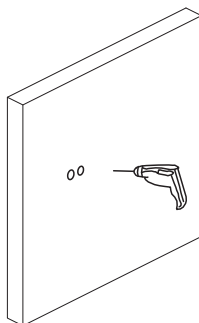

Use an electric drill to open a hole with a diameter of 6mm and a depth of 15-20mm

C

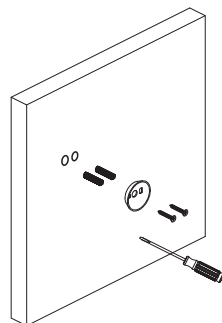

Install the mounting base in the order shown in the diagram

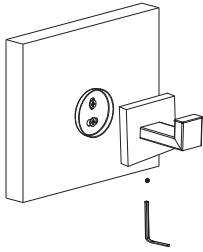

Fix the product body
and mounting base
with screws

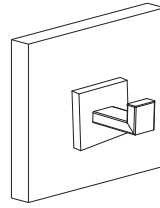

The installation is complete

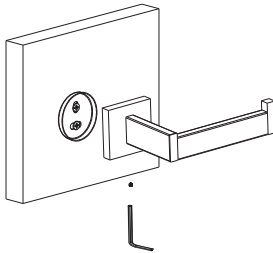

Fix the product body
and mounting base
with screws

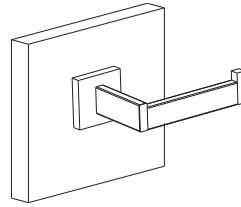

The installation is complete

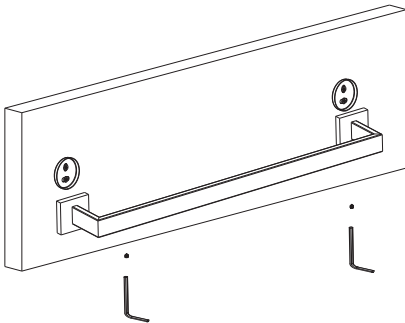

Fix the product body
and mounting base
with screws

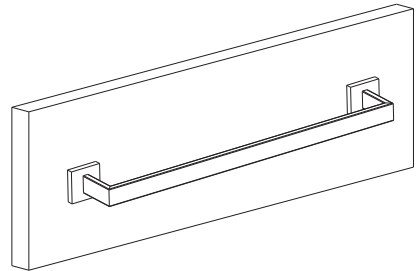

The installation is complete