

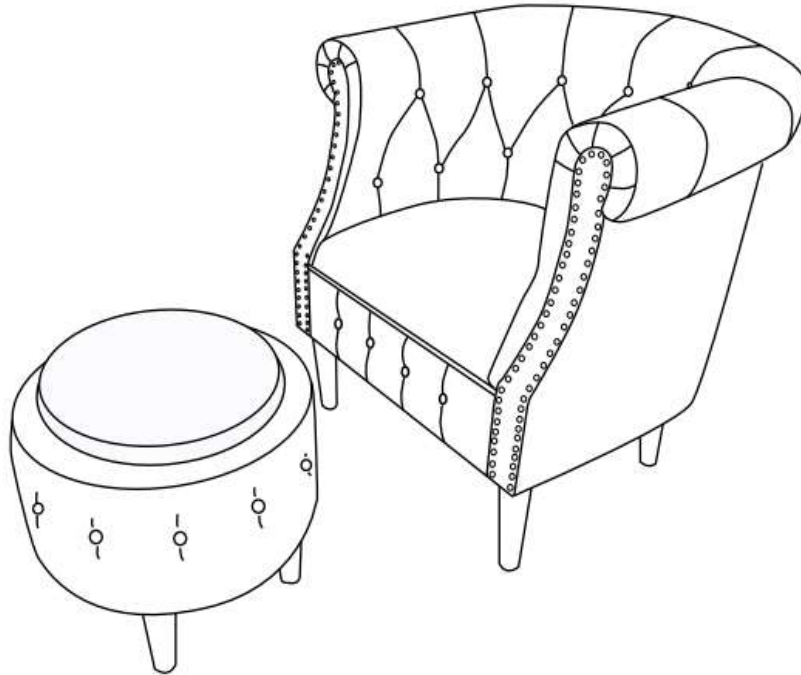



Assembly Instructions

Caution : You must read this before you proceed

CHAIR+OTTOMAN

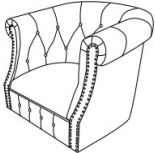

Parts List

Label	Picture	Description	QTY
A		Chair Body	1
B		Ottoman Body	1
C		Ottoman Lid	1
D		Ottoman Leg(Short)	4
E		Chair Leg(Long)	4

Hardware

Label	Picture	Description	QTY
①		Plastic Washer	14

Assembly Preparation

Before Beginning Assembly:

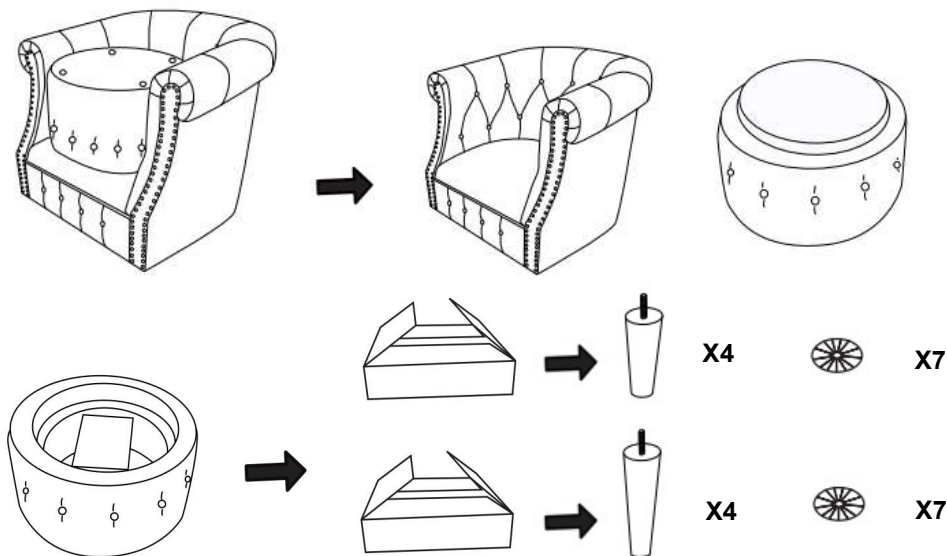

• Read instructions, cover to cover-



• Have 2 adults on hand for assembly-



• Do not assemble on flooring or carpet-



• Assemble on a clean non-marring surface (packing foam)-



• Save all packaging until finished-

Assembly Steps

OVERVIEW

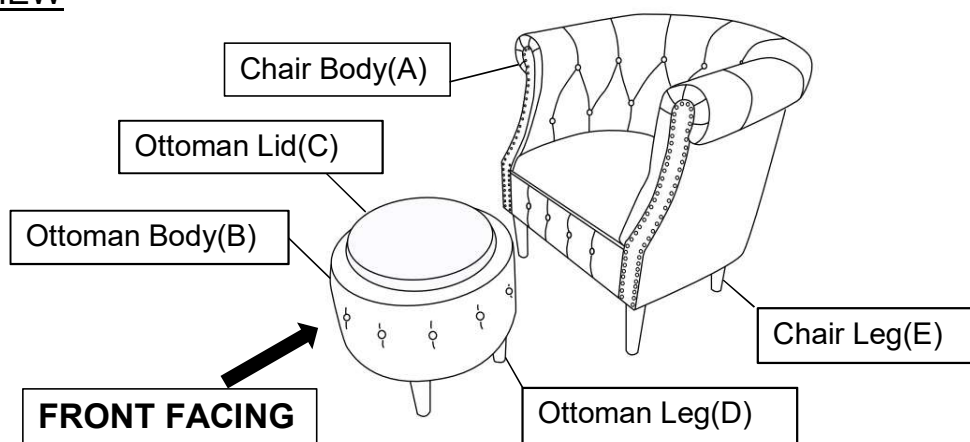

This Chair+Ottoman set has multiple parts and may require up to 30 minutes to assemble. To give you an overview of the Recliner parts, the above picture is to help you put the various Recliner parts into perspective. Please read through the instructions to familiarise yourself with the parts and steps before assembly.

Step 1

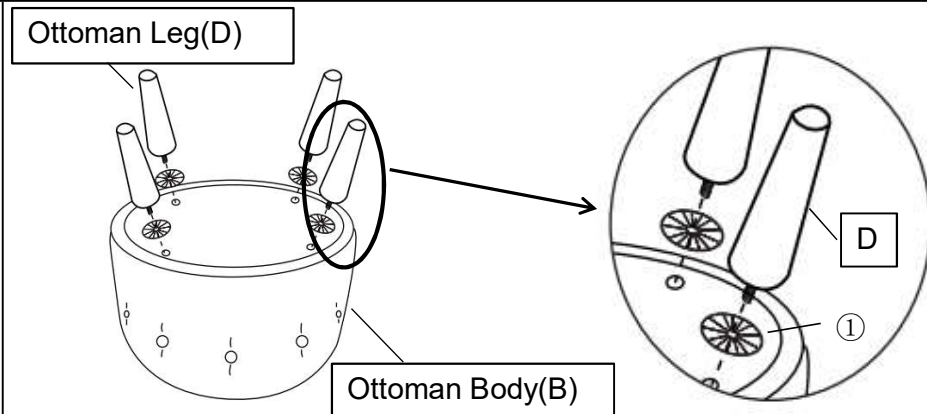

Position Ottoman Body(B) facedown on a clean, non-marring surface. Install the Ottoman Legs(D) into the bottom of the Ottoman Body(B) by placing a Plastic Washer(①) and tighten by turning the leg clockwise. Repeat the same step to install the remaining three legs(D).
Note: The use of Plastic Washer(①) are OPTIONAL and are especially useful to help alleviate slight wobbles. Some Legs may need more than one Plastic Washer whilst some Legs may not need any.
Position Ottoman right side up and test for stability on a Level Surface. Add or remove Plastic Washer(①) where needed to achieve stability.

Step 2

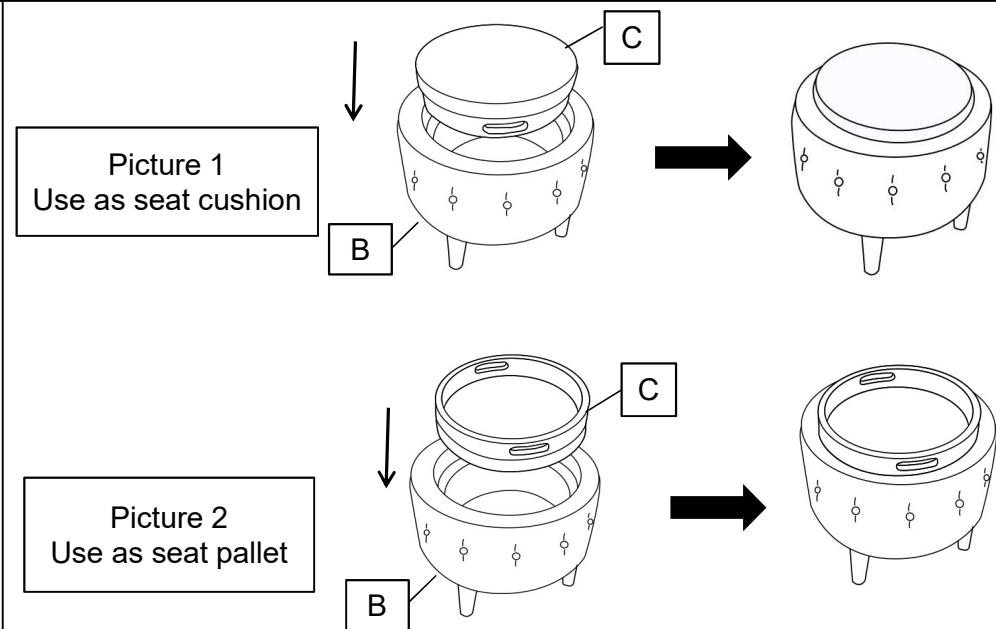

Install the Ottoman Lid(C) into the Ottoman Body(B).
Note:In this step:Ottoman Lid(C) can be used as cushion as picture 1 showed,and also can be used as pallets as picture 2 showed.

Step 3

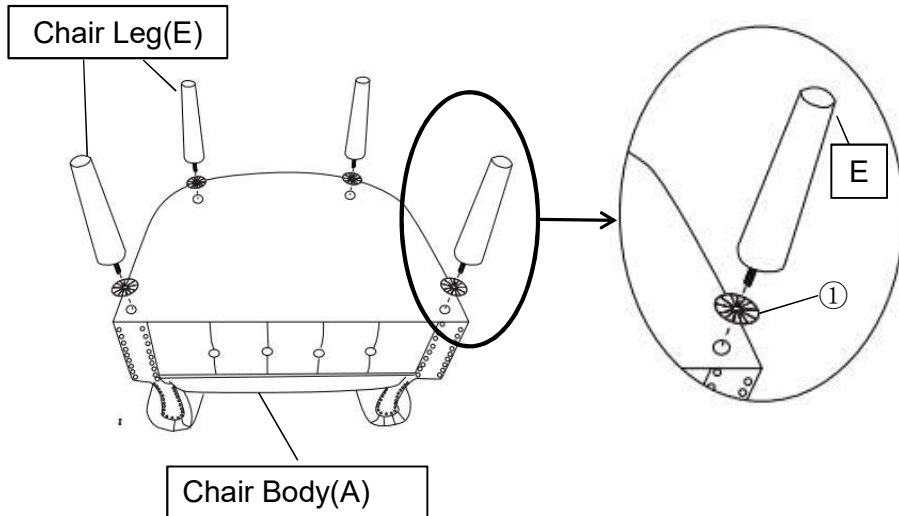

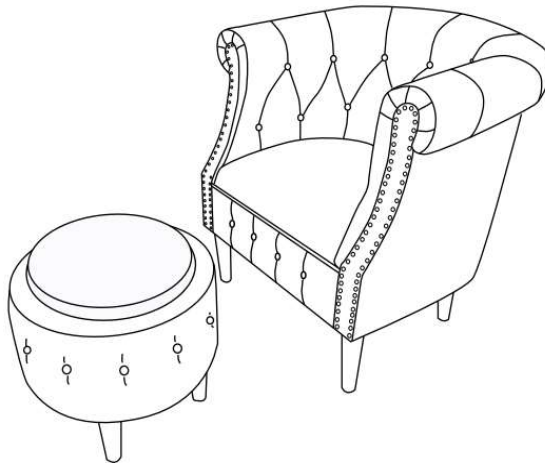

Position Chair Body(A) facedown on a clean, non-marring surface.
Install the Chair Legs(E) into the bottom of the Chair Body(A) by placing a Plastic Washer(①) and tighten by turning the leg clockwise.
Repeat the same step to install the remaining three legs(E).
OPTIONAL and are especially useful to help alleviate slight wobbles. Some Legs may need more than one Plastic Washer whilst some Legs may not need any.
Position Ottoman right side up and test for stability on a Level Surface.
Add or remove Plastic Washer(①) where needed to achieve stability.

Step 4



Your Chair+Ottoman is ready for use now.
Caution :This Chair+Ottoman can only be used on a flat, level surface.

Care & Maintenance

- ⊘  ● Do not put hot items directly on furniture surface
- ⊘  ● Do not clean furniture with harsh cleansers or polish.
- ⊘  ● Do not place furniture under direct sunlight.
- ⊘  ● Do not place furniture near heating or cooling vents.
- ⊘  ● Do not write on furniture without a padded barrier to protect the surface.
- ⊘  ● Do not place furniture outside . For indoor use only .
- ⊘  ● Not for commercial use. For residential use only .
- ⊘  ● Stains may be removed with mild soap solution and damp cloth.
- ⊘  ● Children should not climb or jump on the furniture.

-
- ✓  ● Dust and pick-up spills using a clean, non-colored, lint-free cloth .