

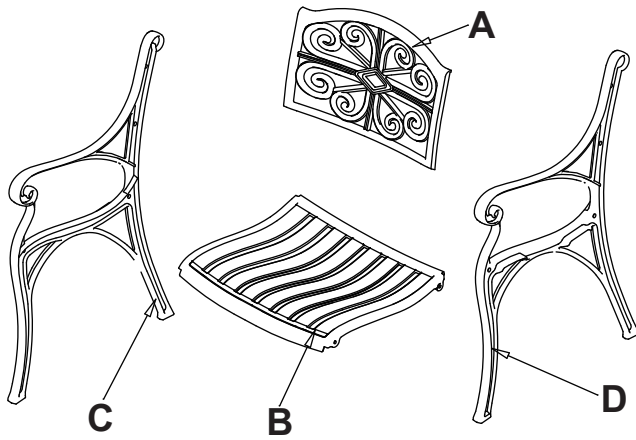

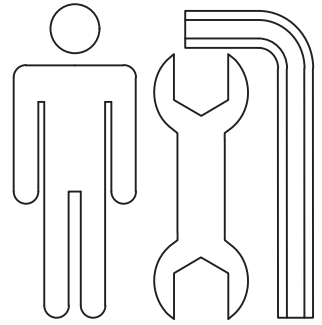







# INSTRUCTION MANUAL



**Cast Aluminum Dining Armchair**



Note: The 2 armrests (C&D) are universal.

Part Number	Images and Sizes	Qty.
A		1
B		1
C		1
D		1
E	 M8*25	4
F	 M8*15	4
I	 M8	4
J	 M8	4
G	 M8*16	4
H	 M8*12	4

## ASSEMBLY INSTRUCTIONS



### CAVEAT

Note: Please only tighten any bolts once all bolts are placed correctly and the product is lying flat. If you tighten one bolt, it may cause other bolts to get out of position.

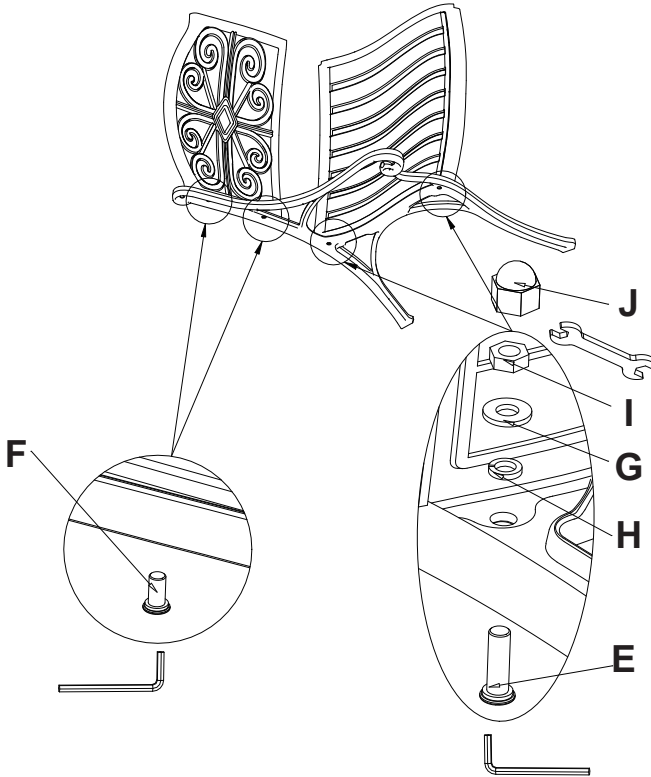

### STEP 1

Attach the back frame (A) to the armrest (C/D) with 2 bolts (F).

Attach the back frame (A) to the seat frame (B) with 2 bolts (E), 2 spring washers (H), 2 washers (G) and 2 nuts (I). Do not over-tighten them.

## ASSEMBLY INSTRUCTIONS



### CAVEAT

Note: Please only tighten any bolts once all bolts are placed correctly and the product is lying flat. If you tighten one bolt, it may cause other bolts to get out of position.

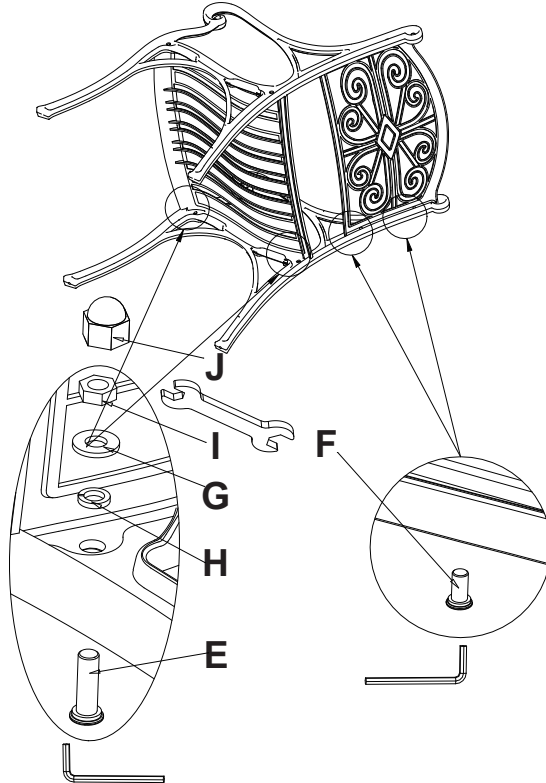

### STEP 2

Attach the back frame (A) to the armrest (C/D) using 2 bolts (F).

Fasten the back frame (A) to the seat frame (B) with 2 bolts (E), 2 spring washers (H), 2 washers (G) and 2 nuts (I). Do not over-tighten them.

Upon completing the entire assembly and bolting up, you can tighten all the screws and put on the protective caps (J).

## **CARE AND MAINTENANCE**

Follow the instructions for the product's material to ensure it stays in the best shape as long as possible. The information below is a general guideline.

Don't hesitate to get in touch with us to learn more.





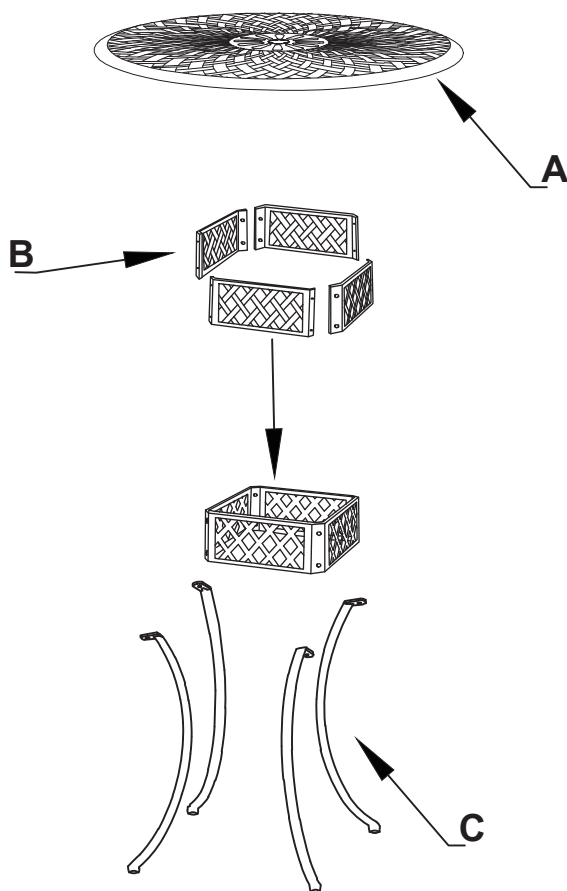
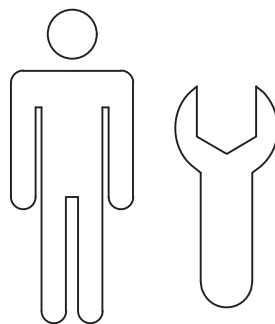

- Only rinse it thoroughly with clean water to wash away dirt and grime. Never use abrasive cleansers on the furniture since they can attack the surface and leave behind scratch marks.
- For stubborn grime and stains, use a soft sponge and mild soapy water. Then dry it with a cloth or paper towel.
- Check the stability of the screws, nuts, and nut caps before each use. Then, tighten them up after one to two months' use whenever required.
- Avoid improper use, and be careful not to scratch or damage the surface with sharp objects.
- When you move your furniture, lift it rather than pulling or pushing it to avoid damaging the floor, legs, and mounting.

# INSTRUCTION MANUAL



**Cast Aluminum Round Dining Table**



Part Number	Images and Sizes	Qty.
A		1
B		4
C		4
D	 M8* $\phi$ 18	12
E	 M8* $\phi$ 12	12
F	 M8	12
G	 M8	12

## ASSEMBLY INSTRUCTIONS



### CAVEAT

Note: Please only tighten any bolt once all bolts are placed correctly. If you tighten one bolt, it may cause other bolts to get out of position.

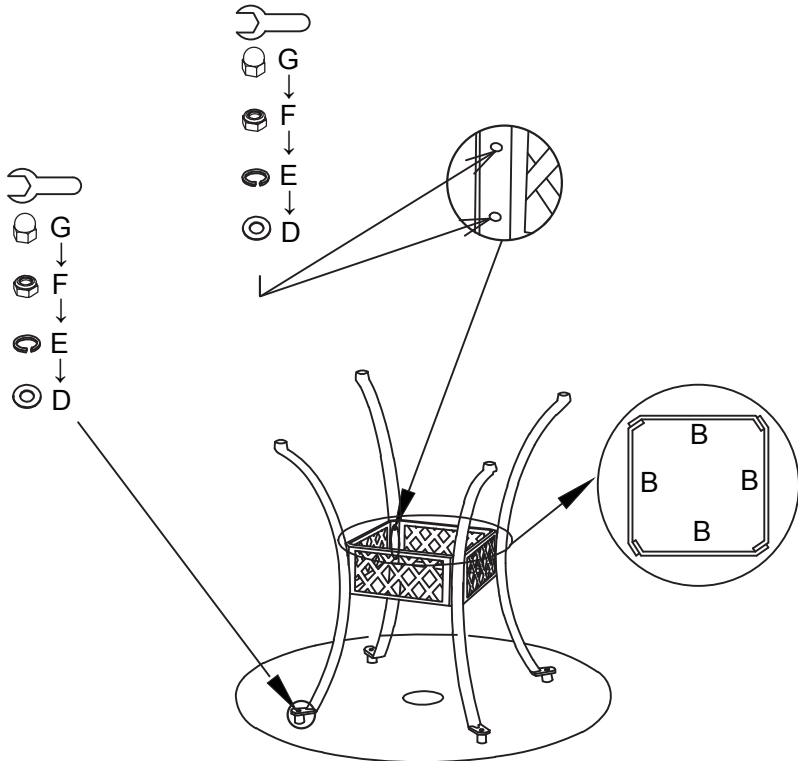

### STEP 1

Attach Table top (A) to 4 legs (C) using , 1 washer (D) , 1 spring washer (E) and 1 nut (F) respectively. Do not over tighten.

Attach legs (C) to legs' support (B) using 2 washers (D), 2 spring washers (E) and 2 nuts (F) respectively. Do not over tighten.

Tighten all screws and finally fasten the nut cap (G).

## **CARE AND MAINTENANCE**

Follow the instructions for the product's material to ensure it stays in the best shape as long as possible. The information below is a general guideline.

Don't hesitate to get in touch with us to learn more.

- Only rinse it thoroughly with clean water to wash away dirt and grime. Never use abrasive cleansers on the furniture since they can attack the surface and leave behind scratch marks.
- For stubborn grime and stains, use a soft sponge and mild soapy water. Then dry it with a cloth or paper towel.
- Check the stability of the screws, nuts, and nut caps before each use. Then, tighten them up after one to two months' use whenever required.
- Avoid improper use, and be careful not to scratch or damage the surface with sharp objects.
- When you move your furniture, lift it rather than pulling or pushing it to avoid damaging the floor, legs, and mounting.