

A

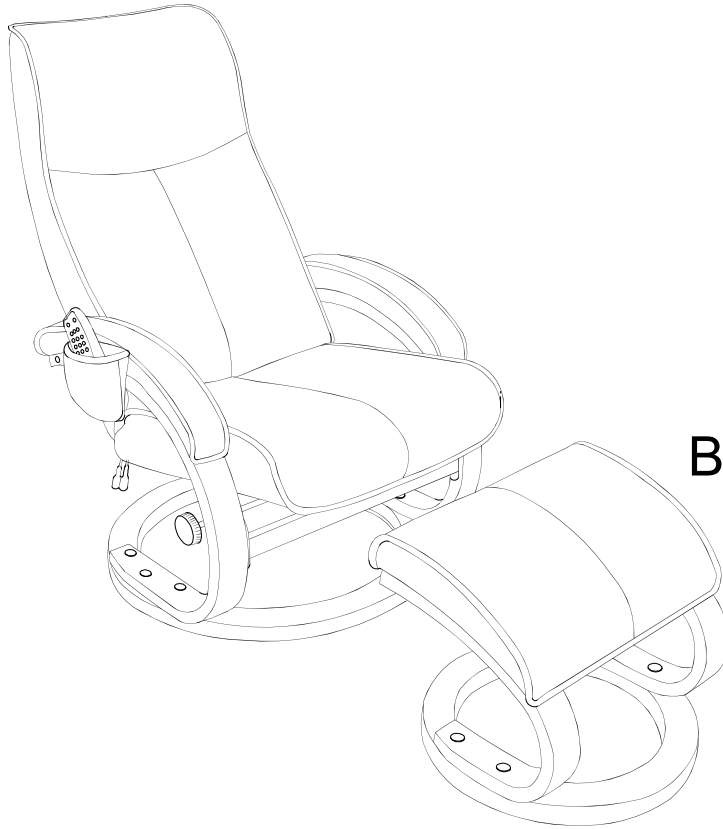

B

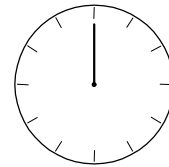

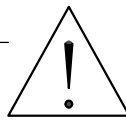
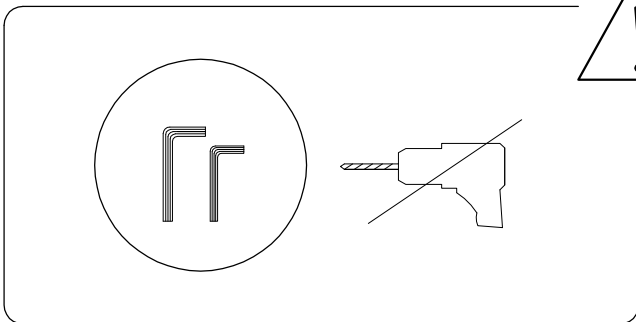

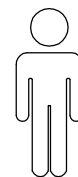
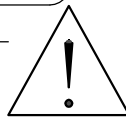
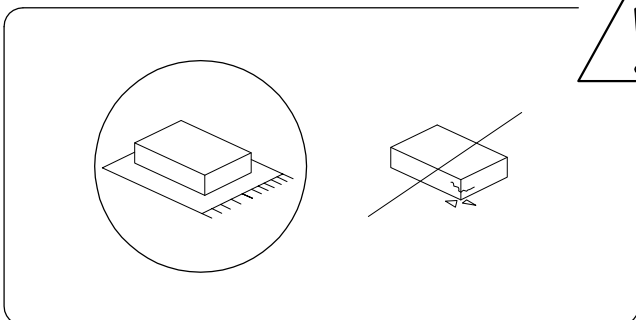
60





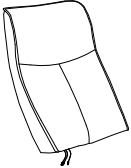

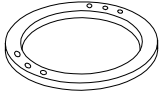
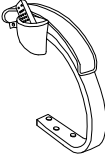
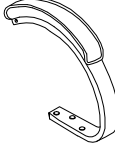
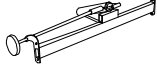

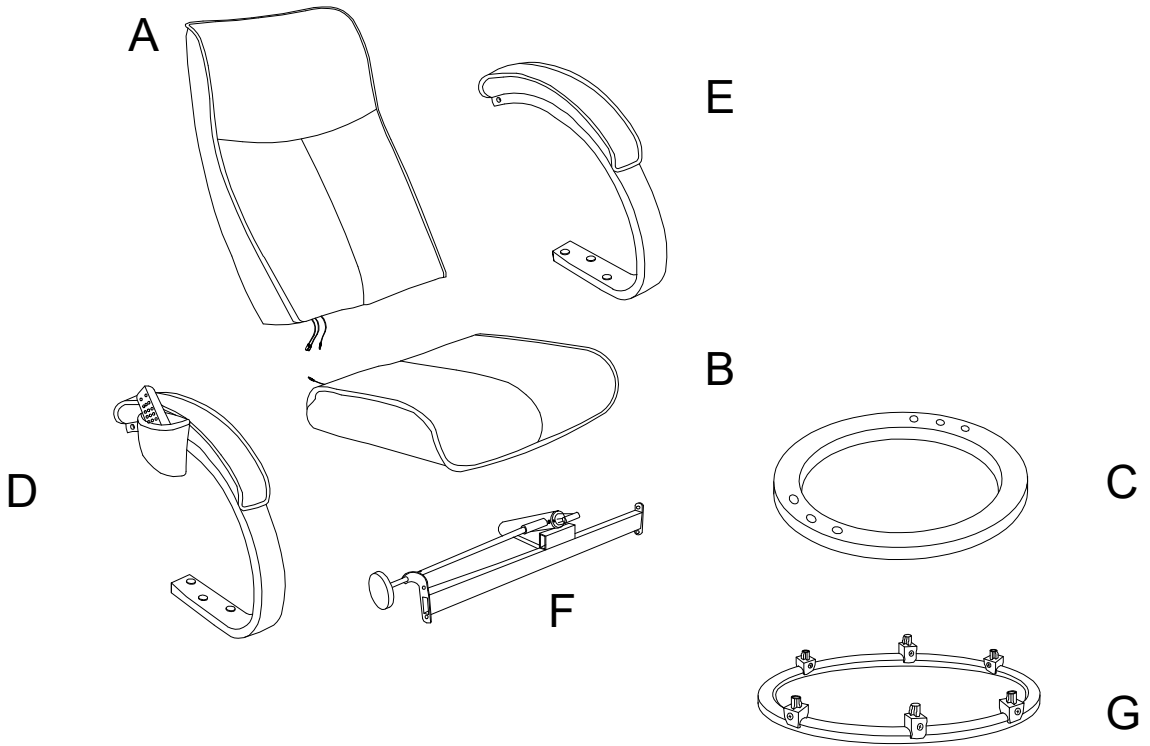
1

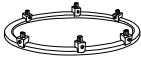

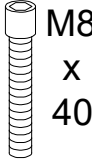

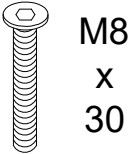
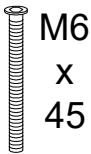
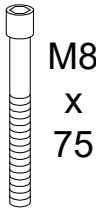
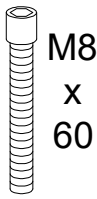

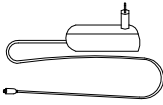
A

A	B	C	D	E	F
					
x 1	x 1	x 1	x 1	x 1	x 1

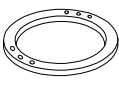

G	H	I	J	K	L
	 M6	 M8	 M8 x 40		 M8 x 30
x 1	x 1	x 1	x 6	x 6	x 2
M	N	O	P	R	S
 M6 x 45	 M8 x 75	 M8 x 60	 M8		
x 4	x 2	x 1	x 3	x 1	x 1

1

C  x 1	D  x 1	E  x 1	I  M8 x 1	J  M8 x 40 x 6	K  x 6
--	--	--	--	--	--

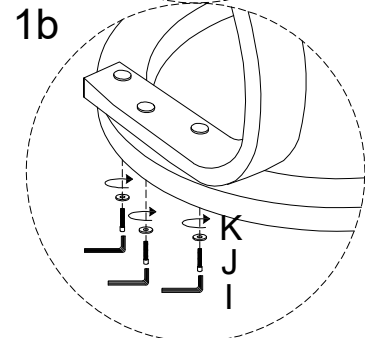
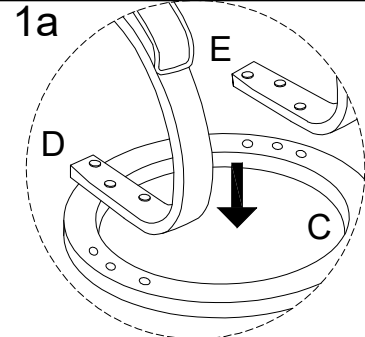
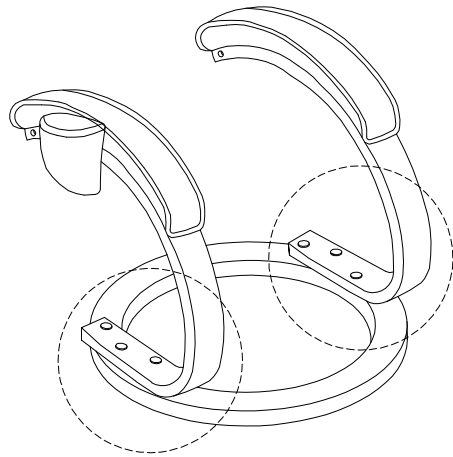

2

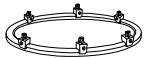
G  x 1
--

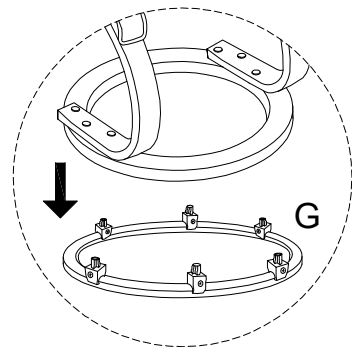
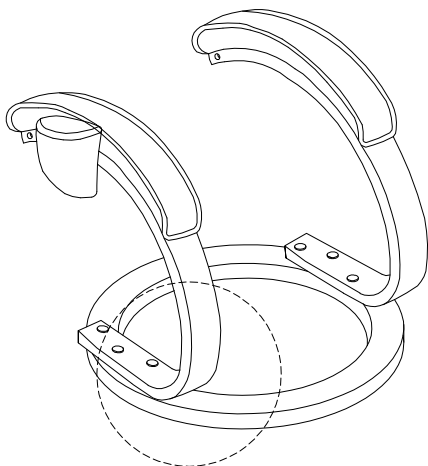

3

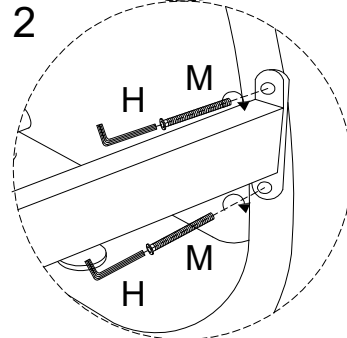
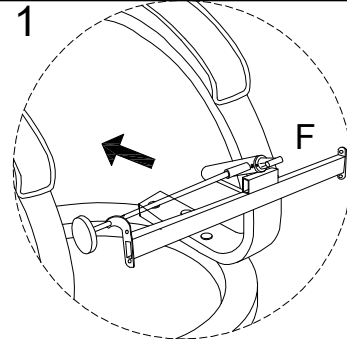
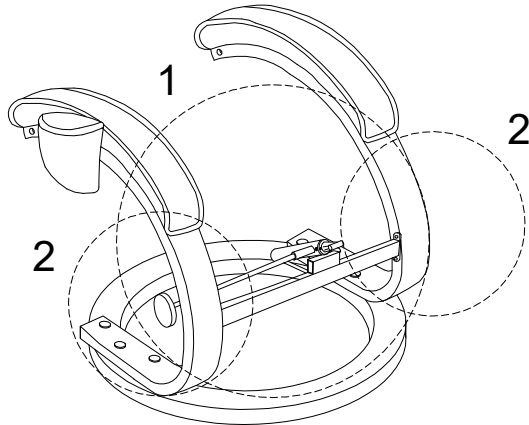
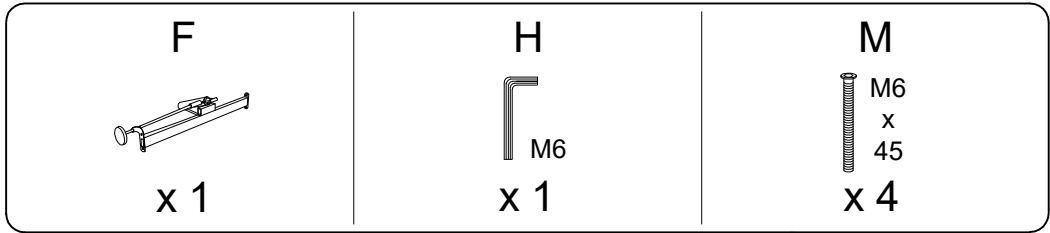

4

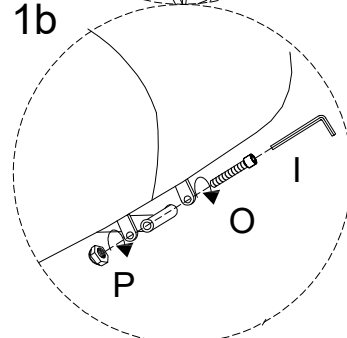
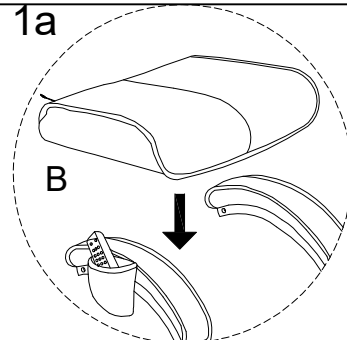
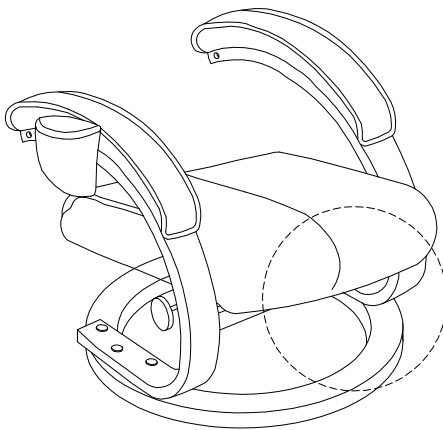
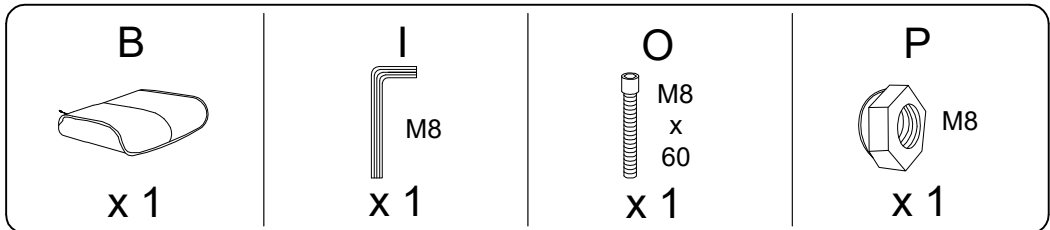

5

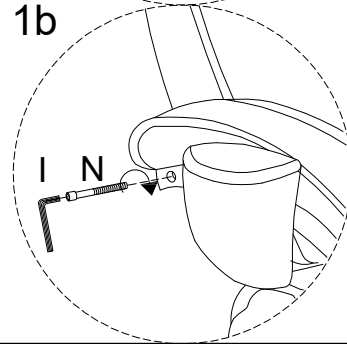
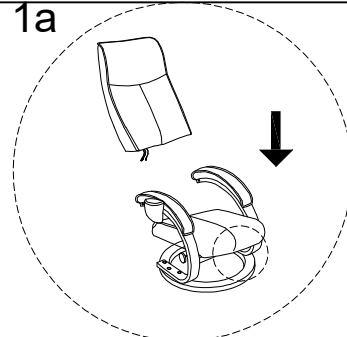
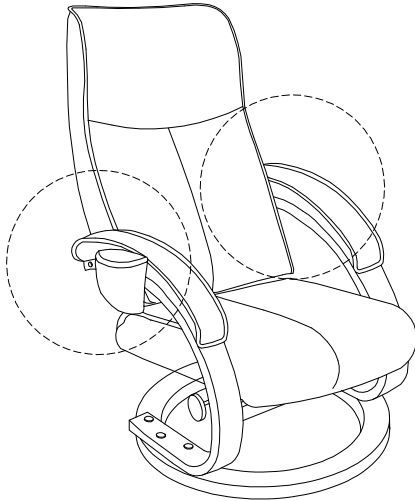
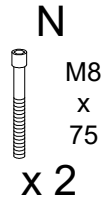
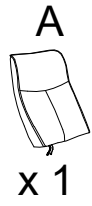

6

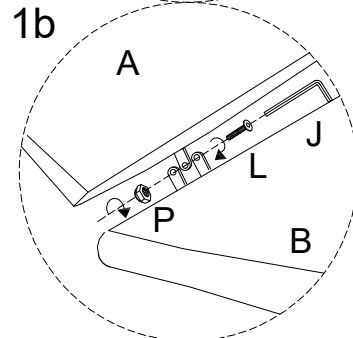
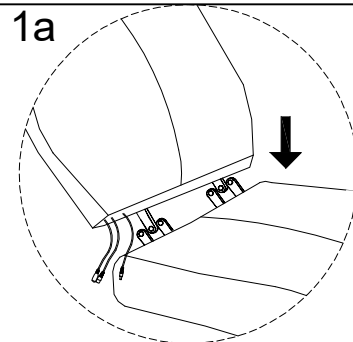
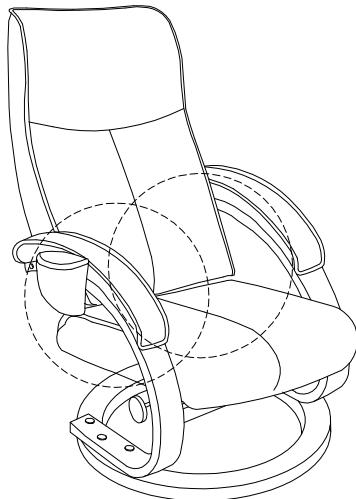
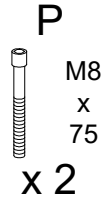
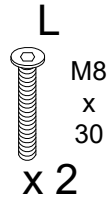

7

R

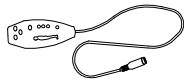

x 1

S

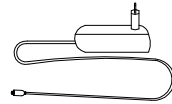



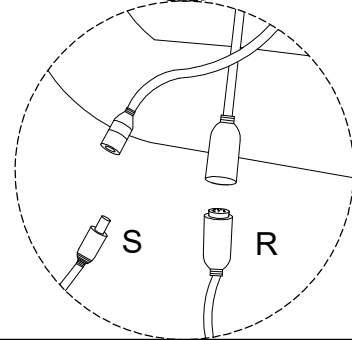
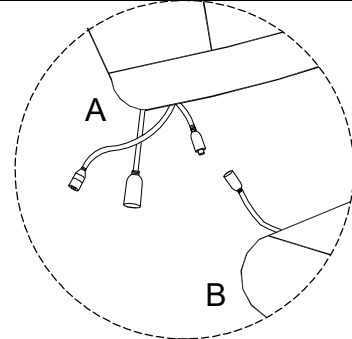
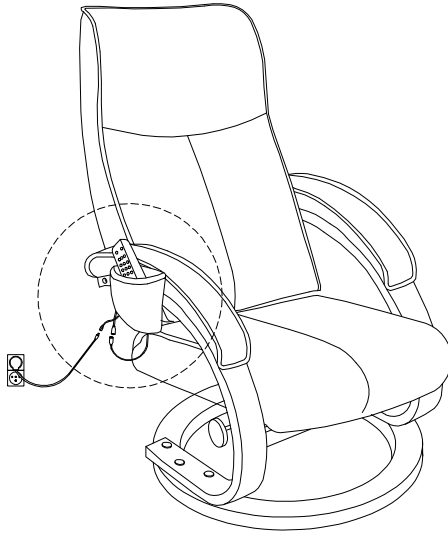

x 1

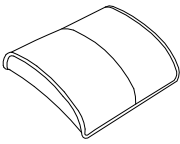
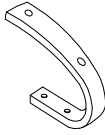
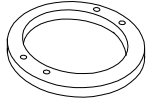

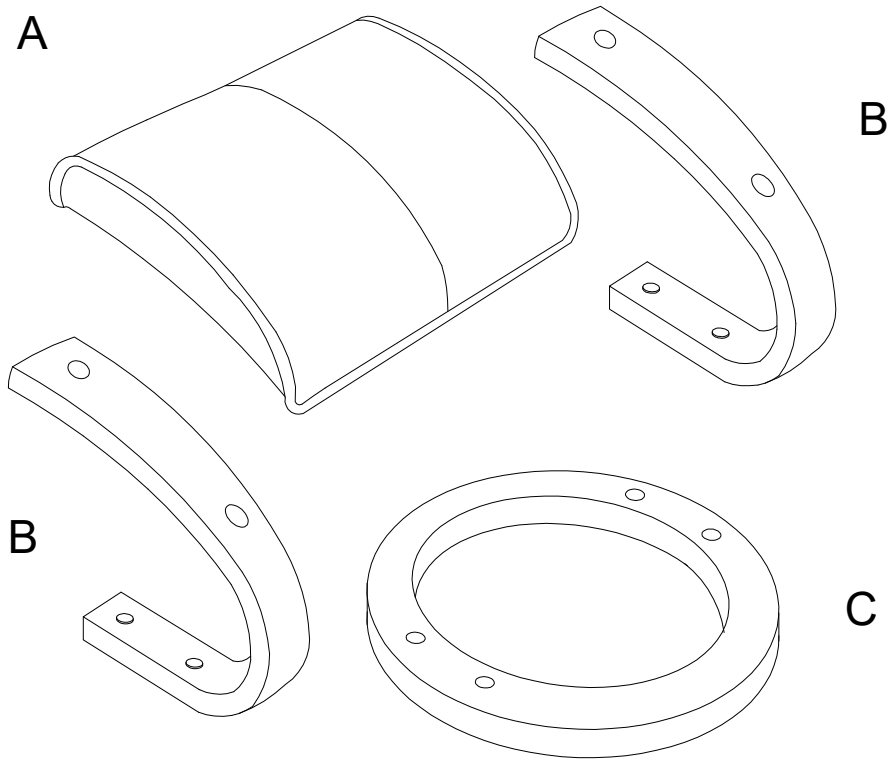

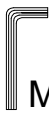

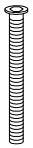
B

<p>A</p>  <p>x 1</p>	<p>B</p>  <p>x 2</p>	<p>C</p>  <p>x 1</p>
---	---	---



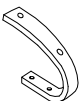
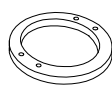

<p>D</p>  <p>M6</p> <p>x 1</p>	<p>E</p>  <p>M8</p> <p>x 1</p>	<p>F</p>  <p>M8 x 40</p> <p>x 4</p>	<p>G</p>  <p>M6 x 40</p> <p>x 4</p>	<p>H</p>  <p>x 4</p>
---	---	--	--	---

1

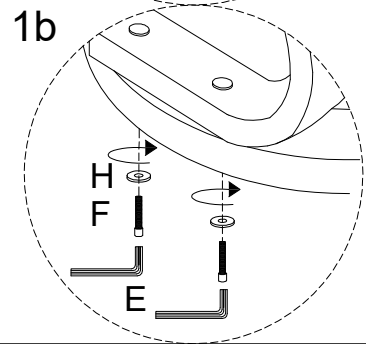
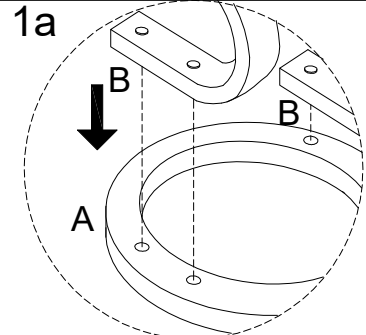
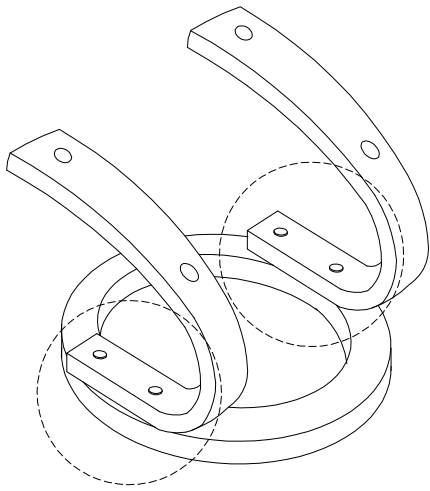
B  x 2	C  x 1	E  M8 x 1	F  M8 x 40 x 4	H  x 4
--	--	--	--	--

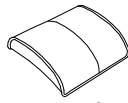

2

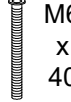
A  x 1	E  M6 x 1	G  M6 x 40 x 4
--	--	--

