

Assembly Instruction

ASSEMBLY TIPS:



1. Remove hardware from box and sort by size.
2. Please check to see that all hardware and parts are present prior to start of assembly.
3. Please follow attached instructions in the same sequence as numbered to assure fast & easy assembly.

Warning !



1. Don't attempt to repair or modify parts that are broken or defective. Please contact the store immediately.
2. This product is for home use only and not intended for commercial establishment.

ASSEMBLY TIME PER UNIT : 10 MINUTES

PARTS IDENTIFICATION:

A.	CABINET		1PC
B.	LEG		4PC
C.	ADJUSTABLE SHELF		2PC

HARDWARE PACKAGE:

ITEM	DESCRIPTION	SKETCH	GAUGE	QTY
1	allen key		4mm	1PCS
2	allen screw		M6*45	8PCS
3	meson		Ø6*16*1.2	8PCS

STEP: 1

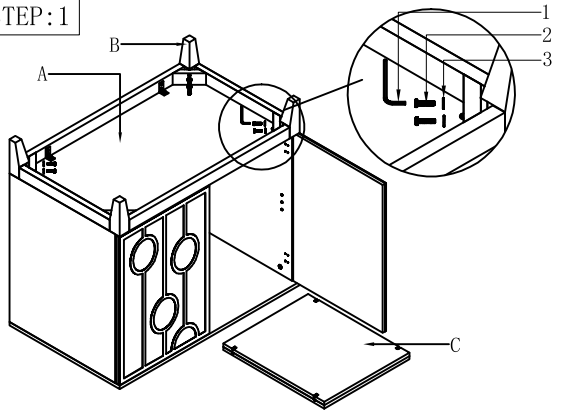

Remove laminate and install foot

STEP: 2

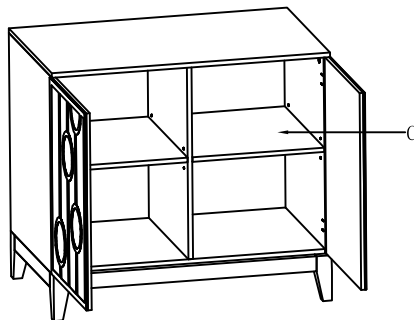

Put the adjustable shelf up.

FINISH

The mirror part provided in this package is not a tempered mirror.
Please handle with care. Mirror part may explode.

