

Assembly Instructions

Caution : You must read this before you proceed

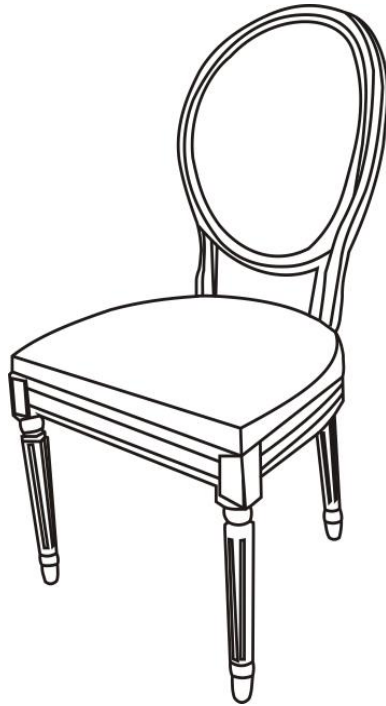



Chair



Parts List

Label	Picture	Description	Qty
A	A line drawing showing the backrest and the two rear legs of the chair, including the seat attachment points.	Back with Legs	1
B	A line drawing of the square seat of the chair, showing its shape and a small notch on one side.	Seat	1
C	A line drawing of a single front leg of the chair, showing its tapered shape and decorative cap.	Front Leg	2

Hardware

Label	Picture	Description	Qty
①		Bolt (M8*60mm)	10
②		Spring Washer (M8)	10
③		Washer (M8)	10
④		Allen Key	1

Assembly Preparation

Before Beginning Assembly:

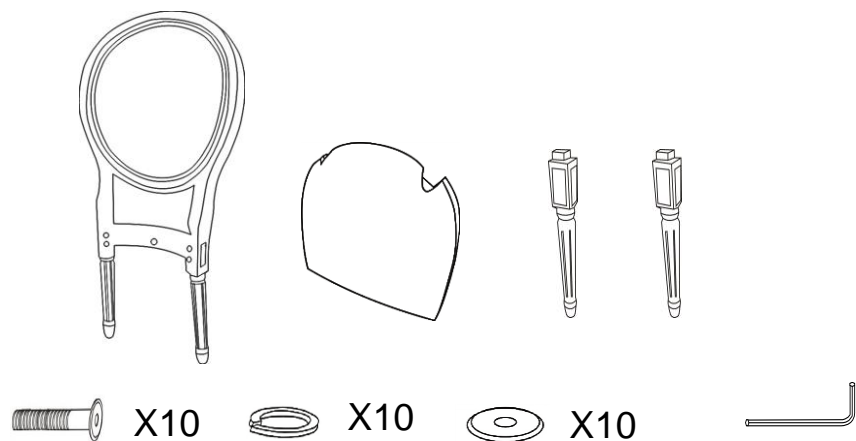

- Read instructions, cover to cover-



- Have 2 adults on hand for assembly-



- Do not assemble on flooring or carpet-



- Assemble on a clean non-marring surface (packing foam)-



- Save all packaging until finished-

Assembly Steps

Overview

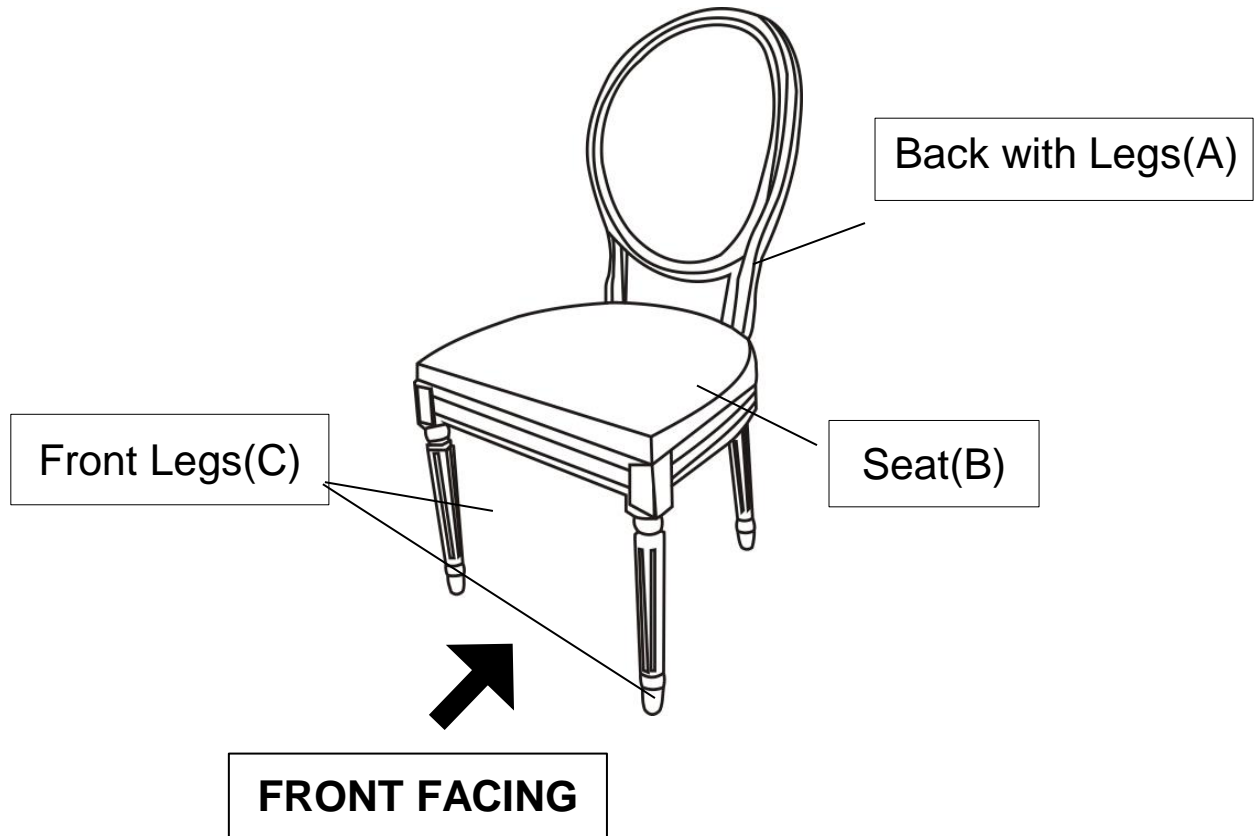

This Dining Chair has multiple parts and may require up to 30 minutes to assemble.

To give you an overview of the Dining Chair parts, the above picture is to help you put the various parts into perspective.

Please read through the instructions below to familiarise yourself with the parts and steps before assembly.

Step 1

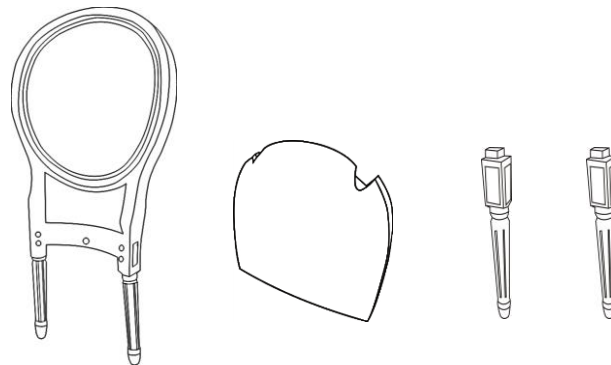

Place all parts on a clean, non-marring surface.

Step 2

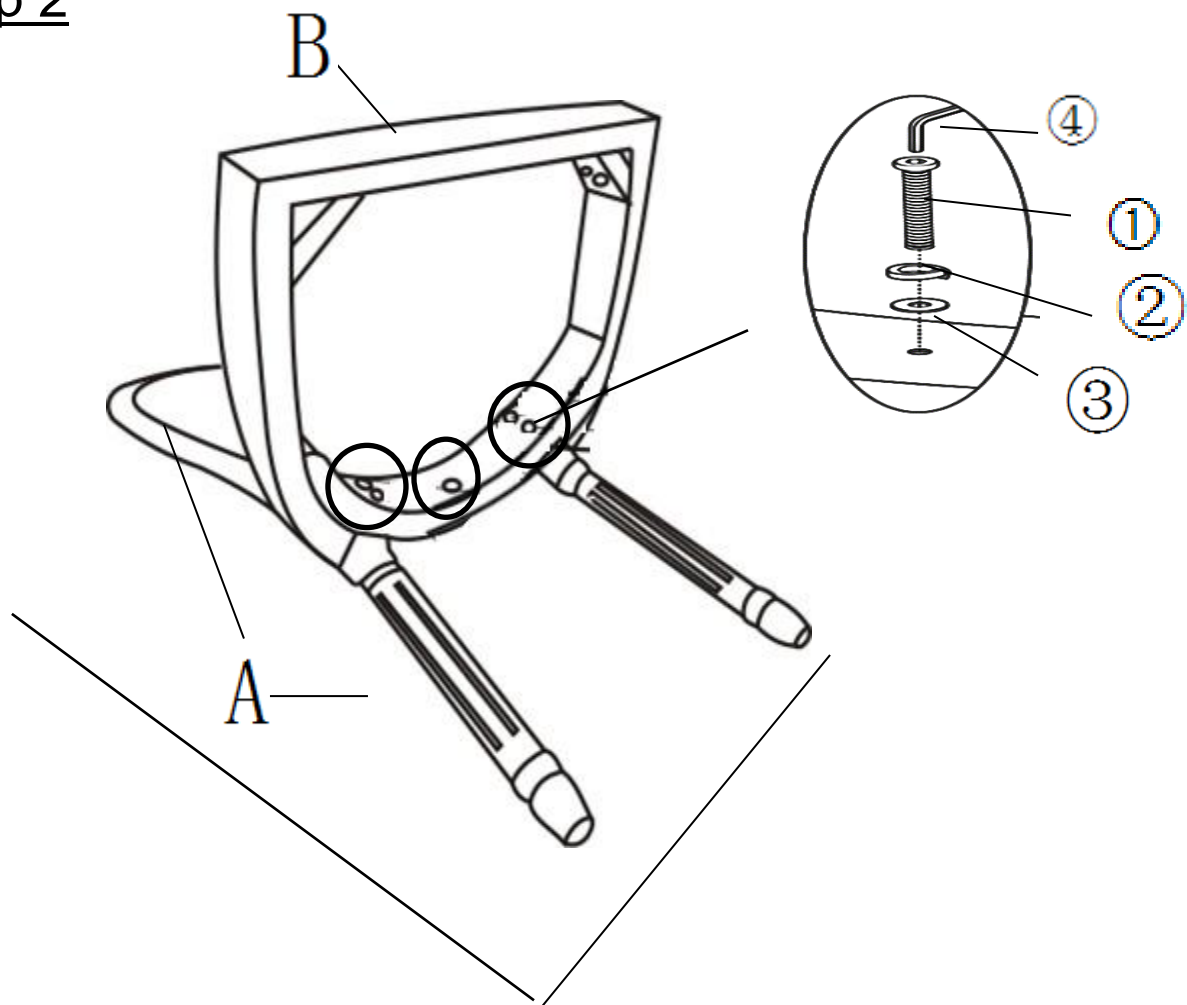

Place the Back with Legs(A) on a clean, non-marring surface. Align the mounting positions on the Seat(B) to the mountings on the Back with Legs(A).

Then attach using Bolts(①), Spring Washers(②) and Washers(③) with Allen Key(④), as shown on the picture above.

Friendly notice:

If the mounting positions cannot be aligned well which hinders the installation, then sway the Seat(B) lightly when locking the Bolts; this action can help prevent the Bolts from getting stuck and ensure smooth assembly.

Do not fully tighten the Bolts.

Step 3

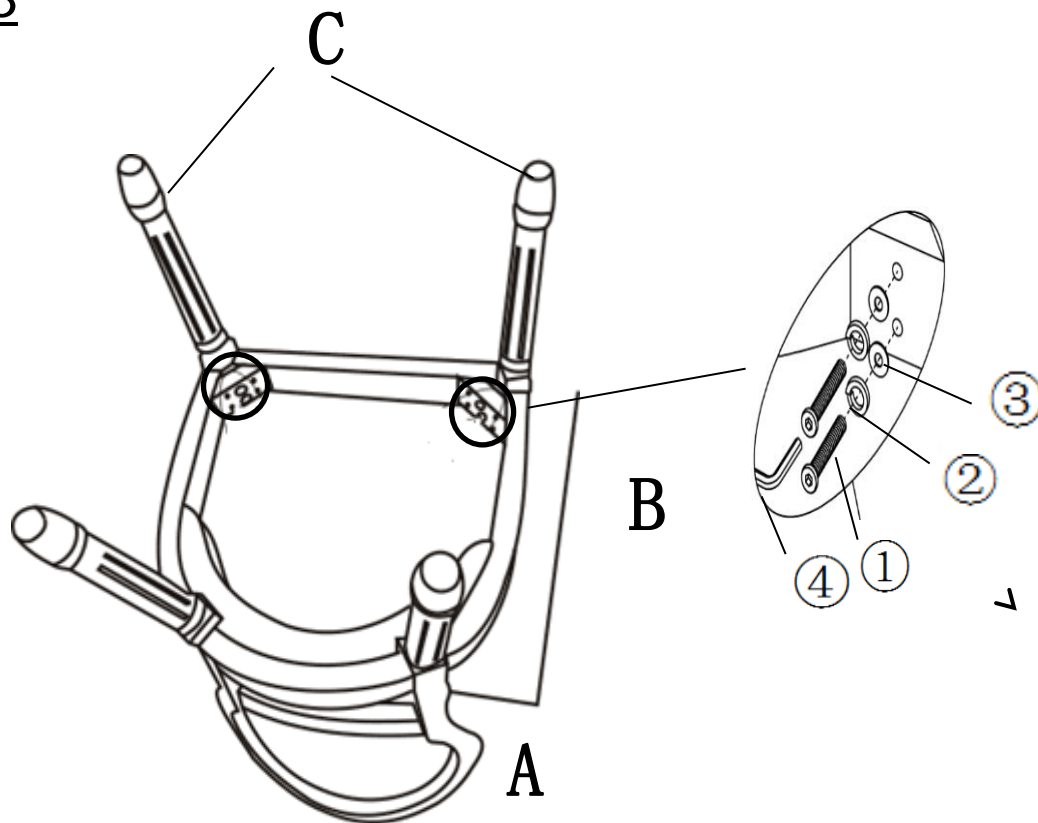

Place the Seat(B) and Back with Legs(A) on the edge of a table with the Seat(B) facedown, as shown in the picture.

Insert Front Leg(C) into the mounting position of Seat(B) and attach using Bolts(①), Spring Washers(②) and Washers(③) with Allen Key(④).

Do not fully tighten the Bolts.

Repeat the same process to attach the remaining Front Leg.

Step 4

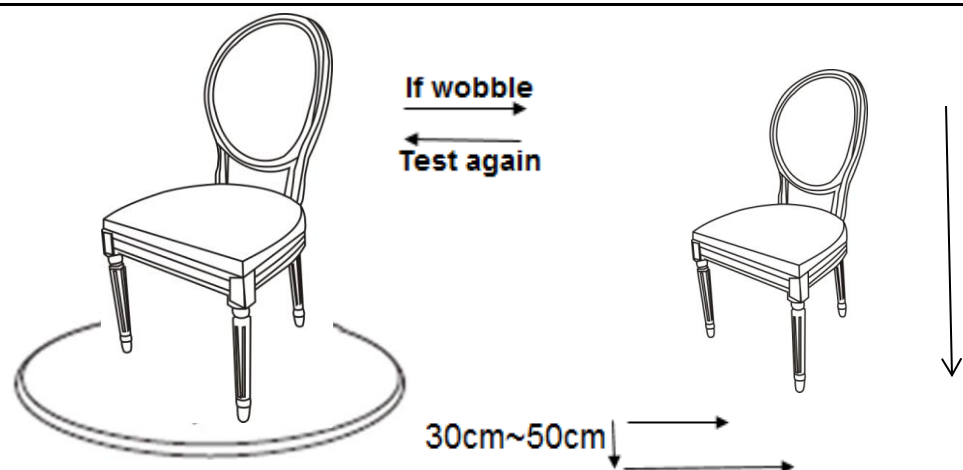

Place the Dining Chair on a LEVEL SURFACE to check for wobbles. If it wobbles, lift the Dining Chair some 30cm to 50cm high from the ground.

Keep your feet and toes well away from the drop zone.

Drop the Dining Chair freely and vertically with the four legs, hitting the ground, at the same time.

This Drop Test will help to ensure that all the Bolts and gaps reach full alignment status.

Test again for evenness on a LEVEL SURFACE.

If no wobbles are found, proceed to tighten all the Bolts.

When tightening the Bolts, tighten sequentially.

DO NOT tighten any Bolt fully and then towards the next one.

This could cause the frame to warp.

If there are still wobbles, loosen the Bolts and execute the same drop test.

If the Dining Chair is not stable, it could lead to damaging the product.

Step 5

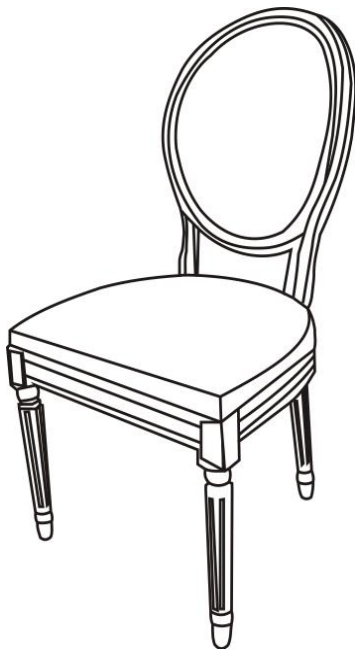





















Stand the Dining Chair up.

Your Dining Chair is ready for use.

This Dining Chair can only be used on a flat, level surface.

Care & Maintenance

-   ● Do not put hot items directly on furniture surface
 -   ● Do not clean furniture with harsh cleansers or polish.
 -   ● Do not place furniture under direct sunlight.
 -   ● Do not place furniture near heating or cooling vents.
 -   ● Do not write on furniture without a padded barrier to protect the surface.
 -   ● Do not place furniture outside . For indoor use only .
 -   ● Not for commercial use. For residential use only .
 -   ● Stains may be removed with mild soap solution and damp cloth.
 -   ● Children should not climb or jump on the furniture.
-
-   ● Dust and pick-up spills using a clean, non-colored, lint-free cloth .

Questions & Answers about Proposition 65

• What is Proposition 65?

Proposition 65 requires businesses to provide warnings to Californians about significant exposures to chemicals that cause cancer, birth defects or other reproductive harm. These chemicals can be in the products that Californians purchase, in their homes or workplaces, or that are released into the environment. By requiring that this information be provided, Proposition 65 enables Californians to make informed decisions about their exposures to these chemicals.

Proposition 65 also prohibits California businesses from knowingly discharging significant amounts of listed chemicals into sources of drinking water.

Proposition 65 requires California to publish a list of chemicals known to cause cancer, birth defects or other reproductive harm. This list, which must be updated at least once a year, has grown to include approximately 900 chemicals since it was first published in 1987.

• What types of chemicals are on the Proposition 65 list?

The list contains a wide range of naturally occurring and synthetic chemicals that include additives or ingredients in pesticides, common household products, food, drugs, dyes, or solvents. Listed chemicals may also be used in manufacturing and construction, or they may be byproducts of chemical processes, such as motor vehicle exhaust.

• What does a warning mean?

If a warning is placed on a product label or posted or distributed at a workplace, a business, or in rental housing, the business issuing the warning is aware or believes that it is exposing individuals to one or more listed chemicals.

By law, a warning must be given for listed chemicals unless the exposure is low enough to pose no significant risk of cancer or is significantly below levels observed to cause birth defects or other reproductive harm.

• Where can I get more information on Proposition 65?

If you have specific questions on the administration or implementation of Proposition 65, you can contact OEHHA's Proposition 65 program at P65.Questions@oehha.ca.gov, or by phone at (916) 445-6900.