

ASSEMBLY INSTRUCTIONS

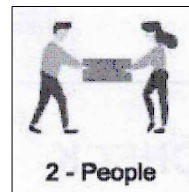
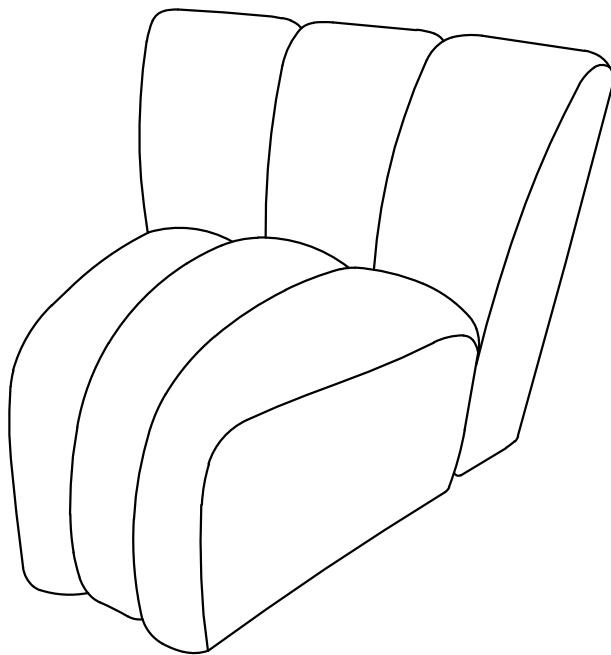

Enjoying this product? We'd love your 5-star review!

If you have any issues, our support team are happy to help.

Thank you for your purchase!

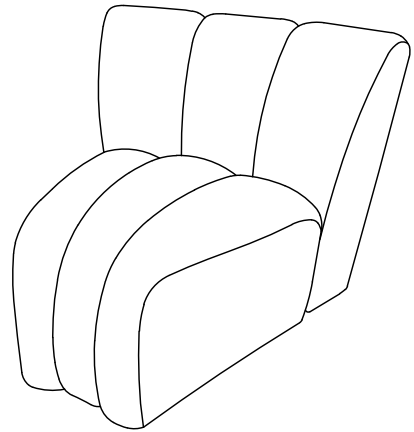

CHECK BEFORE STARTING

Are you missing anything?

Please double check all hardware and parts match the assembly guide before putting the product together. If damaged, we suggest you put the item back in the box and start your claim or return

Should we send any replacements?

If there are any manufacturer defects or missing pieces please contact us for replacements. If purchased online, please contact the website of where you purchased it from, DIRECTLY

IMPORTANT INFO before assembly:

- If there's a problem with the parts do not attempt to assemble the product
- Place all parts on a clean and smooth surface such as a rug/carpet to avoid parts from being scratched
- When tightening screws to product do not overtighten until product is fully setup
- If product is too heavy for a single person to carry do not attempt and ask for assistance
- DO NOT DRAG or PUSH item to desired location. Must be carried when moving
- If item is not working as intended please review the assembly guide to see if any steps were missed or incorrectly built. If there's a problem with part please contact seller for additional assistance
- Please keep all hardware and small parts away from pets/infants
- Please wear gloves or protective gear to protect from getting cuts
- It is normal for new furniture to have an off gassing smell. Please air out furniture near a window for a few hours or a day before placing it in its desired location
- All products may have a slight color and texture variation due to different shipments, natural materials, screen-resolutions, or lighting in home. Images are rendered by different devices or websites

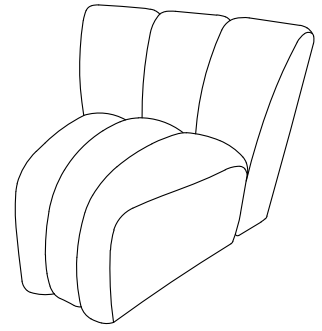

Please keep instructions for future reference

Check the quantity and irregularity of parts and hardware before you start

If assembly guide is misplaced, please visit our website for a copy

Arc Curved Corner Chair

Part List

#1 1pc

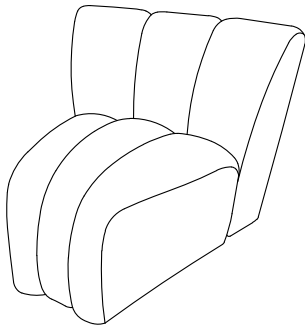

Arc Curved Corner Chair

Hard ware List

#A 4pcs

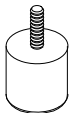

Support leg

If any parts/hardware listed are damaged or missing
Please contact the seller for additional assistance

ASSEMBLY INSTRUCTIONS

IMPORTANT

**Please keep Hex Wrench in a safe place as you may need to tighten up the Bolts in the future*

**Use a soft cloth between these parts and floor.*

Step 1

Attach the Support leg(#A) to Seat frame(#1).

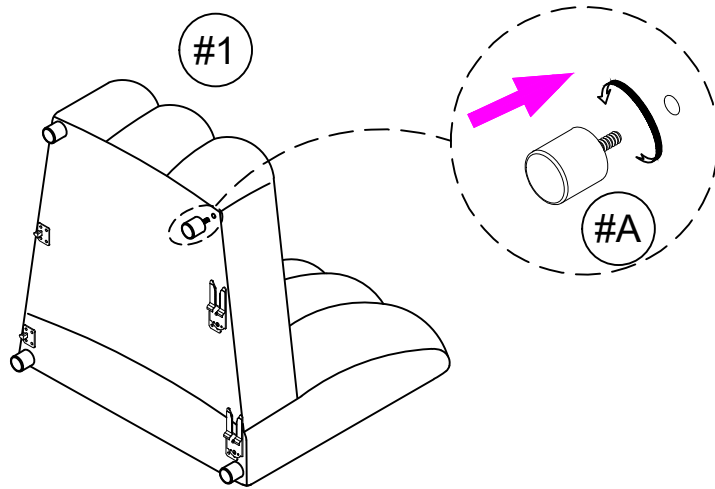

Step 2

Open the connection function to the outside as shown.

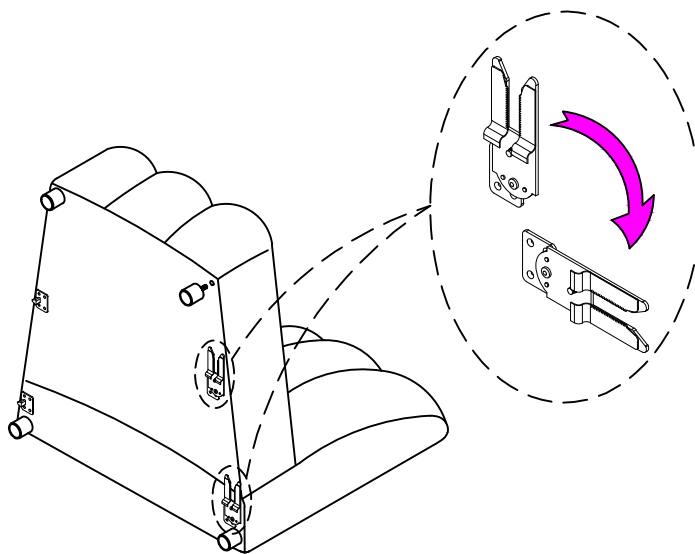

ASSEMBLY INSTRUCTIONS

IMPORTANT

**Please keep Hex Wrench in a safe place as you may need to tighten up the Bolts in the future*

**Use a soft cloth between these parts and floor.*

Step 3

Connect

