

USE AND MAINTENANCE

The interior is constructed of mirrored glass and aluminum.

Use only a damp cloth to clean. Ammonia or vinegar-based cleansers can damage mirrors.

When cleaning, spray the cloth, not the mirror, or surrounding surfaces.

Do not use abrasive cleansers on any part of the light fixture.

EXTENDED WARRANTY SERVICE

Please send your Purchasing Order No. to register extended 2 years

warranty on hardware components. We pride ourselves with a 100% Customer Satisfaction Guarantee.

We are confident in our products and stand behind them 100%. Just reach to us with any questions or concerns and we will be happy to help in less than 24 hours!

*****IMPORTANT NOTICE*****

We will guarantee all customer benefit. The products we ship out are brand new. Please check carefully before installation, compare all parts with the parts listed in the package contents section. If any part appears missing or damaged, do not install.

Send us the pictures or video, we promise will response to you with 24 hours. We will decide send you spare parts or deliver a replacement by free.

IMPORTANT SAFETY INSTRUCTIONS

When using an electrical furnishing, basic precautions should always be followed, including the following:

⚠ WARNING: To reduce the risk of burns, fire, electric shock or injury to persons. Use this furnishing only for its intended use as described in these instructions. Do not use attachments not recommended by the manufacturer. Never drop or insert any object into any opening. Do not use outdoors.

⚠ WARNING: Risk of electric shock. Connect this furnishing to a properly grounded circuit only. See grounding instructions.

⚠ CAUTION: Maximum shelf load 34lbs/15.4kg

ELECTRIC CONNECTIONS

ALL WIRING SHOULD BE DONE BY A QUALIFIED LICENCED ELECTRICIAN.

⚠ WARNING: Shut off power before wiring the cabinet.

Requires 120 VAC 20 Amp GFI protected Circuit.

GROUNDING INSTRUCTIONS:

⚠ CAUTION: This product must be connected to a grounded metal permanent wiring system or an equipment-grounding conductor must be run with the circuit conductors and connected to the equipment grounding terminal or lead on the product.

⚠ WARNING: An Electrical option cabinet must be wired to a 20 Amp GFI (Ground Fault Interrupter) protected circuit when used in bathrooms and all other locations required by the National Electric Code.

The electric wire comes through the access hole on the top of the cabinet, exact location of access hole varies depending on the product models. Please refer to the actual product for the exact location.

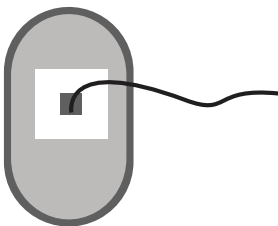

Make connection with Junction box

Neutral to white.
Line to black.
Ground to green.

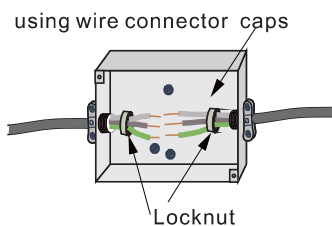

★ junction box is not included ★

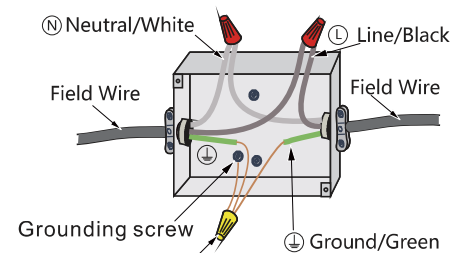

wire connector caps
★ (not included) ★

HARDWARE AND TOOLS

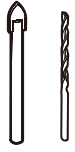

1/4" & 1/8" Drill Bits



Pencil



Level

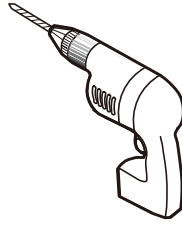

Power Drill



Mallet



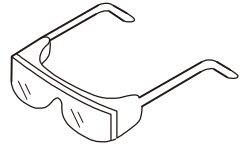

Tape Measure



Safety Goggles

HARDWARE LIST

ITEM	REFERENCE IMAGE	NAME	QTY
1		Screw ST4*35	2
2		Wall Anchor	2

Step 1

Level and mark the mirror's location on the wall.
Connect the wire to Junction Box inside the wall.

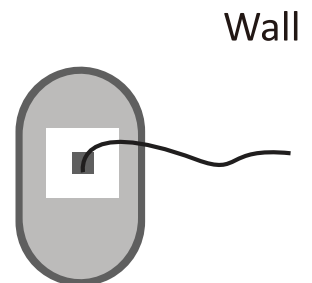
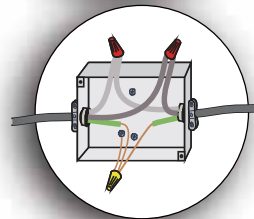
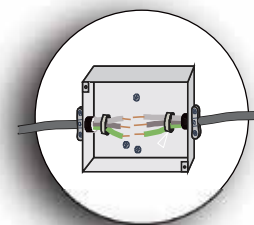
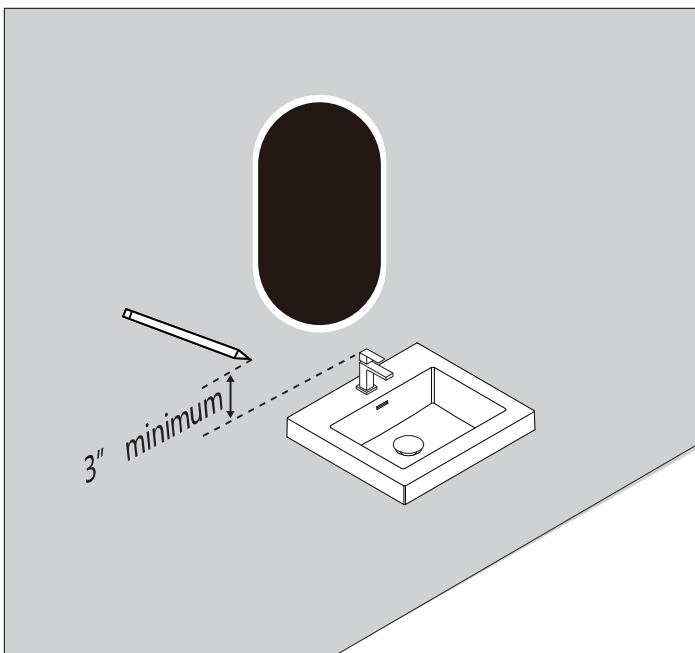

Step 2

Use the tape measure the height, and draw the horizontal line and the vertical line of the wash-basin. Measure the distance of the mirror hole, and mark the hole place on the wall.

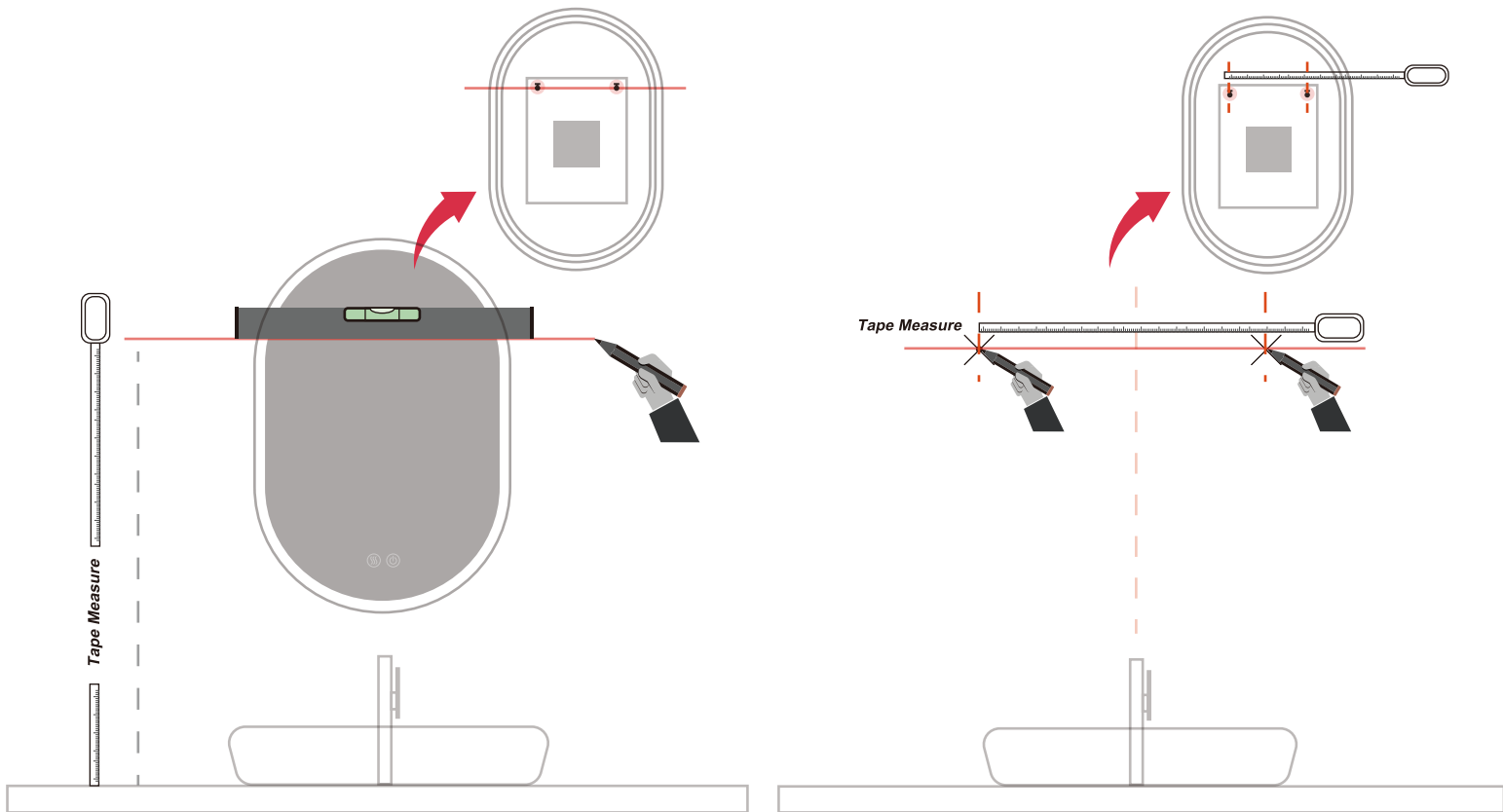

Step 3

Drill and insert the Wall Anchor, Drive in the screw cross the bottom support.

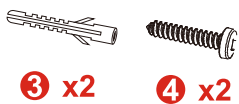

3 x2

4 x2

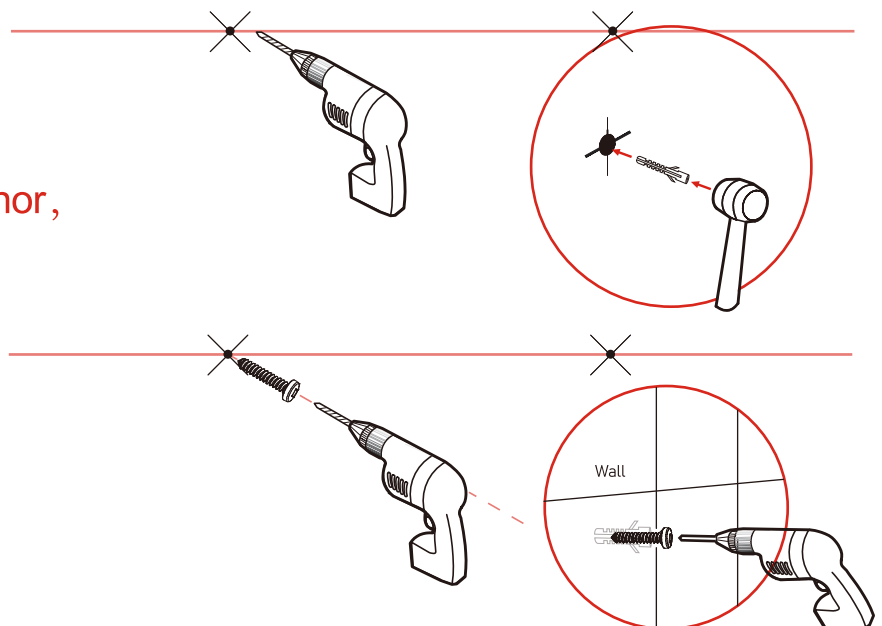

Step 4

Align the holes of the mirror with the screws and hang them to complete the installation

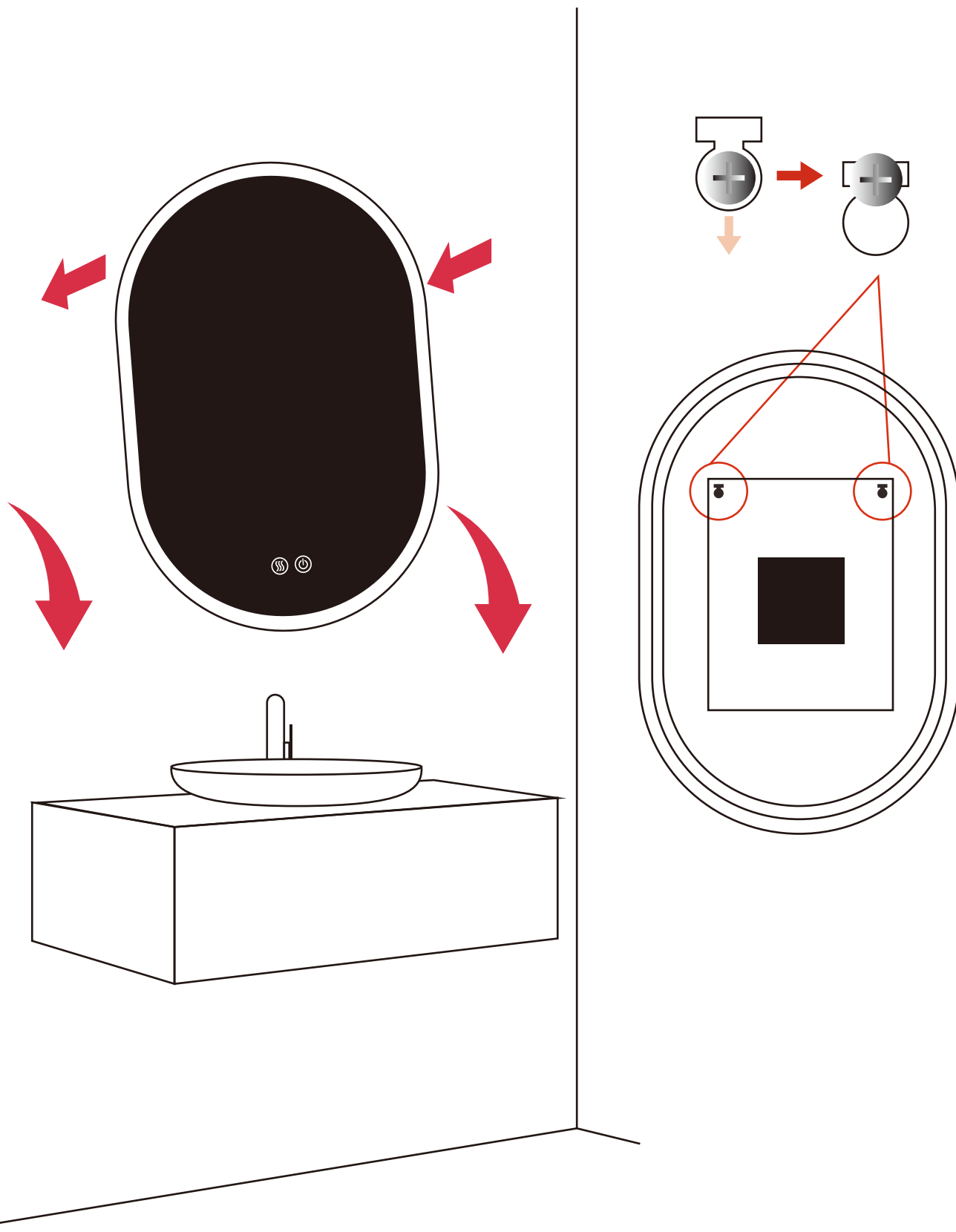

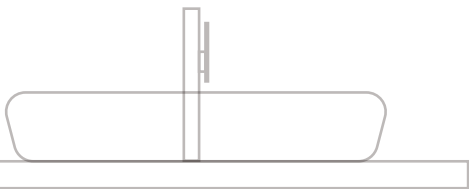
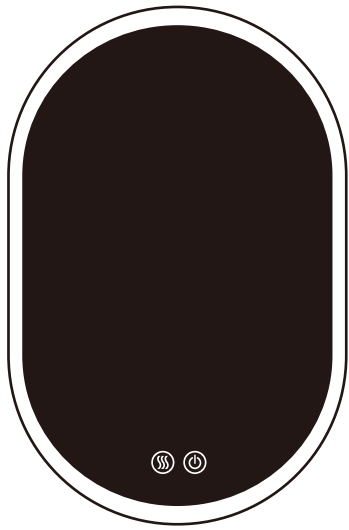

After power on, the button shows blue and it is in waiting state



Click the button to make the light gradually dims

Click the button again and the light gradually brightens



After power on, the button shows blue and it is in waiting state,
lick to turn on the defogging function and the button turn to white.
Click again to turn off the defogging function and the button turn to blue.

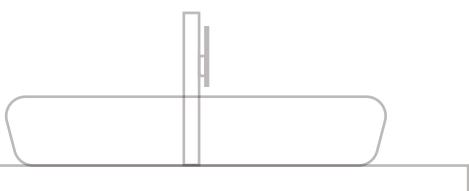
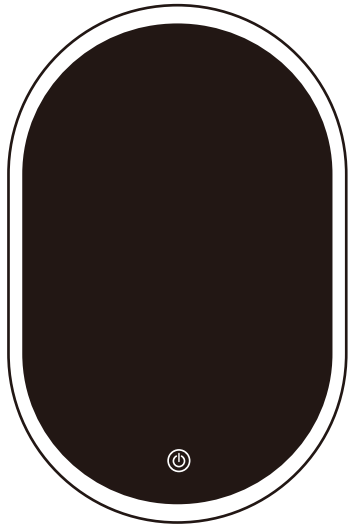

After power on, the button shows blue and it is in waiting state



Click the button to make the light gradually dims

Click the button again and the light gradually brightens