

END TABLE

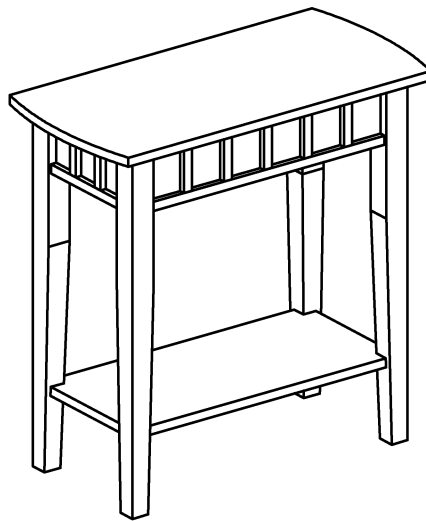





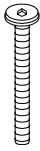

Assembly Instruction

We have designed our furniture with you, the customer in mind. Our clear, easy to follow step by step instructions will guide you through the project from start to finish. Feel confident that this will be a fun and rewarding project. The final product will be a quality piece of furniture that will go together smoothly and give years of enjoyment.

Please verify all parts are present before beginning assembly

Hardware List

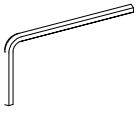
A 	B 	C 	D 
Allen Bolt (8 pcs)	Spring Washer (8 pcs)	Flat Washer (8 pcs)	L Bracket (4 pcs)
E 	F 	G 	
Small Screw (8 pcs)	Wooden Dowel (4 pcs)	Allen wrench (1 pc)	

Parts List

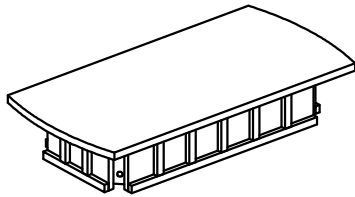

(1) - Table Top (1pc)

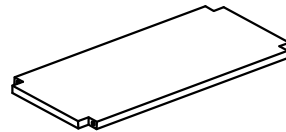

(2) - Shelf (1pc)

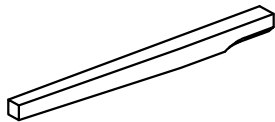

(3) - Left Leg (2pcs)

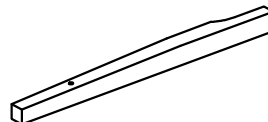

(4) - Right Leg (2pcs)

Assemble unit on carpet or other soft surface

Step 1

1. Insert Wooden Dowel (F) to Shelf (2) as shown.

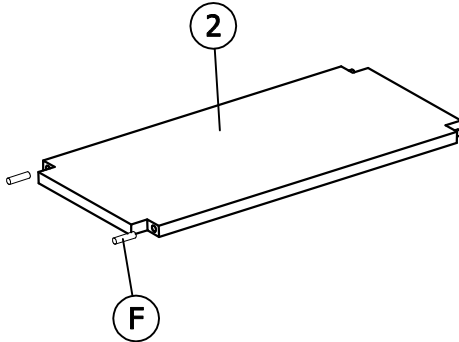

Step 2

1. Connect Left Legs (3) and Right Legs (4) to Table Top (1) and Shelf (2) using Allen bolt (A), Spring Washer (B), Flat Washer (C) and Allen Wrench (G) as shown.

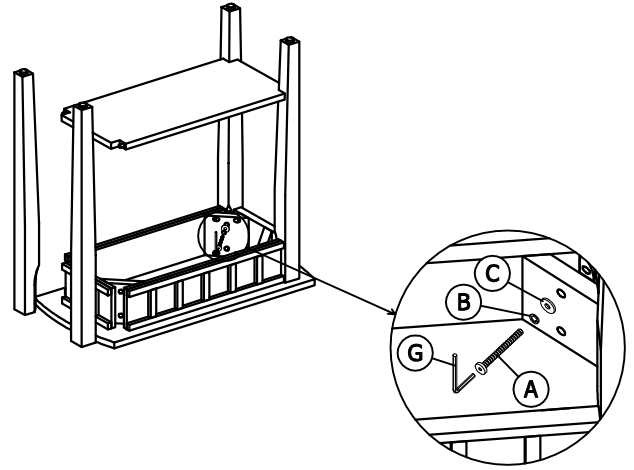

Step 3

1. Connect Shelf (2) to Left Legs (3) and Right Legs (4) using L Brackets (D) and Small screws (E) as shown

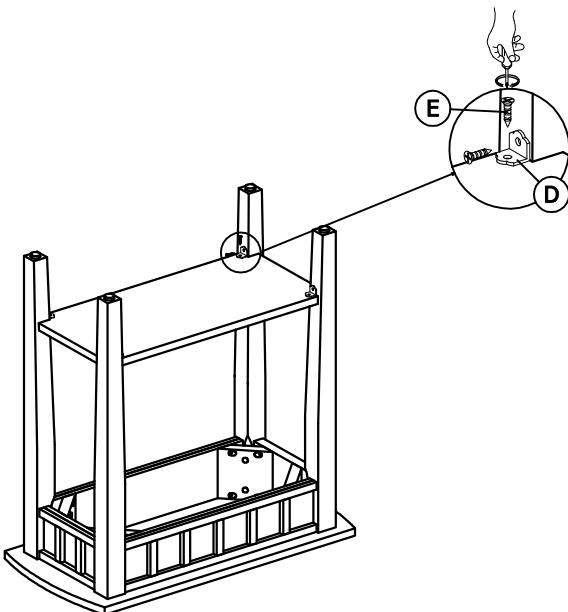

Step 4

1. Enjoy

