

Panda

Instruction Manual

Spin Dryer

Model: PANSP23B

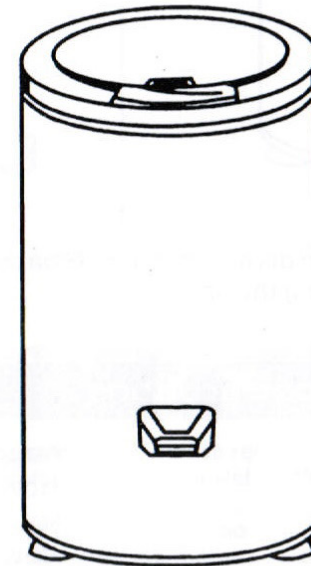

Panda Products
Toll Free: 1-866-371-2888
email: service@ezbyonline.com
www.ezbyonline.com

FOR ANY TECHNICAL SUPPORT, PLEASE CONTACT OUR TOLL FREE CUSTOMER SERVICE HOTLINE OR EMAIL US

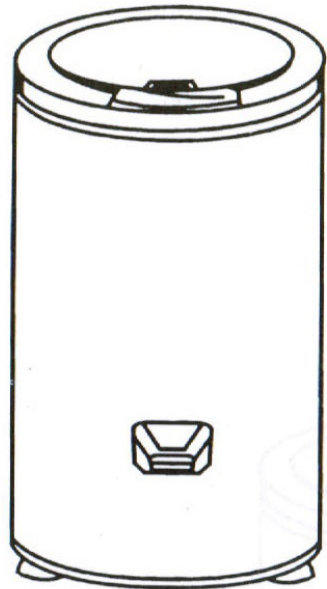

Instruction Manual Spin Dryer

Thanks for your spin dryer purchase. Please read the manual carefully before using the spin dryer.

Technical Specifications

Model:	PANSP23B
Rated Voltage:	110V-120V
Frequency:	60Hz
Power:	300W
Capacity:	16-22 lbs
Speed	3200 rpm
Weight:	26.4 lbs
Height:	26 inches

Main Parts

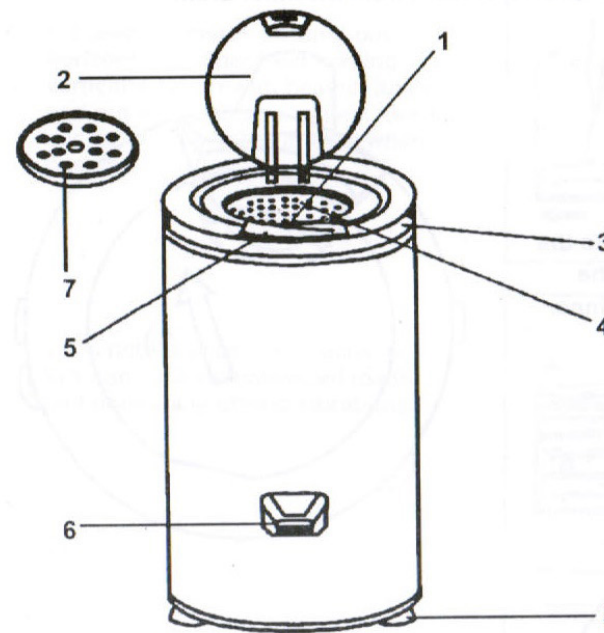

1. Safety Lock
2. Lid
3. Handle
4. Inner Drum
5. Operating Lever
6. Drain Spout
7. Protector Disk
8. Foot

Setting Up Your Spin Dryer

1. For first time use Panda spin dryer, please remove the protector foam from the inner drum, then clean the drum with wet cloth.
2. Remove the motor locking parts from the bottom of the unit. This motor locking part is only for protection the motor purpose during shipping.
3. Check to make sure your electric supply is 110V/60Hz and properly grounded.
4. This spin dryer **MUST** be placed on a level floor
5. Place a container under the drain spout.

Remove the Motor Locking System Before Use

Remove the protector foam from the inner drum

1) Turn the operating lever to the position "OFF", remove the protector foam from the inner drum.

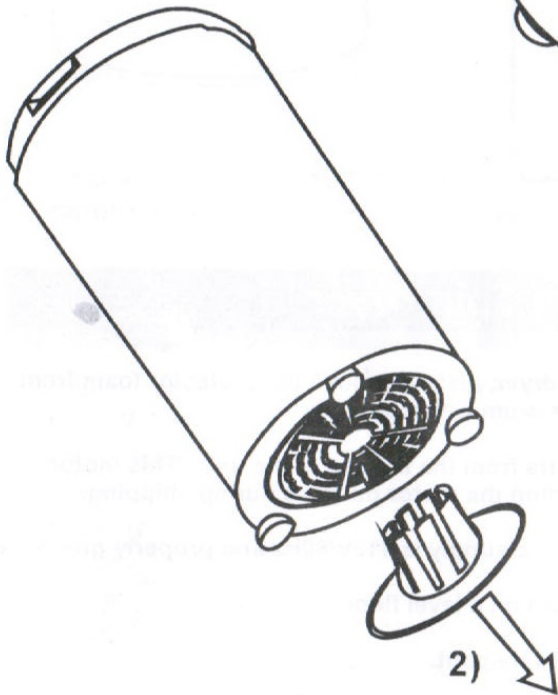
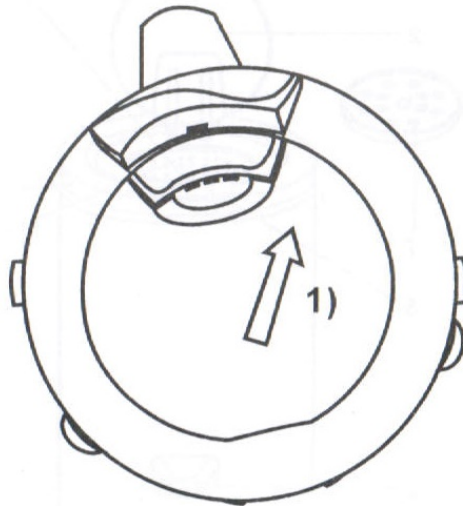

2) Remove the motor locking system from the bottom of the machine.

How to Properly Load the Spin Dryer

1. Spread items of clothing out horizontally rather than loading vertically. Begin with heavier items and put the lightest, smallest items such as socks in the middle when possible.

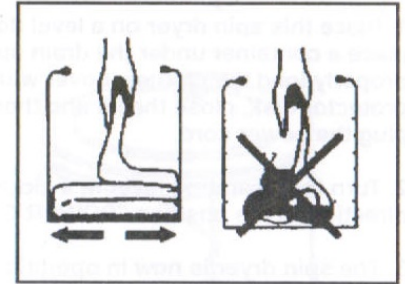

2. Do not leave empty spaces as this can cause unbalanced loads and potentially strong vibrations.

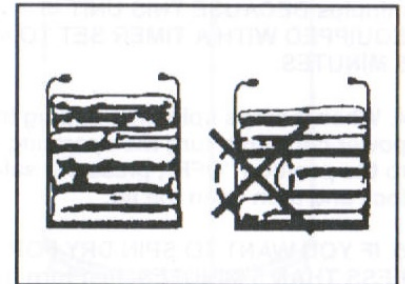

3. When possible fill completely. It is fine to use the machine if not completely full, but if you have enough laundry for a full load it's best to run a full one.

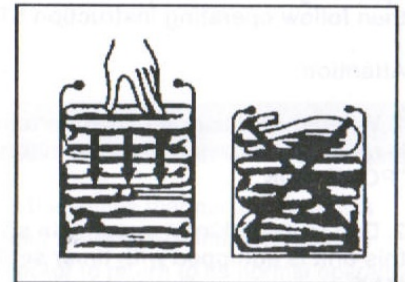

4. Put the protector disk over the clothes and under the edges of the inner tub. **IMPORTANT:** For your safety, remember to never put any type of footwear in the spin dryer.

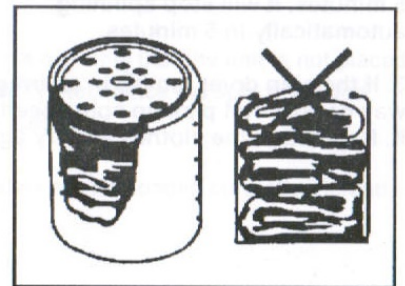

Operating Instructions

1. Place this spin dryer on a level floor, place a container under the drain spout, properly load the clothes, cover with protector disk, close the lid and then plug the power cord.

2. Turn the operating lever in a clockwise direction to the position "POWER ON"

3. The spin dryer is now in operation, it will stop spinning automatically in 5 minutes **BECAUSE THIS UNIT IS EQUIPPED WITH A TIMER SET TO MAX 5 MINUTES.**

4. When it stops spinning, unplug the power cord first, turn the operating lever to the position "OFF", press the safety lock and then open the lid.

5. IF YOU WANT TO SPIN DRY FOR LESS THAN 5 MINUTES, just turn the operating lever to the position "OFF", then follow operating instruction STEP 4.

Attention:

1. When the lid is open, the operating lever can't be turned to the position "POWER ON"

2. Due to its 3200rpm super spin speed, this unit is equipped with timer set to **MAX** 5 minutes, it will stop spinning automatically in 5 minutes.

3. If the spin dryer moves in an irregular way or does not pick up spin speed, stop it. Reposition the clothes and try again.

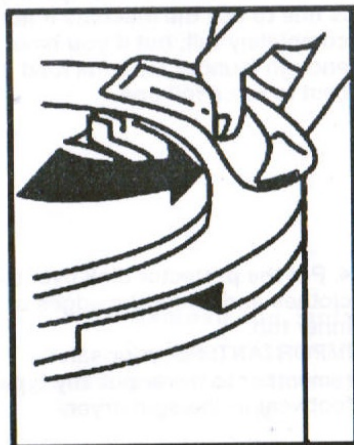
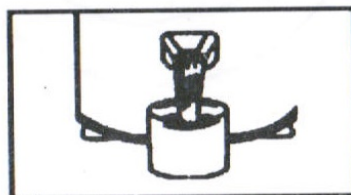

Maintenance and Care

1. Always unplug the spin dryer before cleaning.

2. After each use, tilt the machine in the direction of the drain spout to remove any remaining water.

3. Do not use abrasive cleaning agents which can damage the unit.

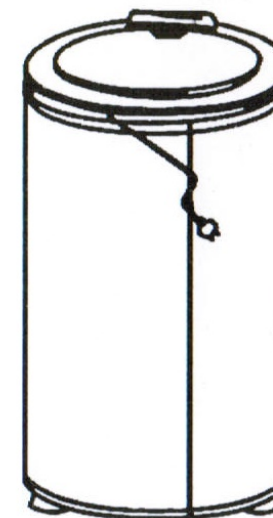

Troubleshooting Guide

If the motor does not function, it's possible that the engine thermal protector has temporarily shut it off. In this case, it's better wait between 5-20 minutes then try again. This period of time is necessary for the motor to return to its normal operating temperature.

If the spin dryer does not pick up spin speed, it's possible that the unit is not placed on a level floor or clothes are not loaded correctly. Rebalance the spin dryer and reload the clothes follow correct loading instructions.

If the spin dryer "walks", it's possible that clothes are not loaded correctly. Reload items follow correct loading instructions.



Spin Dryer

Loading Instructions

INCORRECT



Spread items of clothing out horizontally rather than loading vertically. Begin with heavier items and put the lightest, smallest items such as socks in the middle when possible.

CORRECT



INCORRECT

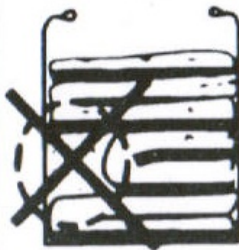

Do not leave empty spaces as this can cause unbalanced loads and potentially strong vibrations.

CORRECT



INCORRECT



When possible fill completely. It is fine to use the machine if not completely full, but if you have enough laundry for a full load it's best to run a full one.

CORRECT



INCORRECT



Put the protector disk over the clothes and under the edges of the inner tub.

IMPORTANT: For your safety, remember to never put any type of footwear in the spin dryer.

CORRECT



Caution: Remove motor locking parts before first time use.

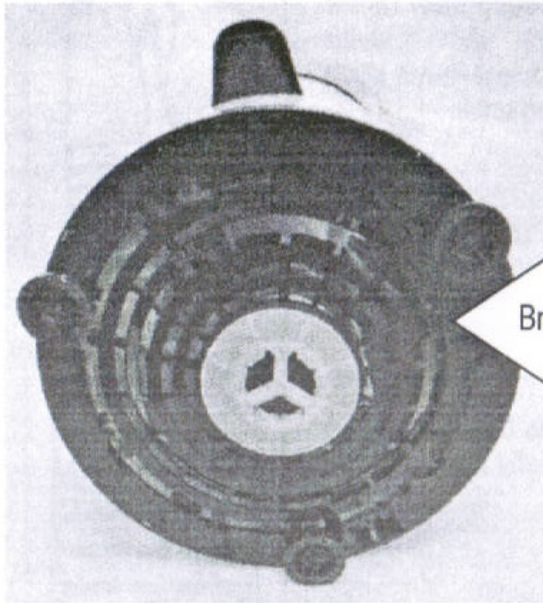

Brand new Panda spin dryer with motor locking parts.

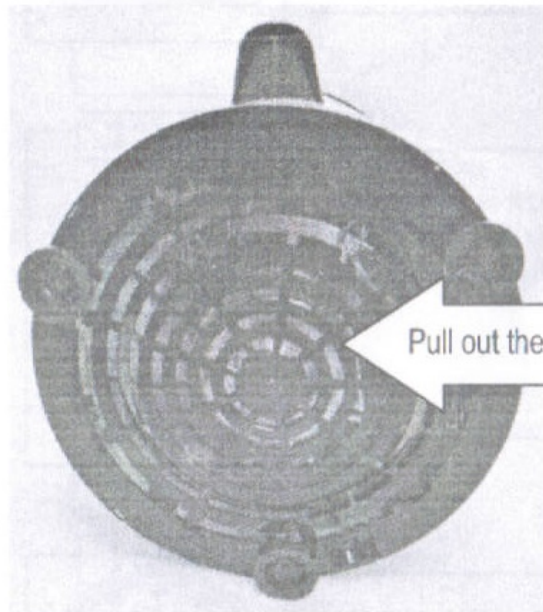

Pull out the motor locking parts, then the spin dryer is ready for use.

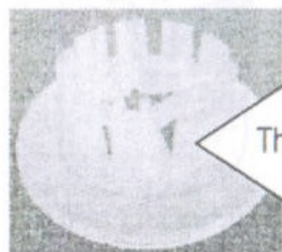

The motor locking parts are only for motor protection purpose during shipping.