

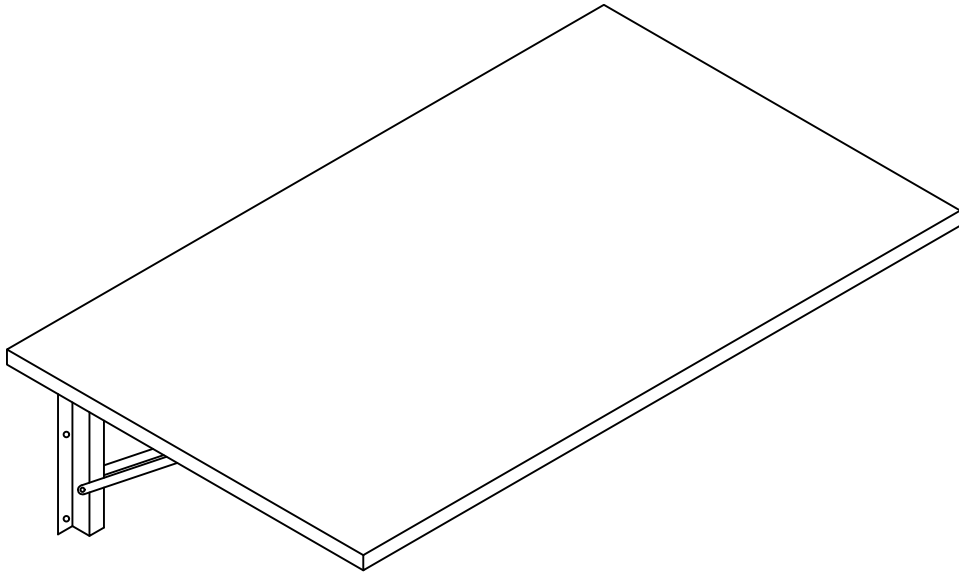

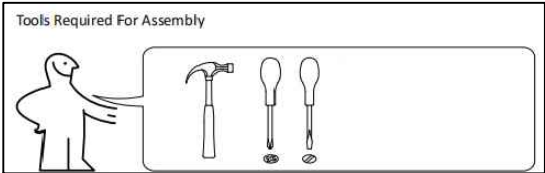

Instruction Manual

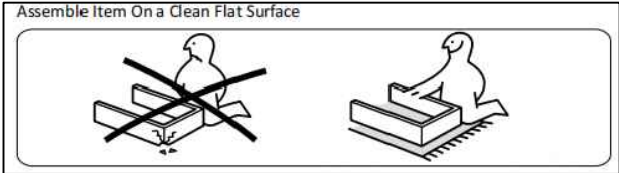

DEAR CUSTOMER,
 Thank you for choosing our product. Please read this manual carefully before assembling. If the product is passed on to the third party, this manual has to be passed on along with the product. Enjoy your new purchase!



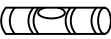

HARDWARE LIST

1	 ×12pcs	2	 ×12pcs	3	 ×6pcs	4	 ×1pc	5	
---	---	---	---	---	--	---	--	---	--

PARTS LIST

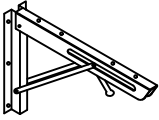
Note: there will be some error in the measurement, the actual size shall prevail.

A  ×2pcs	B  ×1pc		
--	---	--	--

NOTE

- Please check that you have all the parts and hardware listed before assembling.
- Please do not tighten all bolts until the table is assembled completely.
- If you find that something is missing, please contact the store you purchase immediately.
- At least every 4 months, check all bolts, screws and knobs to be sure they are tight.

Step:1

3

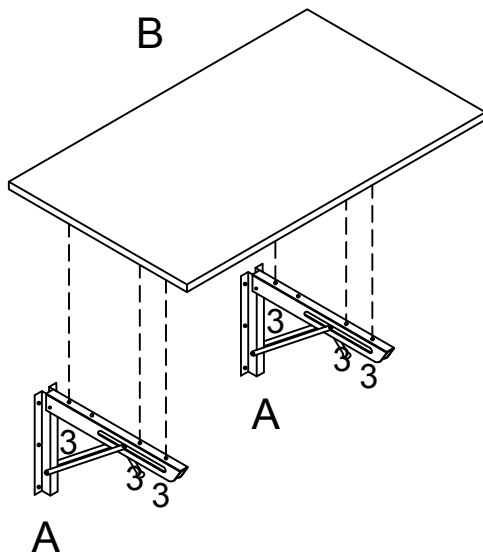
 ×6pcs



Install square tube and panel through fitting 3.

Step:2

1

 ×12pcs

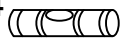
2

 ×12pcs

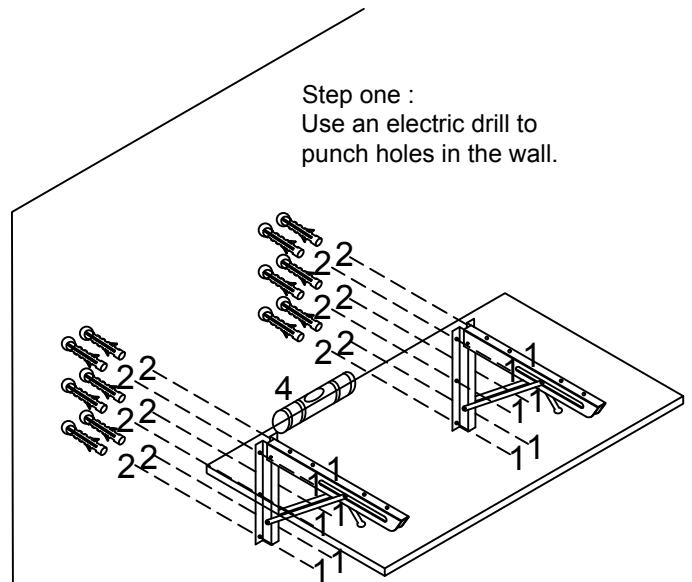
4

 ×1pc

Installation Complete !



Step one :
Use an electric drill to punch holes in the wall.

Step two:
Insert plastic expansion accessories.

Note : Flush with the wall.

Step three:
Screw the screw to the expansion piece.