

Computer Desk

Instruction Manual

D-L02-49IN

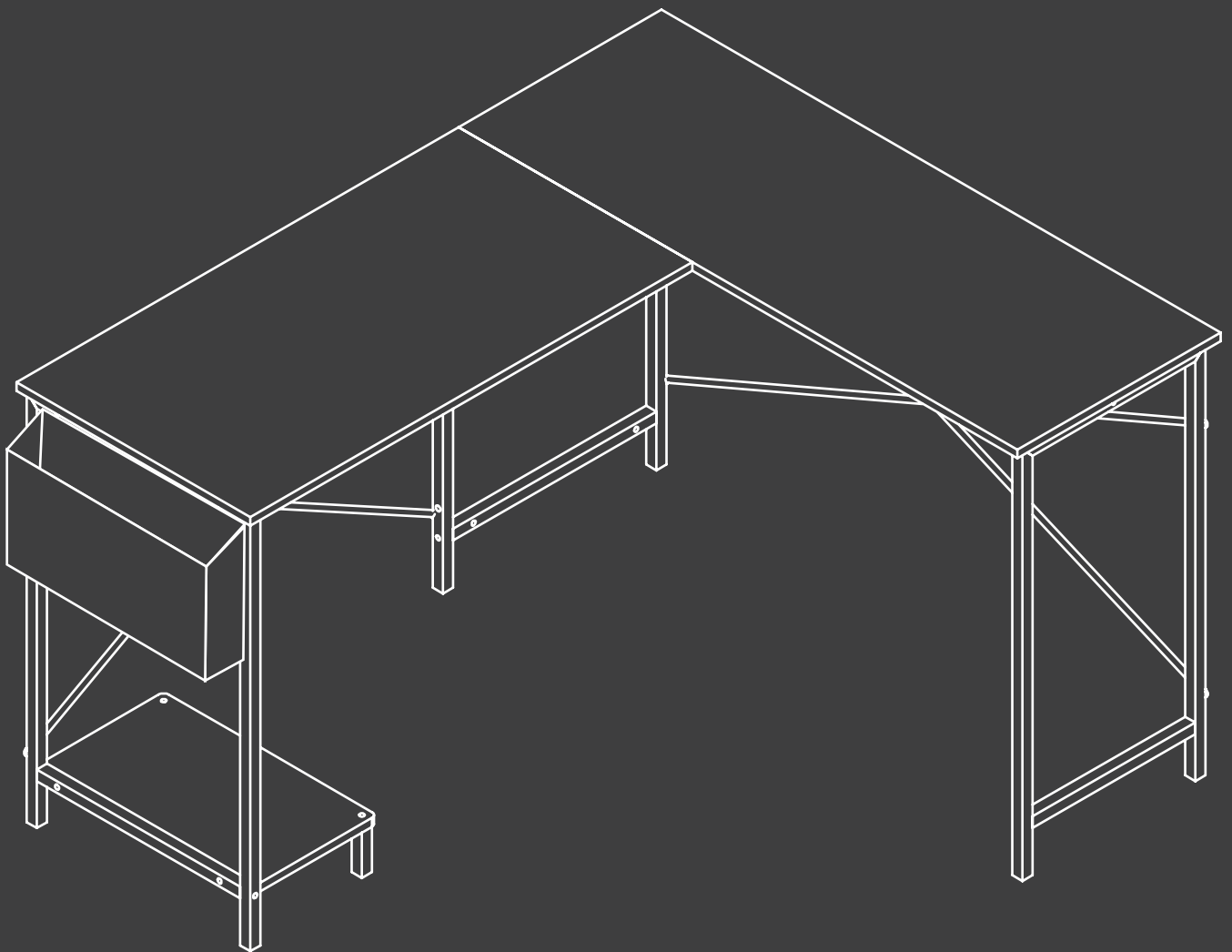

✉ HJ-Customer-Service@outlook.com

☎ (909)637-7665 | (909)637-7593

EST 9:00AM--17:00PM

1 Components List

A X1

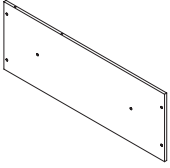

Board

B X1

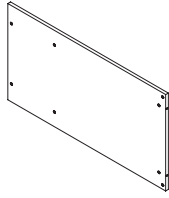

Board

C X1

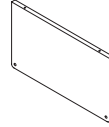

Stand

D X1

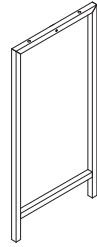

Leg

E X1



Leg

F X1

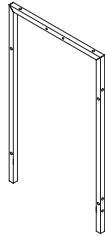

Leg

G X2

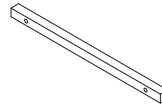

Crossbar

H X1

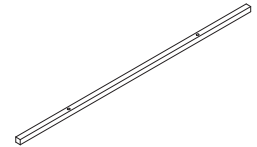

Crossbar

I X1

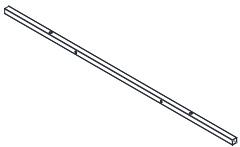

Crossbar

J X2

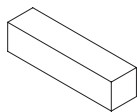

Foot

K X1



X-brace

L X1

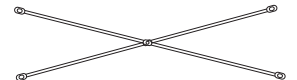

X-brace

M X1

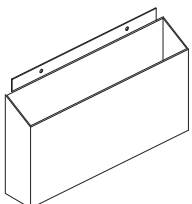

Felt Bag

2 Supplied Parts and Hardware

1 X21



Screws
M6*30mm

2 X8



Screws
M6*12mm

3 X1



Nut
M6

4 X2



Wooden Pins
8*40mm

5 X2



Screws
M6*50mm

6 X1



Allen Key
M4

7 X2



Cover-up Stickers
M6*12mm

8 X1

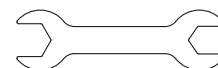



Wrench
M6-8

Important Note:

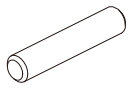

1. Do not wipe the desktop with corrosive liquids.
2. Keep the parts properly and out of reach of children to prevent swallowing.
3. Do not place overheated cookware or tableware on the desk to avoid damage.
4. You can choose another installation method and customize the position of the storage components according to your preference.

Step 1

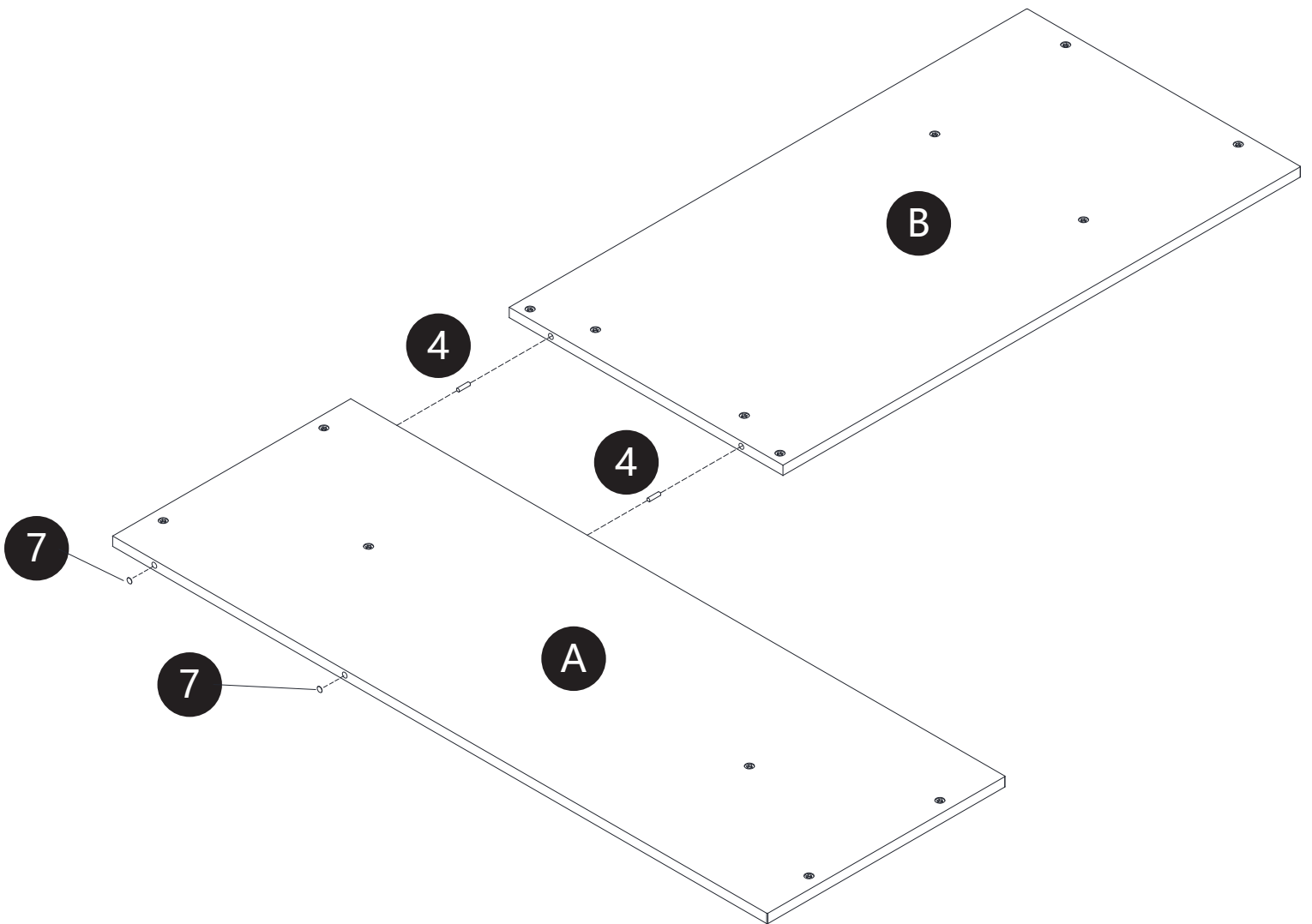
	
4 2pcs	7 2pcs





Step 2

	
1 4pcs	6 1pc

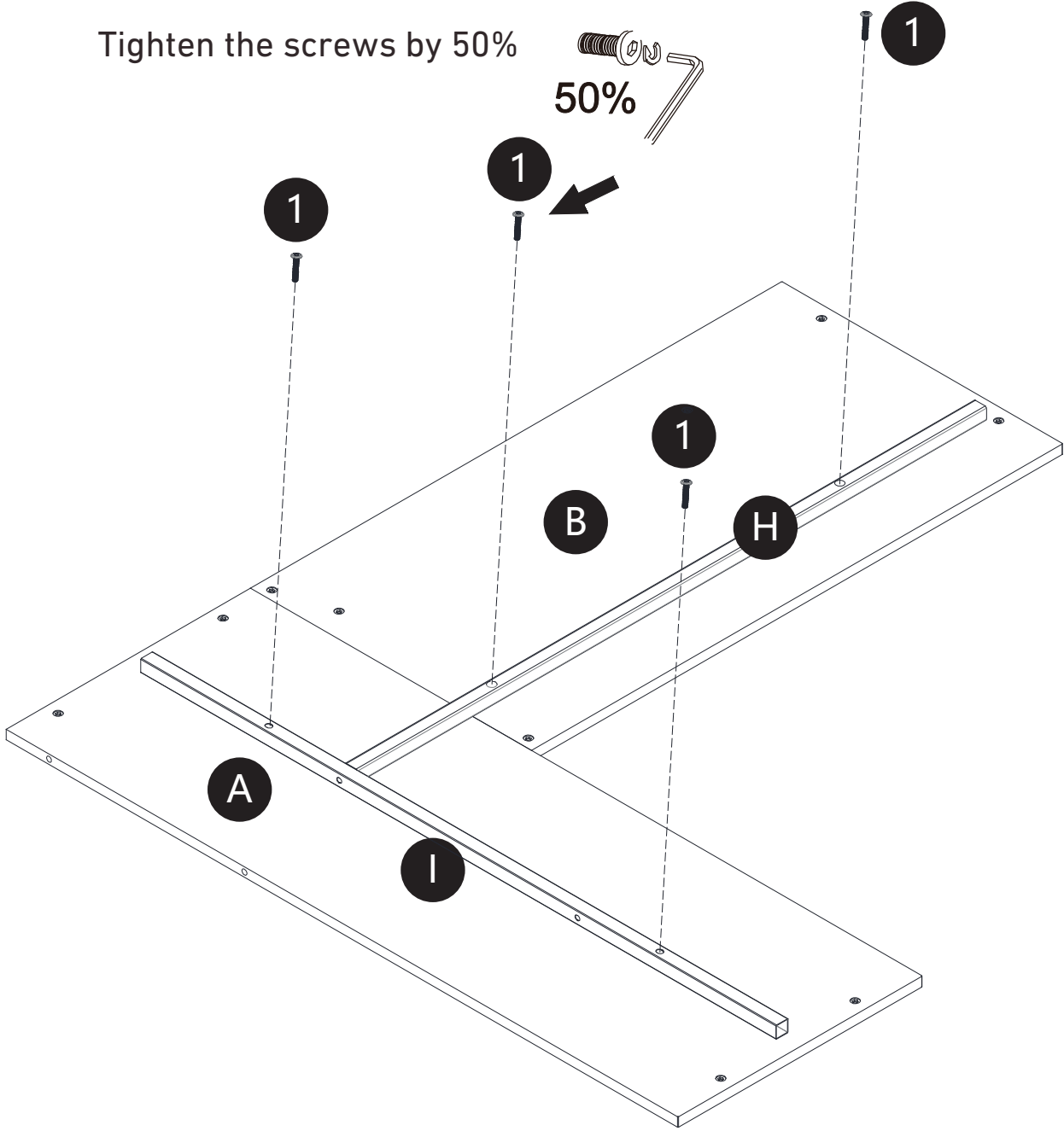
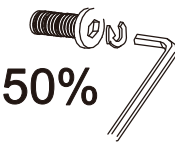
Tighten the screws by 50%



Step 3

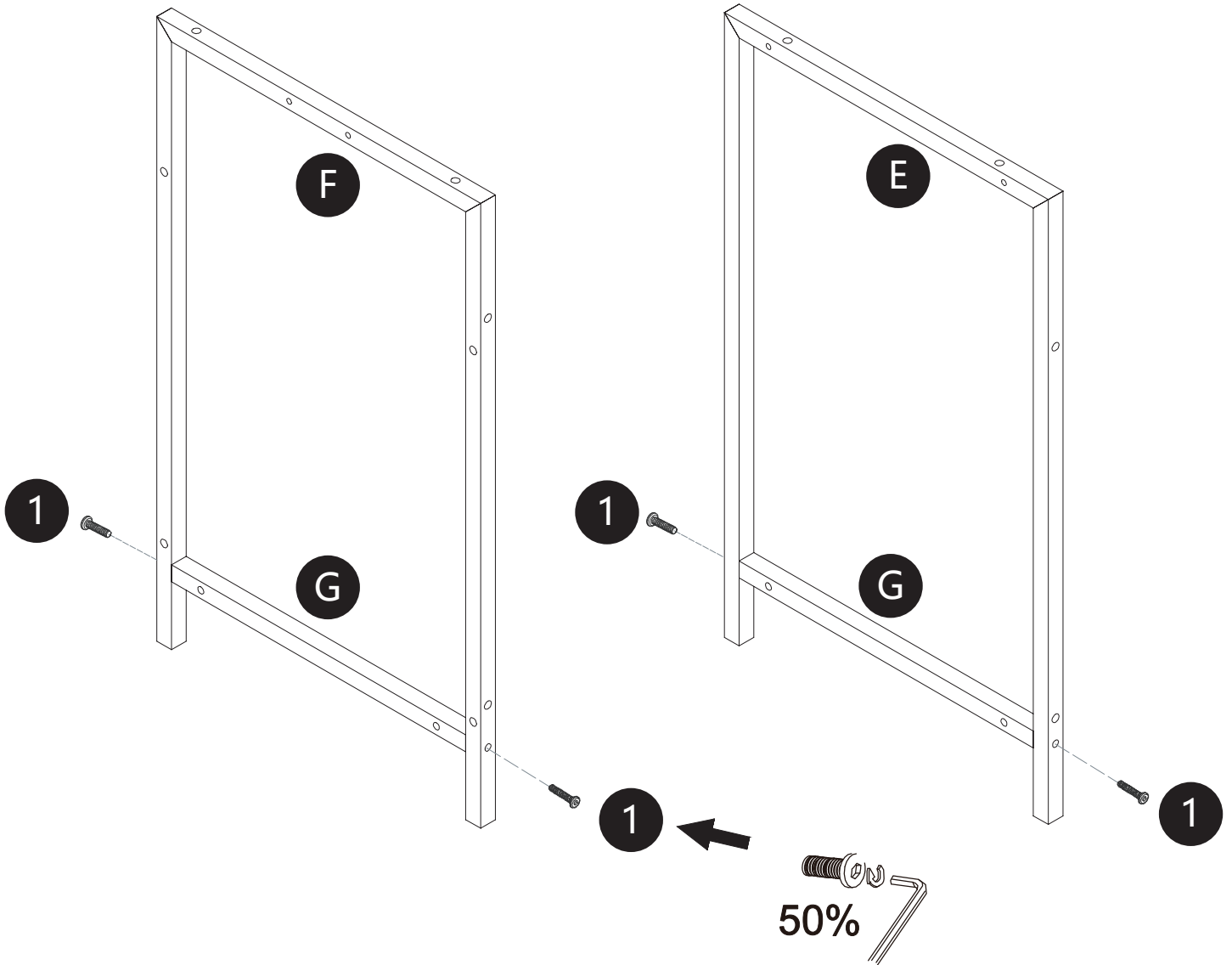

	
1 4pcs	6 1pc



Tighten the screws by 50%

NOTE: Pay attention to the orientation of the holes on Crossbar **G**.

Step 4

	
1 9pcs	6 1pc

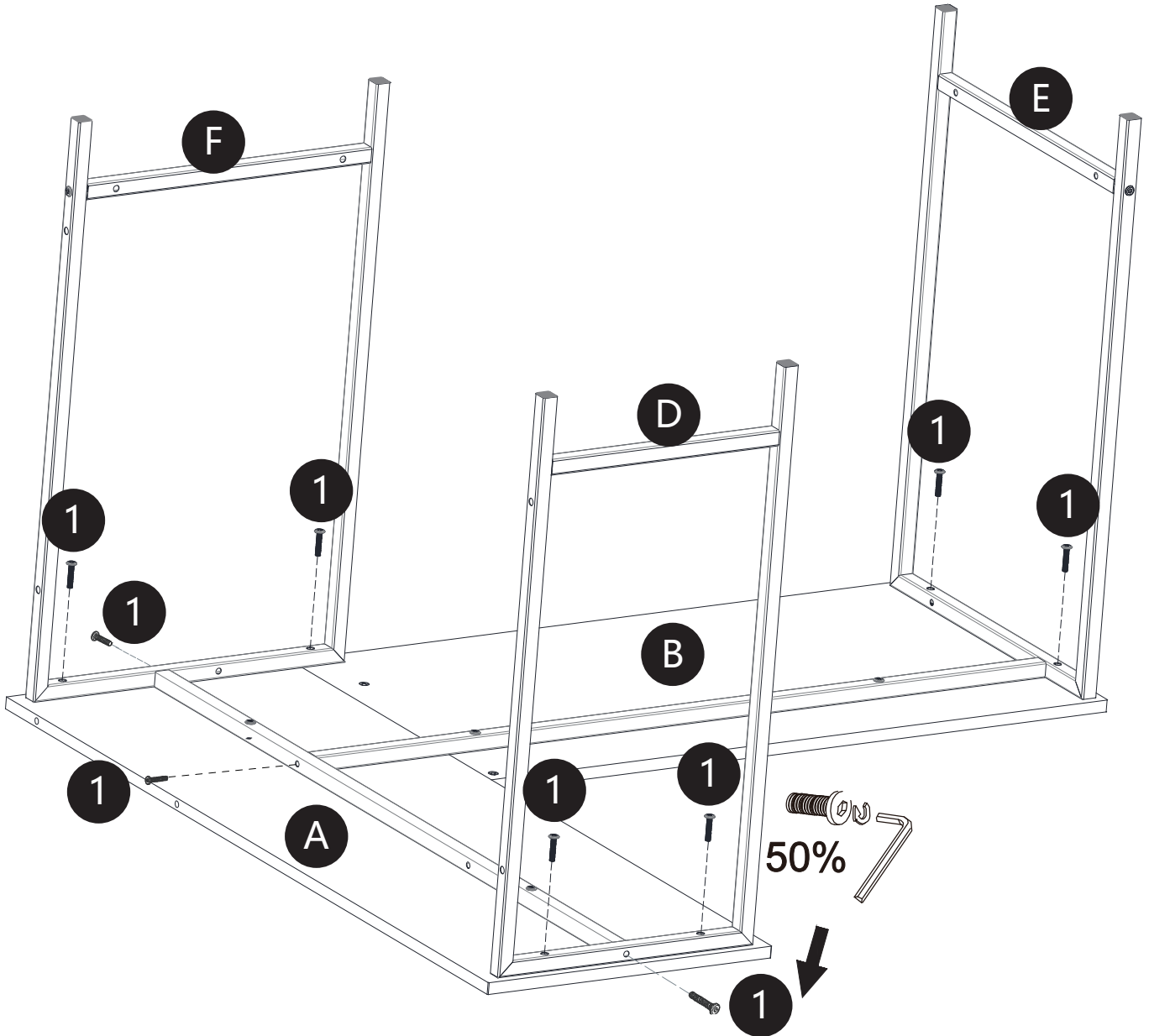



Tighten the screws by 50%

NOTE:

Pay attention to the orientation of the holes on components **E**, **F**, and **D**.



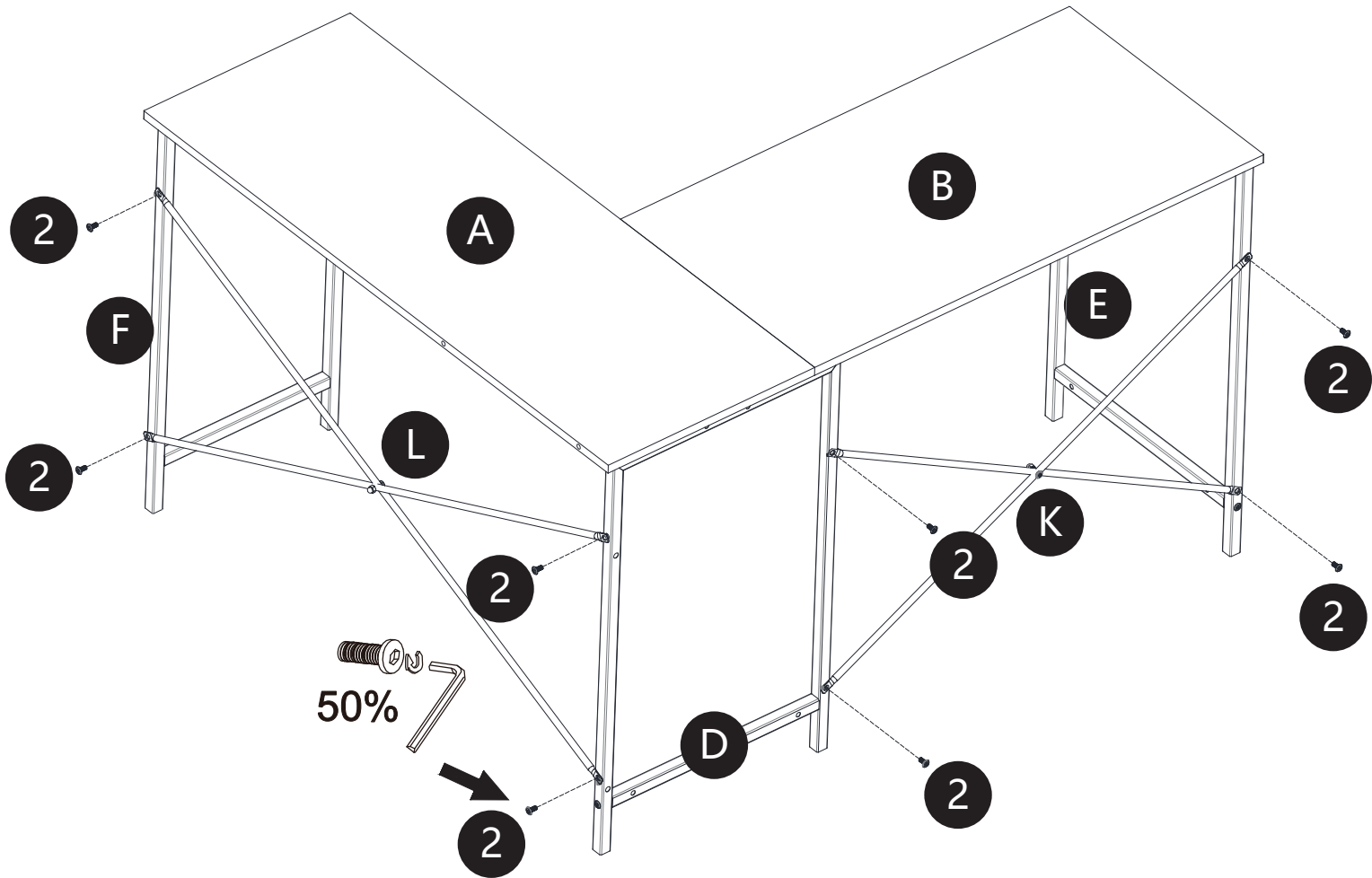

Step 5

	
2 8pcs	6 1pc

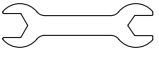

Tighten the screws by 50%

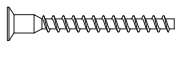
Step 6

				
8 1pc	1 4pcs	3 1pc	5 2pcs	6 1pc

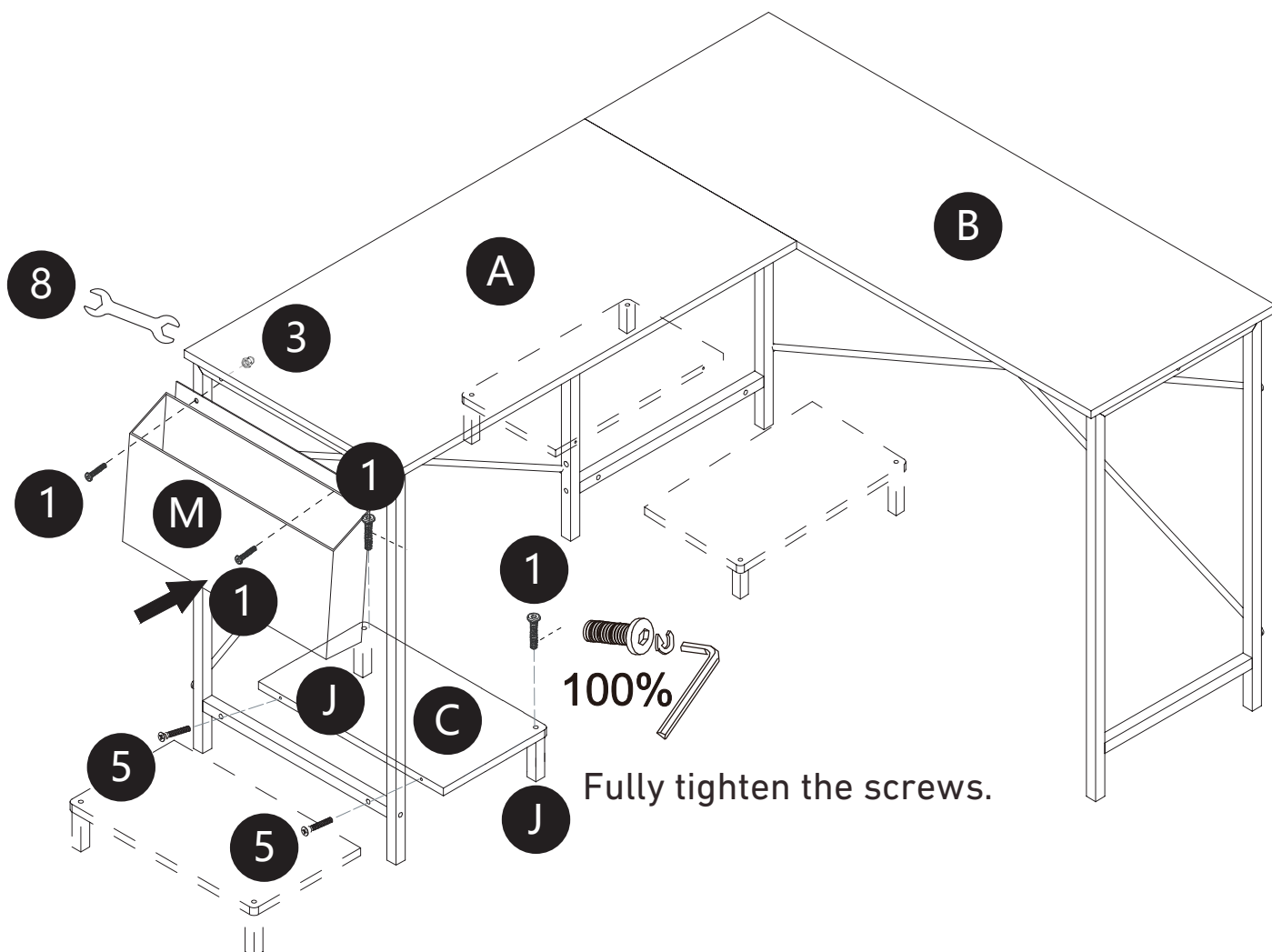

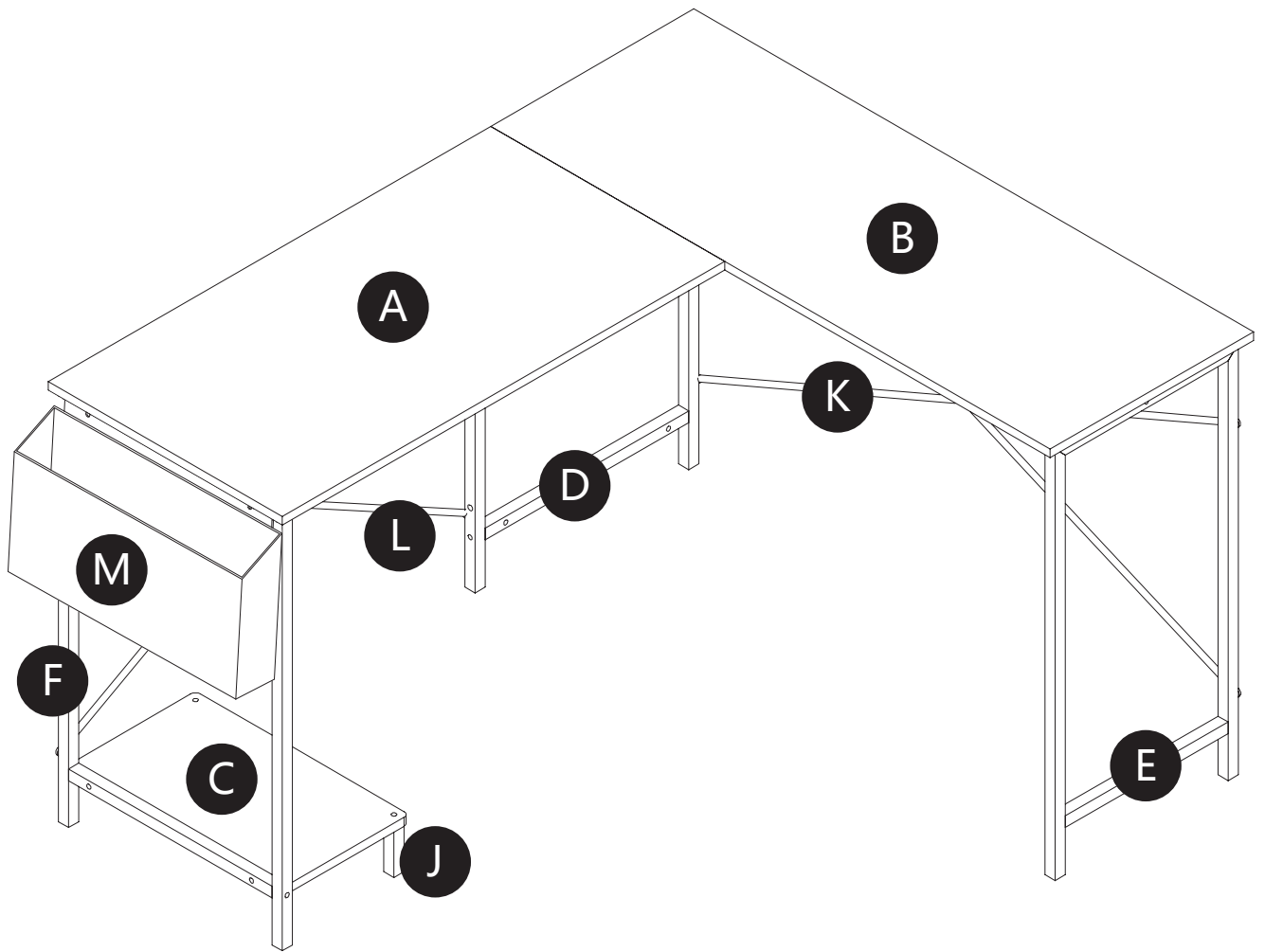

Step 7



Fully tighten all the screws.

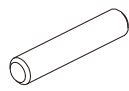

You can choose another installation method and customize the position of the storage components according to your preference.

Step 1

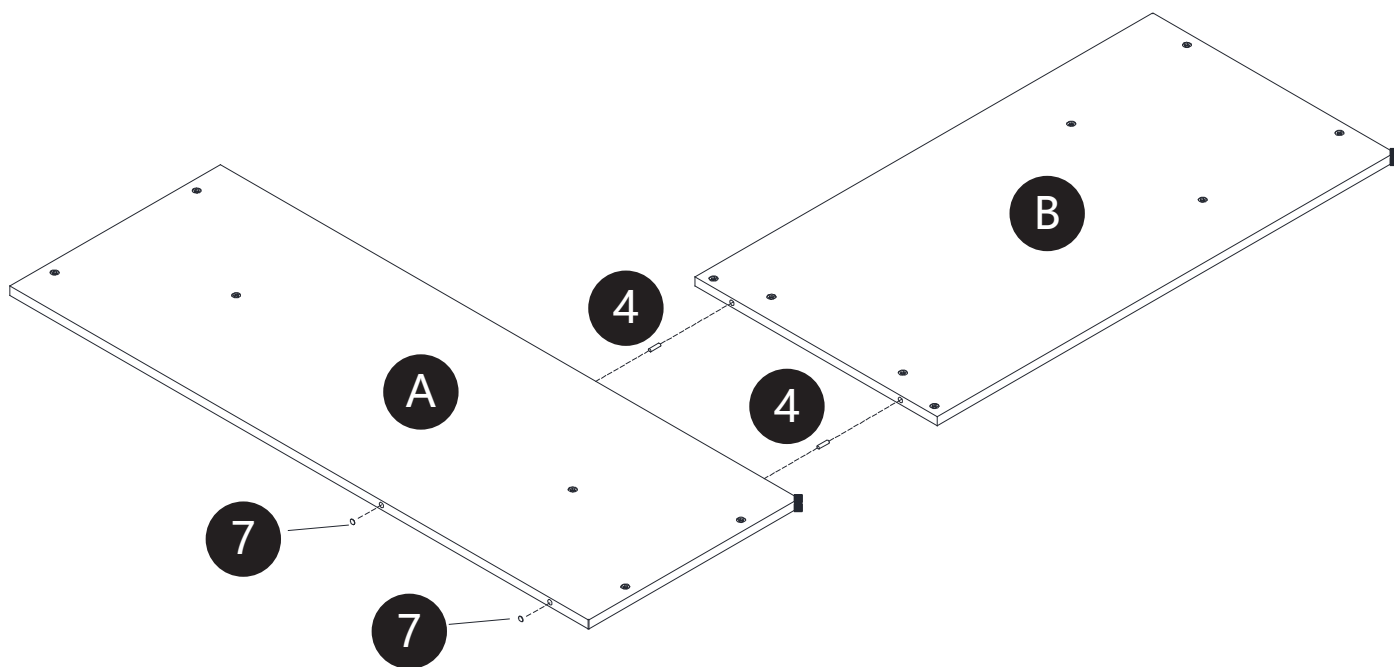
	
4 2pcs	7 2pcs



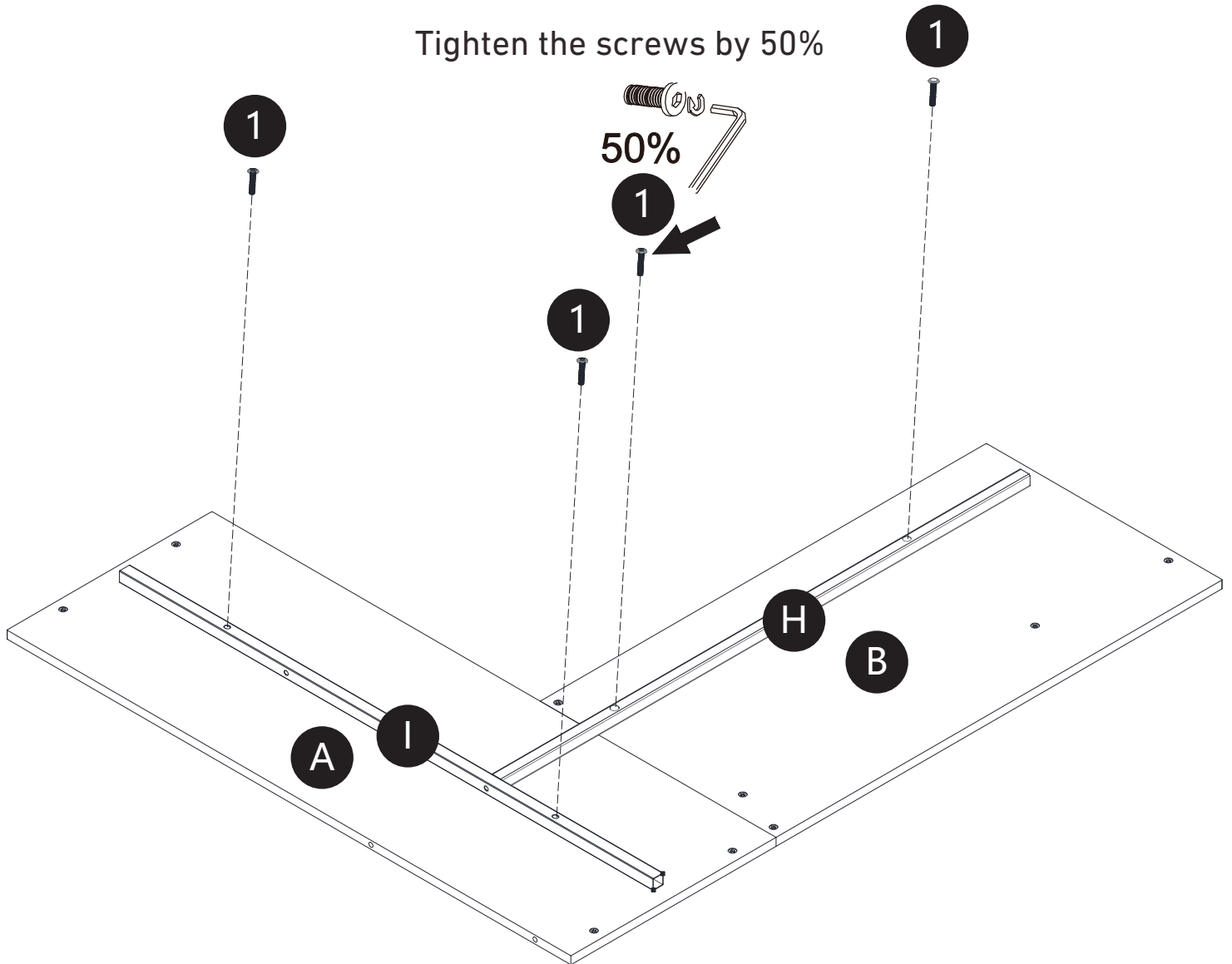

Step 2

	
1 4pcs	6 1pc



NOTE: Pay attention to the orientation of the holes on Crossbar **G**.

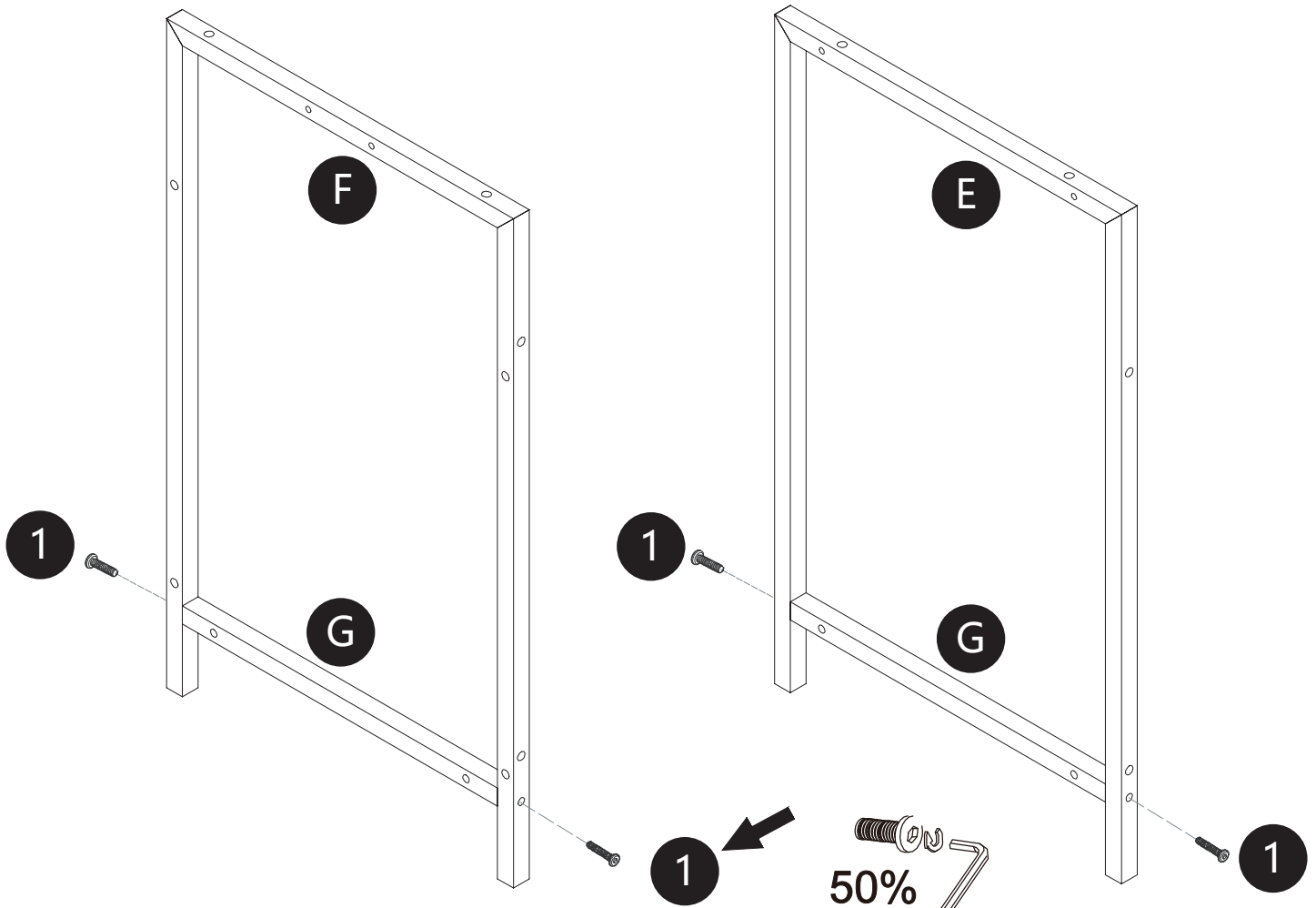

Step 3

	
1 4pcs	6 1pc



Tighten the screws by 50%

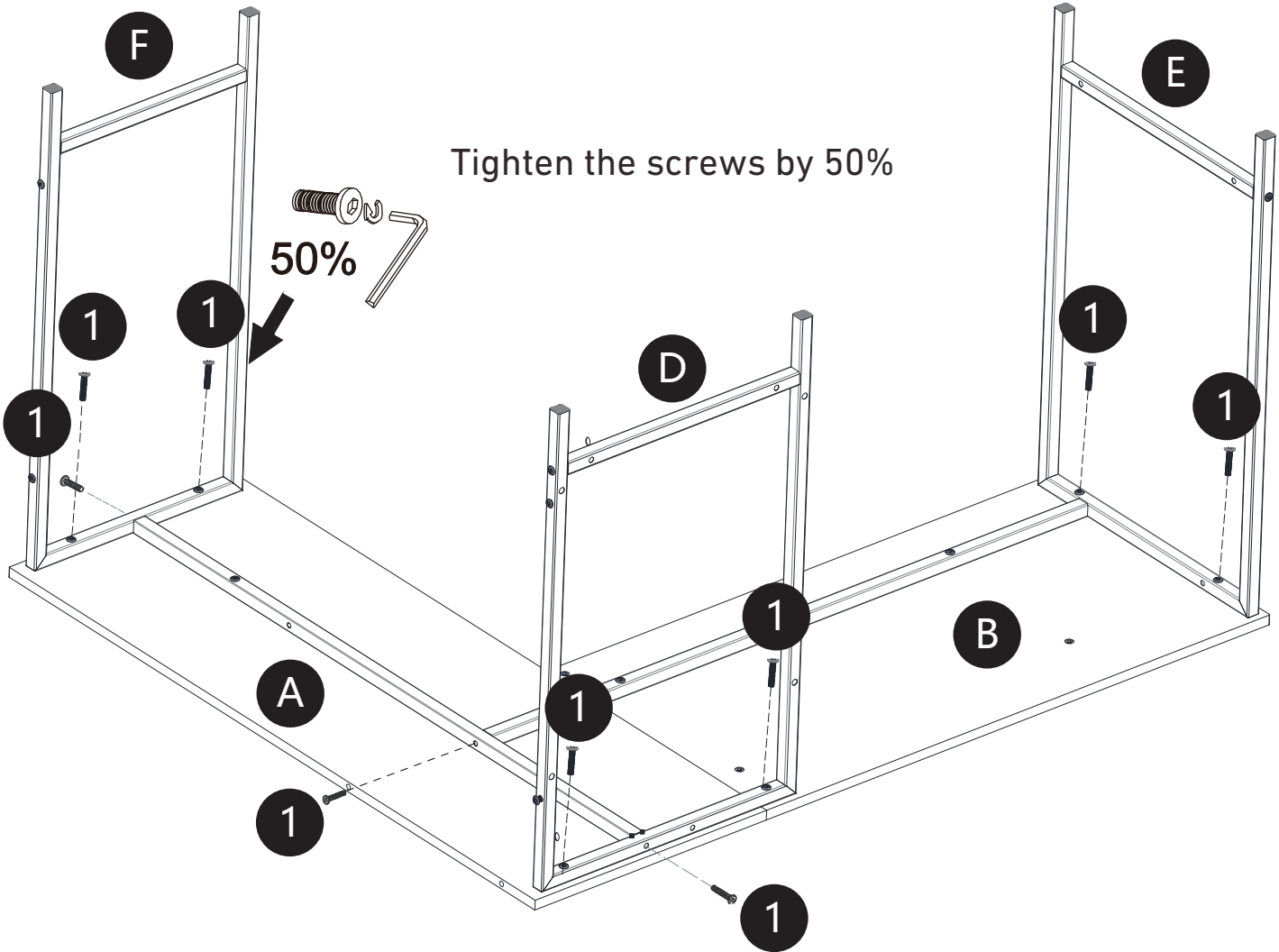

Step 4

	
1 9pcs	6 1pc



NOTE: Pay attention to the orientation of the holes on components **E**, **F**, and **D**.



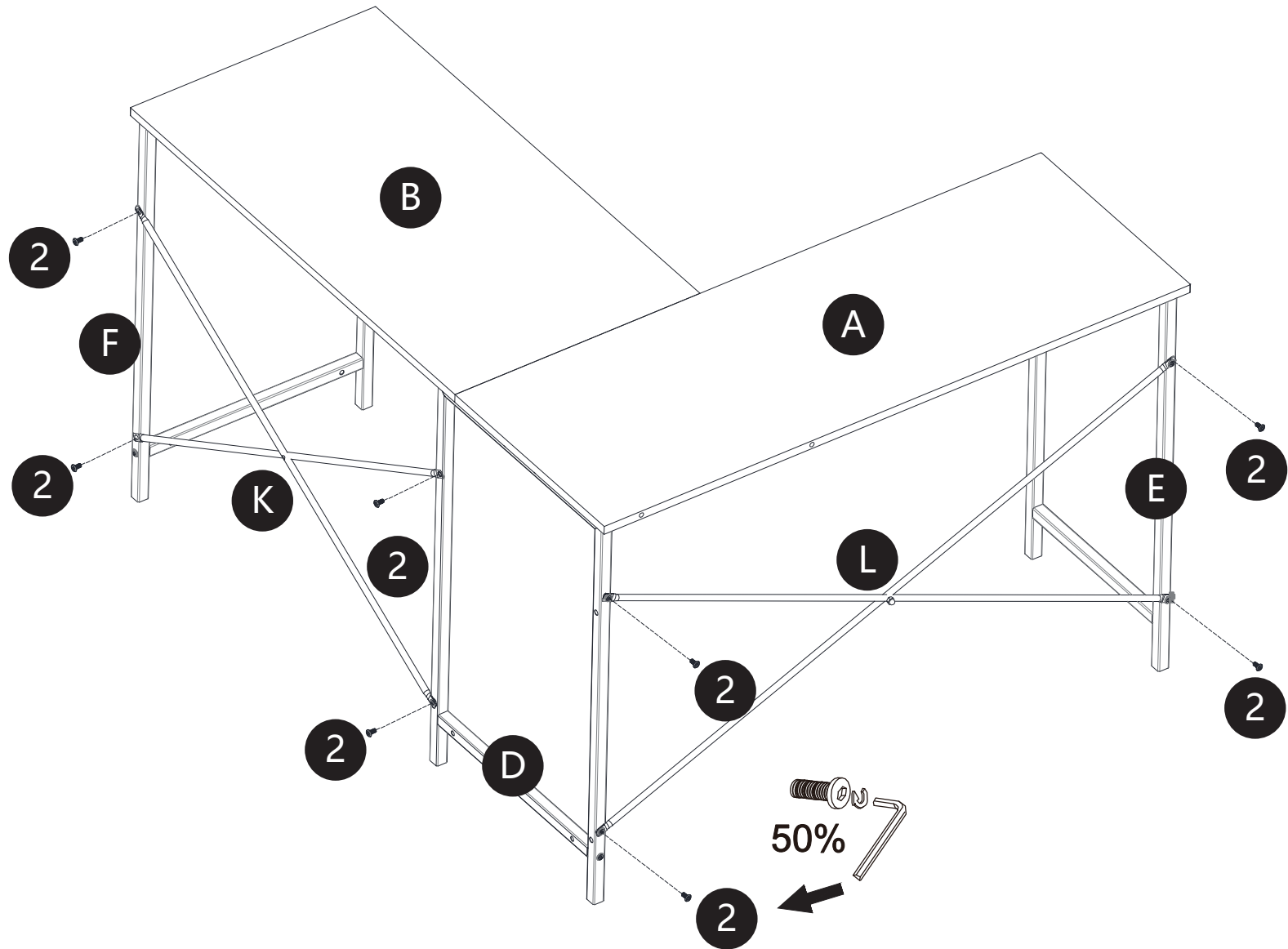

Step 5

	
2 8pcs	6 1pc

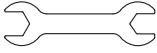

Tighten the screws by 50%

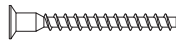
Step 6

				
8 1pc	1 4pcs	3 1pc	5 2pcs	6 1pc

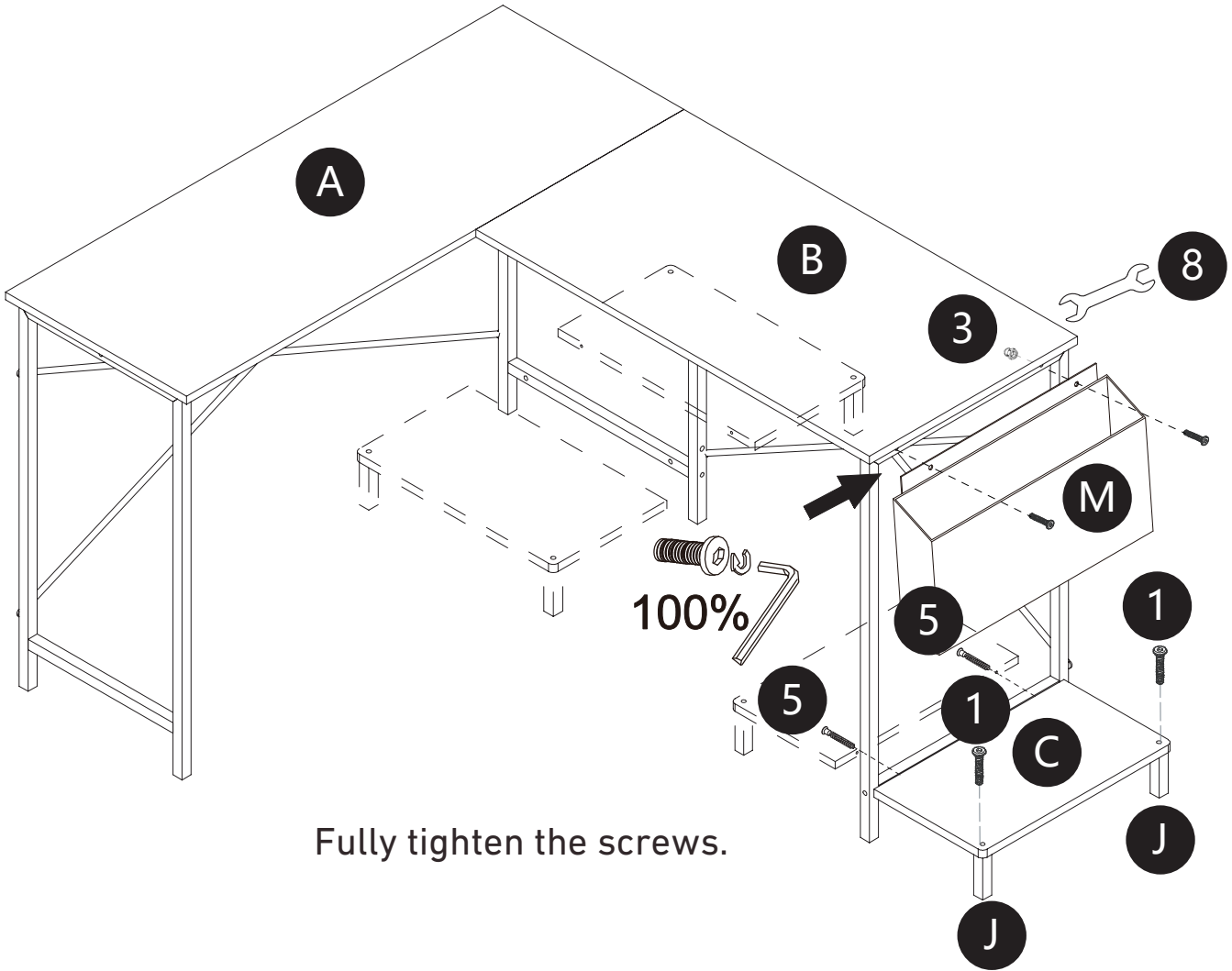

Step 7

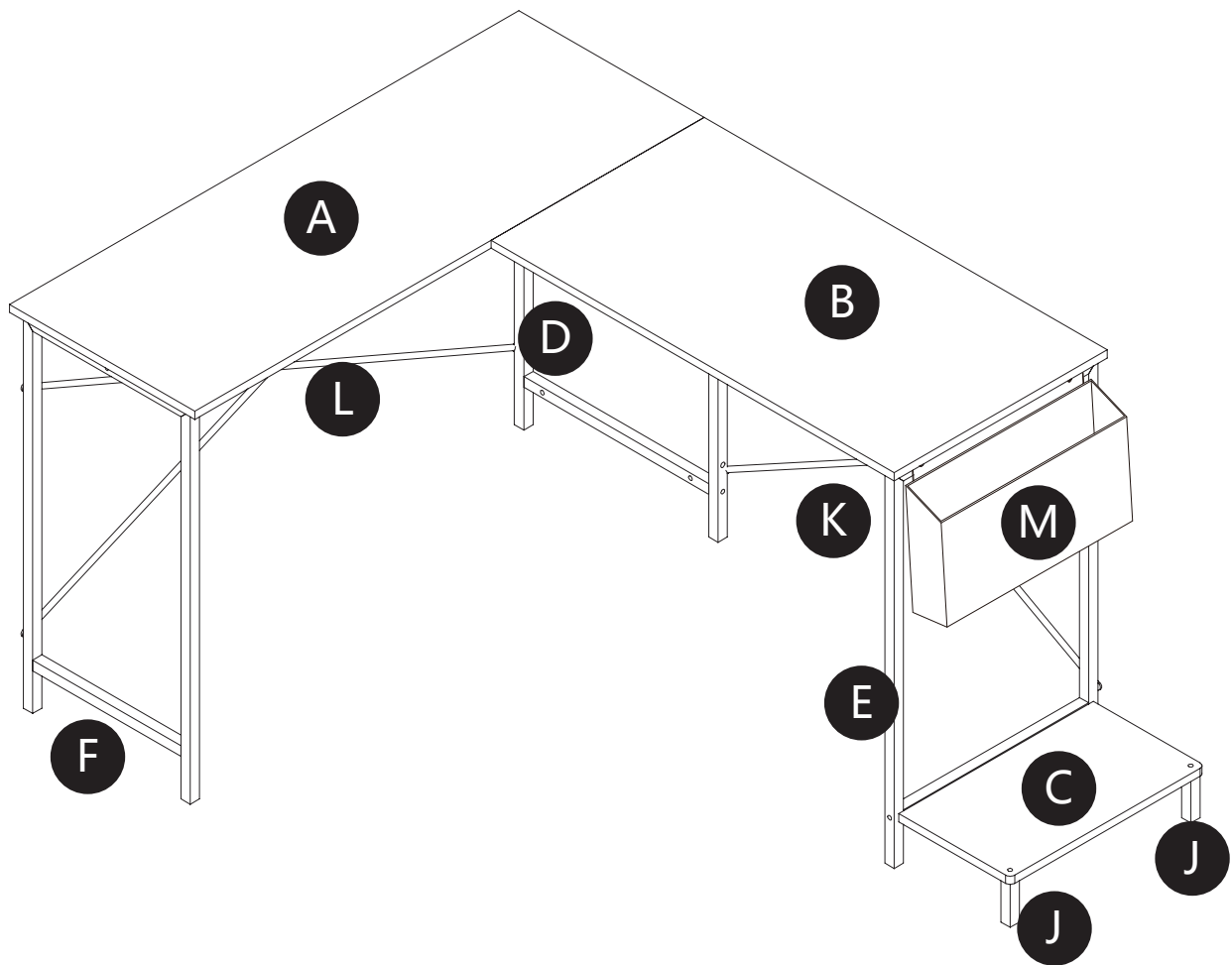

Fully tighten all the screws.

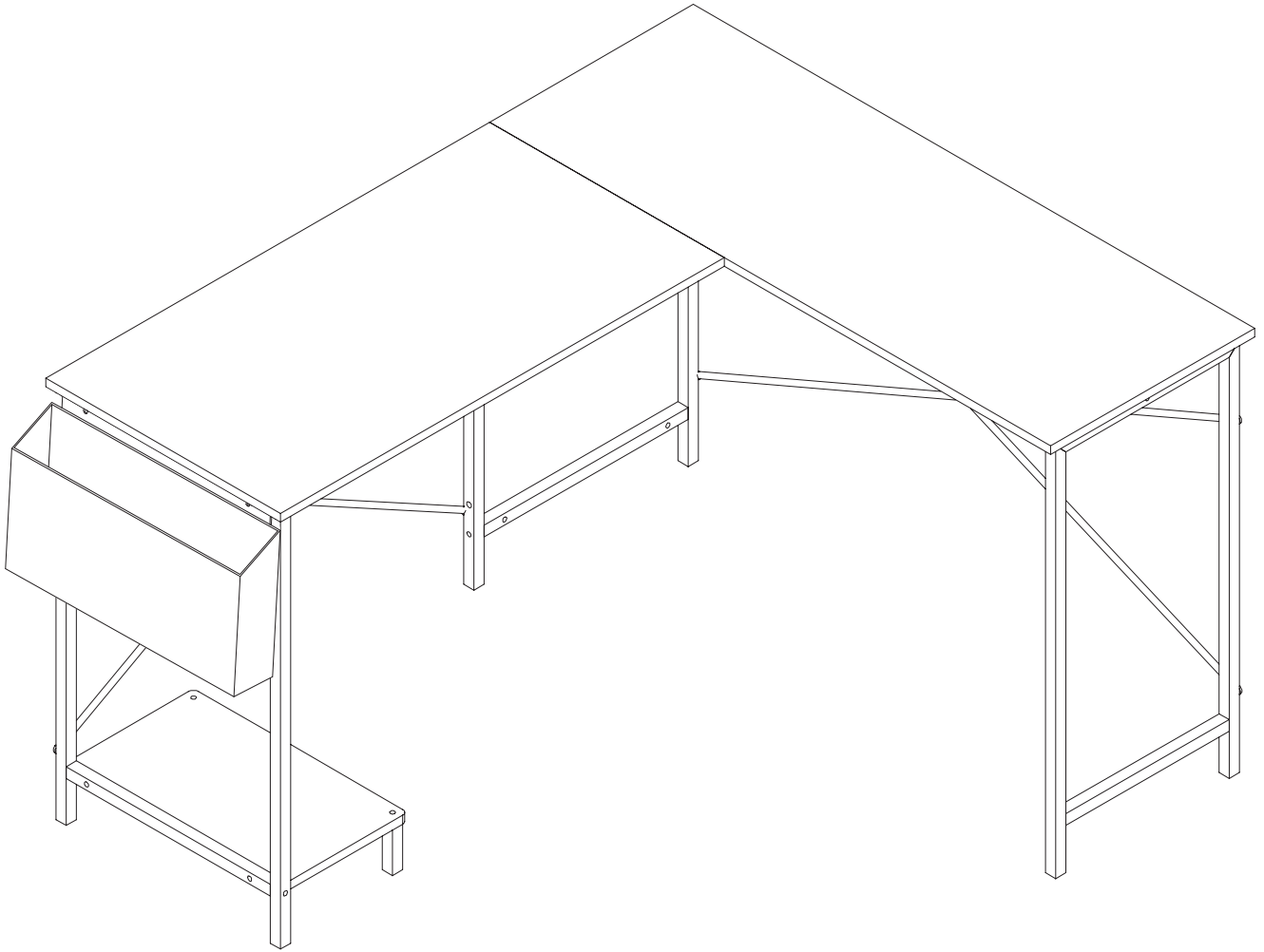

Technical Support

(909)637-7665 | (909)637-7593

Other Info

HJ-Customer-Service@outlook.com

Thank you for choosing this product. We strive to provide you with the best quality products and services in the industry. Should you have any issues, please don't hesitate to contact us.