

# ***Shark*** GENIUS™

S6002

---

OWNER'S GUIDE



# IMPORTANT SAFETY INSTRUCTIONS

## For Household Use Only

**WHEN USING YOUR SHARK® GENIUS™ HARD FLOOR CLEANING SYSTEM, BASIC SAFETY PRECAUTIONS SHOULD ALWAYS BE FOLLOWED, INCLUDING THE FOLLOWING:**

**READ ALL INSTRUCTIONS BEFORE USING YOUR SHARK GENIUS HARD FLOOR CLEANING SYSTEM.**

 **WARNING: DANGER OF SCALDING.**  
The steam emitted from the Steam Mop is very hot and may cause scalding. Please use caution when using the Steam Mop.

 **WARNING: KEEP STEAM MOP AWAY FROM CHILDREN.**

### **POLARIZED PLUG:**

This Steam Mop has a polarized plug (one blade is wider than the other). As a safety feature, this plug will fit into a polarized outlet only one way. If the plug does not fit fully into the outlet, reverse the plug. If it still does not fit, contact a qualified electrician. Do not attempt to defeat this safety feature.

 **WARNING:**  
**TO REDUCE THE RISK OF FIRE, ELECTRIC SHOCK OR INJURY:**

1. When in use never turn the Steam Mop over on its side or direct steam toward people, pets or plants.
2. Use the system only for its intended use.
3. **DO NOT** use for space-heating purposes.
4. **DO NOT** use outdoors.
5. **DO NOT** leave the Steam Mop unattended when plugged in. Always unplug the power cord from the electrical outlet when not in use and before servicing.
6. **DO NOT** allow the Steam Mop to be used by children. Close attention is necessary when used near children, pets, or plants.
7. Use only as described in this owner's guide.
8. Use only manufacturer's recommended accessories.
9. **DO NOT** use with damaged cord or plug. If Steam Mop is not working as it should or has been dropped, damaged, left outdoors, or dropped into water, return it to SharkNinja Operating LLC for examination and repair. Incorrect re-assembly or repair can cause a risk of electrical shock or injury when the Steam Mop is used.
10. To protect against a risk of electric shock, **DO NOT** immerse the Steam Mop in water or any other liquids.

11. **DO NOT** handle the plug or Steam Mop with wet hands or operate it without wearing shoes.
12. **DO NOT** pull or carry by cord, use cord as a handle, close a door on cord, or pull cord around sharp edges or corners. Do not run Steam Mop over cord. Keep cord away from heated surfaces.
13. **DO NOT** unplug by pulling on power cord. To unplug, grasp the plug not the power cord. Do not use extension cords or outlets with inadequate current-carrying capacity.
14. **DO NOT** put any objects into the steam nozzle openings. Discontinue use if the steam nozzle is blocked.
15. **DO NOT** put hands or feet under the Steam Mop. It gets very hot.
16. Use **ONLY** on flat, horizontal surfaces. **DO NOT** use on walls, counters, or windows.
17. **DO NOT** use on leather, wax-polished furniture, synthetic fabrics, velvet, or other delicate, steam-sensitive materials.
18. **DO NOT** add cleaning solutions, scented perfumes, oils, or any other chemicals to the water used in the Steam Mop as this may damage it or make it unsafe for use. If you live in a hard-water area, we recommend using distilled water in your Steam Mop.
19. **Never leave any Dirt Grip™ pad in one spot while using or storing for any period of time, as this may damage your surfaces.**
20. You can release the Dirt Grip pad after you have unplugged the Steam Mop and allowed it to cool.
21. When cleaning the exterior of the Steam Mop, unplug the power cord from the electrical outlet and clean the Steam Mop with a dry or damp cloth. Do not pour water or use alcohol, benzene, or paint thinner on the Steam Mop.
22. Extreme caution should be exercised when using the Steam Mop to clean stairs.
23. Never use Steam Mop without the Dirt Grip pad attached.
24. Keep your work area well lit.
25. Store Steam Mop indoors in a cool, dry place.
26. To avoid circuit overload, do not operate another appliance on the same socket (circuit) as the Steam Mop.
27. To avoid scalding injuries, always unplug and allow the Steam Mop to cool before removing or changing mop heads, accessories, or Dirt Grip pads.

**⚠ WARNING:** Your Steam Mop is designed to clean hard-floor surfaces that will withstand high heat. Do not use on unsealed wood or unglazed ceramic floors. On surfaces that have been treated with wax and on some no-wax floors, the sheen may be removed by the heat and steam action. It is always recommended to test an isolated area of the surface to be cleaned before proceeding. We also recommend that you check the use and care instructions from the floor manufacturer.

# SAVE THESE INSTRUCTIONS

Thank you for purchasing the Shark® Genius™ Hard Floor Cleaning System.

This Owner's Guide is designed to help you get a complete understanding of your new Genius Hard Floor Cleaning System. Please read it carefully and keep for future reference.

For a list of what is included with this model, refer to inside flap of box.

If you should have a question about your Shark Genius Hard Floor Cleaning System, please call Shark Customer Service at 1-800-798-7398.

The Shark Genius Hard Floor Cleaning System is a complete solution for both deep steam cleaning and quick everyday cleaning. Whether you need to clean up tough stains with the Steam Blaster™ or need to quickly handle a spill, our next-generation Genius Mop Head and Dirt Grip™ Pads work with both the Steam Mop and the Deluxe Spray Pocket Mop to offer the ultimate in versatility and efficiency, making cleaning simple, quick and easy.

#### **REGISTER YOUR PURCHASE:**

sharkclean.com  
1-800-798-7398

#### **RECORD THIS INFORMATION:**

Model Number: \_\_\_\_\_

Date of Purchase (Keep receipt): \_\_\_\_\_

#### **TECHNICAL SPECIFICATIONS:**

Voltage: 120V, 60 Hz  
Watts: 1050W  
Water Capacity: 350 ml (11.8 oz.)

#### **RECOMMENDED SCHEDULE FOR REPLACING WASHABLE DIRT GRIP PADS:**

Every 3 months

#### **FOR BEST CLEANING PERFORMANCE:**

See the Caring for Your Steam Mop section for more detail. Vacuum or sweep before mopping.



# Contents

**Thank you for  
purchasing  
the Shark®  
Genius™ Hard  
Floor Cleaning  
System.**

Getting Started.....	5
Assembling Your Steam Mop .....	6
Using Your Steam Mop .....	7
Automatic Steam Control.....	8
Caring For Your Steam Mop .....	9
Assembling and Using Your Deluxe Spray Pocket Mop .....	10
Ordering Additional Accessories.....	11
Troubleshooting Guide .....	12
Frequently Asked Questions.....	13
Warranty.....	14

## Getting Started

When assembling your Steam Mop there may be a little water in or around the water tank. This is because we test all our Steam Mops before you buy them, so you get a quality **Shark® Genius™ Hard Floor Cleaning System**.

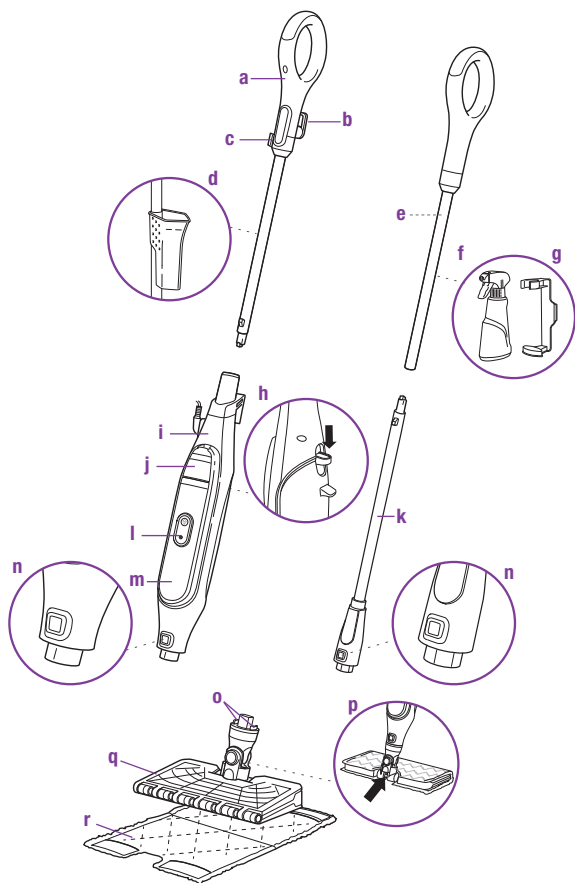

- a** Steam Mop Handle
- b** Quick-Release Cord Holder
- c** Cord Management Clip
- d** Filling Flask (clips to Steam Mop pole)
- e** Deluxe Spray Pocket Mop Handle
- f** Spray Bottle
- g** Spray Bottle Clip
- h** Pad Release Button
- i** Steam Mop Body
- j** Water Tank Lid
- k** Deluxe Spray Pocket Mop
- l** Steam Button
- m** Water Tank
- n** Mop Head Release Button
- o** Secondary Release Buttons
- p** Steam Blaster™ Nozzle
- q** Genius Mop Head
- r** Dirt Grip™ Pad

# Assembling Your Steam Mop

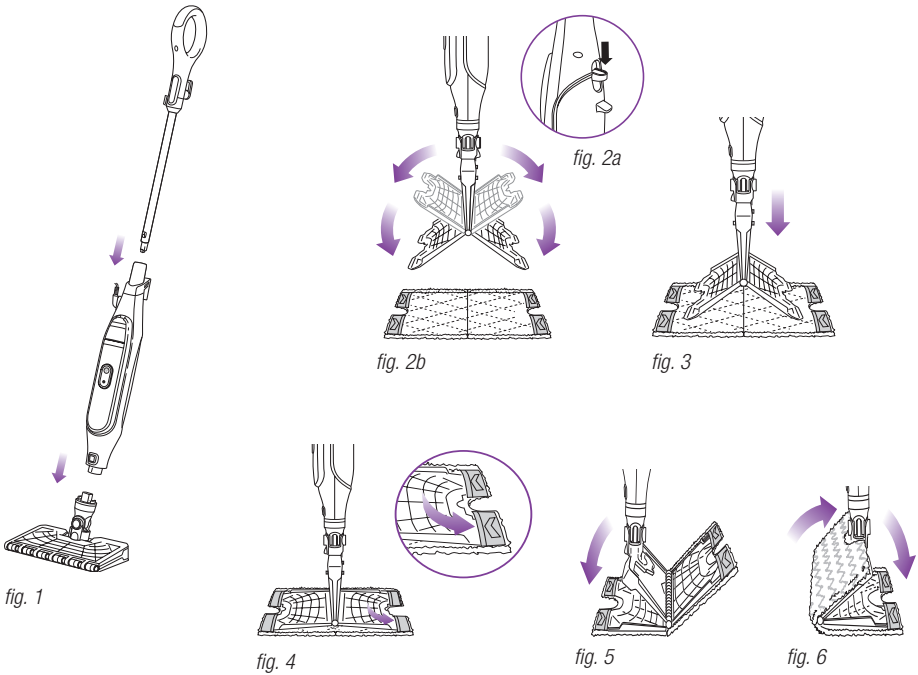

- ▲ WARNING:** Always make sure the Steam Mop is **UNPLUGGED** when not in use. Never fill the Steam Mop or attach the mop head when the Steam Mop is plugged into an electrical outlet. Unplug from the electrical outlet and allow to cool before you fill the mop, or attach or remove the head. To prolong the life of your Steam Mop, we recommend using distilled water. Make sure you add only water to the tank. Chemicals or cleaning solutions (including vinegar) may damage the Steam Mop and could be unsafe for you and your family.

## STEAM MOP ASSEMBLY

- 1 Insert the mop handle into the Steam Mop body. Push the mop handle in until you hear it click into place. (**fig. 1**)
- 2 Slide the Genius™ Mop Head into the Steam Mop body. Push until you hear it click securely into place. (**fig. 1**) To detach the Genius Mop Head, press the release button (**fig. 2a**) and slide off.

- 3 To attach the Dirt Grip™ pad, spread the pad on the floor with the pocket side up. Center the Genius Mop Head above the pad, then press the release button on the back of the Steam Mop body (**fig. 2a**). Both sides of the Genius Mop Head will drop open (**fig. 2b**). Slip the Genius Mop Head's four corner tabs into the four corner pockets of the pad (**fig. 3 and fig. 4**). Gently press one side of the Genius Mop Head to the floor until that side clicks into place (**fig. 5**). Repeat on the other side (**fig. 6**).
- 4 Pull down on the water tank lid to open (**fig. 7**).

- 5 Use the filling flask to pour water into the water tank (**fig. 8**). Water can be poured into the tank directly. Do not overfill past the water line on the fill flask. Press the water tank lid firmly to close it.

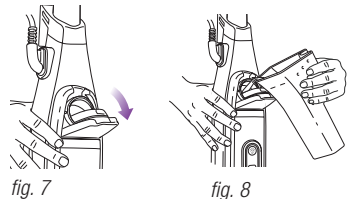

## Using Your Steam Mop

**IMPORTANT:** Make sure you do not use the Steam Mop without attaching a Dirt Grip™ pad and adding water to the water tank first. When you are using the Steam Mop for the first time, it might take longer than the normal 30 seconds to start steaming.

**IMPORTANT:** Do not use on unsealed wood or unglazed ceramic floors. On surfaces that have been treated with wax and on some no-wax floors, the sheen may be removed by the heat and steam action. Test an isolated area of the surface to be cleaned before proceeding. Check the use and care instructions from the floor manufacturer.

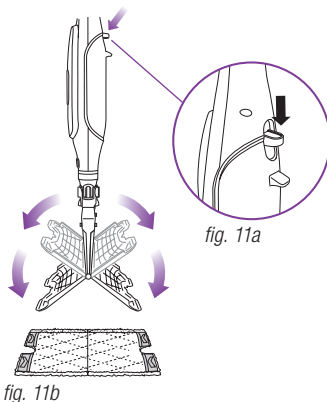
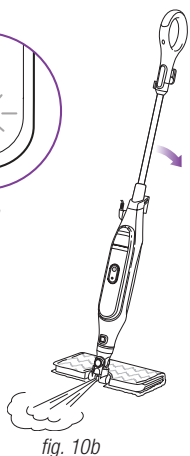
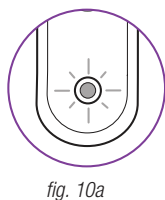
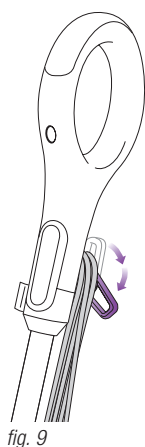

**NOTE:** To prolong the life of your Steam Mop, we recommend using distilled water.

**NOTE:** Sweep or vacuum your floors prior to cleaning with your Steam Mop.

- 1 Twist the Quick-Release Cord Holder to unwrap the power cord completely (**fig. 9**). Plug into an electrical outlet.
- 2 When it's first plugged in, the unit will be in Standby mode. When in Standby, the blue light below the steam button will blink (**fig. 10a**).
- 3 When ready to activate steam, press the steam button on the mop body to activate. The blue light will stop blinking and will glow steadily.
- 4 Clean your floors with a forward and backward motion.
- 5 When you need an extra burst of steam to clean a stuck-on stain, you can use the Steam Blaster™ feature. Flip the head over so that it is behind the mop body, then tilt the mop handle down. This will cause the the Steam Blaster (**fig. 10b**) to emit a concentrated blast of steam onto the stain.

⚠ **CAUTION:** While in Steam Blaster mode, do not leave stationary for more than one minute.

⚠ **CAUTION:** Do not scrub any one area for an extended period of time.

- 6 To stop the Steam Blaster spray, simply raise the handle. You can then flip the mop head back into its original position and continue cleaning.
- 7 When finished mopping, press the Steam Control button. The blue light will blink, indicating that the unit is in Standby mode. Once in Standby mode, unplug the unit.
- 8 To remove the Dirt Grip pad, simply lift the mop straight up by the handle until the Genius™ Mop Head is hanging straight down. Press the Release button on the back of the mop body (**fig. 11a**), and both sides of the head will drop open, releasing the pad (**fig. 11b**).
- 9 Once the Dirt Grip pad has been released, close the Genius Mop Head. To close, gently press one side of the Genius Mop Head to the floor until that side clicks into place. Repeat on the other side.
- 10 When the water tank is empty, the Steam Mop will stop producing steam. You can refill the water tank at any time as long as the Steam Mop is unplugged. Follow the water tank filling instructions on page 6.

**NOTE:** Please wait 2 to 3 minutes for the Steam Mop to cool off before switching the mop head. Never leave the Steam Mop with a damp/wet Dirt Grip pad on any floor for an extended period of time.

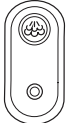

# Automatic Steam Control

SETTING	IDEAL FOR THESE SEALED SURFACES	RECOMMENDED USAGE
<b>1 setting</b> <b>Electronic Steam Control</b> 	Laminate Hardwood Marble Tile Stone	Cleaning sealed surfaces and large areas Basic, everyday cleaning Removing spots and smaller messes Cleaning moderate and heavy traffic areas
<b>Steam Blaster™</b>	For an extra burst of steam, you can use the Steam Blaster feature. Follow the instructions found on the “Using your Steam Mop” page.	

## TO SANITIZE\* WITH THE STEAM MOP USING THE GENIUS™ MOP HEAD AND THE DIRT GRIP™ PAD:

- 1 Attach a clean Dirt Grip pad to the mop head.
- 2 Press the steam button on the mop body to activate.
- 3 Wait 30 seconds for the unit to begin producing steam.
- 4 Start mopping on an appropriate sealed hard-floor surface with a forward and backward motion. After three minutes, your unit is ready to be used to sanitize.
- 5 Using a forward and backward motion, move the unit over the area you seek to sanitize. Repeat at least 15 times.

\* Sanitization studies were conducted under controlled test conditions. Household conditions and results may vary. With Genius Mop Head only.

# Caring for Your Steam Mop

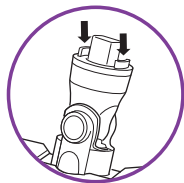

fig. 12



fig. 13

## AFTER USE AND STORAGE

- 1 Press the Steam Control button until the three lights below start to blink, indicating that you are in Standby mode. Unplug the cord from the outlet and place the Steam Mop into the upright position. Let it cool.
- 2 To remove the Dirt Grip™ pad, lift the Steam Mop straight up by the handle until the Genius™ Mop Head is hanging straight down. Press the Release button on the back of the mop body, and both sides of the Genius Mop Head will drop open, releasing the pad. Once the pad has been released, close the Genius Mop Head.
- 3 If the Genius Mop Head is not attached to the mop, the pad can still be removed. Press the two red secondary pad release buttons located on the sides of the Genius Mop Head post to release the pad (fig. 12).
- 4 Empty the water tank before storing. To empty the tank, hold the mop beside a sink. Open the water tank lid, then lean the unit over the sink. Let the water drain out, then close the lid.
- 5 To store the Steam Mop, wait until after it has cooled and the steam has been released. Then remove the Genius Mop Head and hang the mop by its handle on a large hook (not included) (fig. 13).
- 6 Store the filling flask by attaching it to the top handle pole of the Steam Mop.

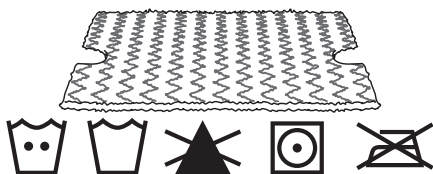

fig. 14



fig. 15

## DIRT GRIP PAD CARE INSTRUCTIONS

### Care

Machine-wash the Dirt Grip pads separately with warm water using liquid detergent.

### NEVER USE BLEACH, POWDERED DETERGENT, OR FABRIC SOFTENERS

as they may damage or leave a coating on the Dirt Grip pads that will reduce their cleaning performance and absorbency. Dirt Grip pads should be line-dried or tumble-dried on a low setting, as this will extend the life of the microfiber fabric (fig. 14).

Loose fibers can indicate wearing of the microfiber fabric. Do not pull the loose fibers, as this can cause the weave to come undone. Simply trim the loose fibers with scissors (fig. 15).

### Replacement Dirt Grip pads

For best cleaning results, we recommend replacing your Dirt Grip pads every 3 to 4 months following normal use. As with any fabric, dirt particles, grease, friction, and repeated washing can cause the fibers to break down, and you may notice an increase in the effort needed to push or pull the mop.

You can purchase replacement Dirt Grip pads and other accessories by visiting [sharkclean.com](http://sharkclean.com) or calling 1-800-798-7398.

### STEAM NOZZLE CARE

If you believe the main steam nozzle or the Steam Blaster™ nozzle is clogged, please contact Customer Service at 1-800-798-7398 or [consumer-services@sharkninja.com](mailto:consumer-services@sharkninja.com)

# Assembling and Using Your Deluxe Spray Pocket Mop

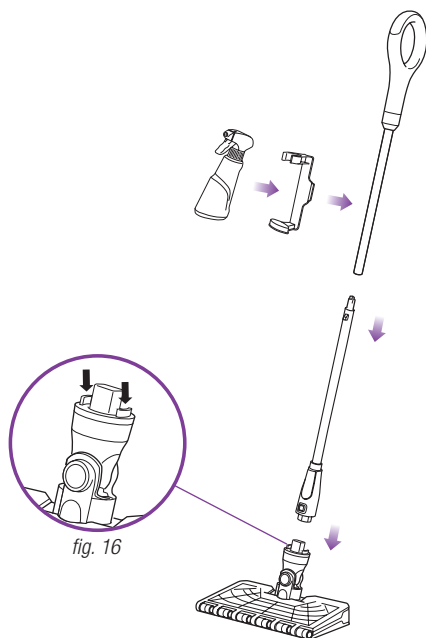

## ASSEMBLY





- 1** Slide the Genius™ Mop Head post into the Deluxe Spray Pocket Mop body until you hear it click securely into place. Next, slide the Deluxe Spray Pocket Mop handle into the mop body until it clicks securely into place. Attach the spray bottle and clip to the mop handle.
- 2** To attach the Dirt Grip™ pad, spread the pad on the floor with the pocket side up. Center the Genius Mop head above the pad, then press the pad release button on the back of the mop body (**fig. 16**). Both sides of the head will drop open. Slip the Genius Mop Head's four corner tabs into the four corner pockets of the pad. Gently press one side of the head to the floor until that side clicks into place. Flip the head over and repeat on the other side.
- 3** To remove the Dirt Grip pad, lift the mop straight up by the handle until the Genius Mop Head is hanging straight down. Press the pad release button on the back of the mop body, and both sides of the Genius Mop Head will drop open, releasing the pad.

- 4** To remove the Genius Mop Head, press the mop head release button on the mop body.
- 5** If the Genius Mop Head is not attached to the mop, the pad can still be removed. Press the two red secondary pad release buttons located on the sides of the Genius Mop Head post to release the pad.

## USE

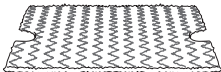
- 1** The Deluxe Spray Pocket Mop is a ready-to-grab floor cleaner that is great for quick, everyday cleaning jobs. Attach the Genius Mop Head and a pad, and you're ready to quickly wipe away spills and dirt.
- 2** The spray bottle clips onto the handle of the Deluxe Spray Pocket Mop for easy use, and can be stored there when not in use. The bottle comes pre-filled with cleaner. You can refill the bottle with the cleaner of your choice.

## Ordering Additional Accessories

ACCESSORY	
<p><b>Genius™ Mop Head</b></p> <p>Great for all-purpose cleaning. Get an extra boost for tough stains from the Steam Blaster™, and cut your cleaning time in half with the hands-free two-sided pad.</p>	 A rectangular mop head with a central handle and a small nozzle at the top.
<p><b>Dirt Grip™ Pad</b></p> <p>Double-sided pad. Easy, hands-free installation and removal. Washable and reusable.</p>	 A rectangular pad with a textured, zig-zag pattern.
<p><b>Triangle Scrubber Head</b></p> <p>Triangle shape is perfect for cleaning corners and hard-to-reach areas. Equipped with a Steam Blaster to help loosen stains and a deployable scrubber to tackle stuck-on spots.</p>	 A triangular scrubber head with a central handle and a small nozzle at the top.
<p><b>Triangle Scrubber Pad</b></p> <p>Ideal for cleaning corners and other hard-to-reach spaces. Easy to install and remove.</p>	 A triangular pad with a textured surface and a small nozzle at the top.
<p><b>Spray bottle and clip</b></p> <p>Add the cleaner of your choice to the spray bottle. The clip keeps it handy, right where you need it while you clean.</p>	 A spray bottle and a small clip.
<p><b>Filling Flask</b></p> <p>Filling line makes it simple and convenient to fill the water tank. Flask attaches to the handle for easy storage.</p>	 A tall, narrow flask with a handle and a filling line.

## Troubleshooting Guide

PROBLEM	POSSIBLE REASONS & SOLUTIONS
<b>The Steam Mop isn't producing any steam.</b>	<p>The Steam Mop should be securely plugged into an electrical outlet. Check your fuse or circuit breaker or try a different outlet.</p> <p>Make sure the water tank is full, the unit is plugged in, and the light below the Steam Button is solid.</p> <p>If the light below the Steam Button is not illuminated, try a different electrical outlet.</p> <p>If light below the Steam Button is blinking, the Steam Mop is in Standby.</p> <p>If the light below the Steam Button is solid, wait 30 seconds for the unit to warm up.</p> <p>If after following the above steps the Steam Mop still does not produce any steam, contact Customer Service at 1-800-798-7398 or <a href="mailto:consumer-services@sharkninja.com">consumer-services@sharkninja.com</a></p>
<b>The Steam Mop is producing intermittent steam.</b>	<p>Make sure the water tank is full.</p>
<b>I am getting streaky/cloudy floors.</b>	<p>The Dirt Grip™ pad might be dirty. If it is, flip it over to the clean side or change it entirely. If you washed the Dirt Grip pad with powdered detergent, then it could be damaged and require replacement.</p> <p>This could also be an indication of soap or grease residue that has accumulated on the floor. As the Steam Mop uses only a small amount of water, it may not be enough to rinse off the accumulation of residue that the steam is bringing to the surface. We suggest rinsing the floor with nothing but water, letting it dry, and then steam mopping again with a clean Dirt Grip pad. One or more rinses will generally remove the residue.</p> <p>A more stubborn case may require you to rinse the floor with a mix of one part vinegar and two parts water* (but DO NOT put any cleaning solutions or chemicals into the Steam Mop's water tank.)</p> <p>*Please consult your flooring manufacturer's care and maintenance instructions before applying any cleaning products or solutions including vinegar.</p>
<b>It's really hard for me to push/pull the mop.</b>	<p>The mop might be hard to push/pull if the Dirt Grip pad isn't wet enough. It should get easier to push/pull the mop after it's been running for a few minutes.</p> <p>An overly dirty pad could also result in a harder push/pull experience. We recommend flipping the pad over or using a clean pad.</p>

## Frequently Asked Questions

QUESTION	ANSWER
Can I use the Steam Mop on carpets?	No, the Steam Mop is not designed for carpet cleaning.
What surfaces can I use the Steam Mop on?	<p>The Steam Mop is designed for use on all sealed hard-floor surfaces. We recommend that you first test an isolated area of the floor surface to be cleaned as well as review the use and care instructions from your floor manufacturer.</p> <p><b>⚠ WARNING: Do not use on leather, wax-polished furniture, synthetic fabrics, velvet, or other delicate, steam-sensitive materials.</b></p> <p><b>NOTE:</b> On surfaces treated with wax and on some no-wax floors, the sheen may be removed by the heat or steam action of the unit. Test an isolated area of flooring first to see if sheen is affected.</p>
Can I put something other than water in the water tank of the Steam Mop?	DO NOT add cleaning solutions, scented perfumes, oils, or any other chemicals to the water used in this appliance, as this may damage the unit or make it unsafe for use. We recommend using distilled water in your Steam Mop.



## ONE (1) YEAR LIMITED WARRANTY

**SharkNinja Operating LLC** warrants this product to be free from defects in material and workmanship for a period of one (1) year from the date of the original purchase, when utilized for normal household use, subject to the following conditions, exclusions, and exceptions.

If your appliance fails to operate properly while in use under normal household conditions within the warranty period, return the complete appliance and accessories, freight prepaid. For assistance with warranty service options or customer support, please call Customer Service at 1-800-798-7398 or visit [sharkclean.com](http://sharkclean.com).

If the appliance is found to be defective in material or workmanship, **SharkNinja Operating LLC** will repair or replace it free of charge. Proof of purchase is required and a fee of \$19.95 will apply to cover the cost of return freight.\*

The liability of **SharkNinja Operating LLC** is limited solely to the cost of the repair or replacement of the unit at our option. This warranty does not cover normal wear of parts and does not apply to any unit that has been tampered with or used for commercial purposes. This limited warranty

does not cover damage caused by misuse, abuse, negligent handling, or damage due to faulty packaging or mishandling in transit. This warranty does not cover damage or defects caused by or resulting from damages from shipping or from repairs, service, or alterations to the product or any of its parts that have been performed by a repair person not authorized by **SharkNinja Operating LLC**.

This warranty is extended to the original purchaser of the unit and excludes all other legal and/or conventional warranties. The responsibility of **SharkNinja Operating LLC** warranty, if any, is limited to the specific obligations expressly assumed by it under the terms of the limited warranty. In no event is **SharkNinja Operating LLC** liable for incidental or consequential damages of any nature whatsoever. Some states/provinces do not permit the exclusion or limitation of incidental or consequential damages, so the above may not apply to you.

This warranty gives you specific legal rights, and you may also have other rights which vary from state to state or province to province.

**\*Important: Carefully pack item to avoid damage in shipping. Be sure to include proof of purchase date and to attach tag to item before packing with your name, complete address, and phone number with a note giving purchase information, model number, and what you believe is the problem with the item. We recommend you insure the package (as damage in shipping is not covered by your warranty). Mark the outside of your package "ATTENTION CUSTOMER SERVICE".**

---

## Product Registration

Please visit [sharkclean.com](http://sharkclean.com) or call **1-800-798-7398** to register your new Shark® product within ten (10) days of purchase. You will be asked to provide the store name, date of purchase, and model number, along with your name and address.

The registration will enable us to contact you in the unlikely event of a product safety notification. By registering, you acknowledge you have read and understood the instructions and the accompanying warnings set forth in this owner's guide.

# Questions or Problems?

**CALL US.**  
We are here to  
help with our  
hassle-free  
return service.

Toll-Free Customer Support Telephone:

Mon-Fri, 8am-10pm ET, and Sat & Sun, 9am-6pm ET

**1-800-798-7398**

 [consumer-services@sharkninja.com](mailto:consumer-services@sharkninja.com)



SharkNinja Operating LLC  
U.S.: Newton, MA 02459  
Canada: Ville St. Laurent, Québec H4S 1A7  
1-800-798-7398  
[sharkninja.com](http://sharkninja.com)

COPYRIGHT © 2016 SharkNinja Operating LLC  
Shark is a registered trademark of SharkNinja Operating LLC.  
Genius, Dirt Grip and Steam Blaster are trademarks of SharkNinja Operating LLC.  
S800Z, 40, B, 16009, 1  
PRINTED IN CHINA. Illustrations may differ from actual product. We are constantly striving to improve our products;  
therefore the specifications contained herein are subject to change without notice.  
For SharkNinja U.S. Patent information, visit [sharkninja.com/USPatents](http://sharkninja.com/USPatents)