

# ASSEMBLY INSTRUCTIONS

## BED - KING

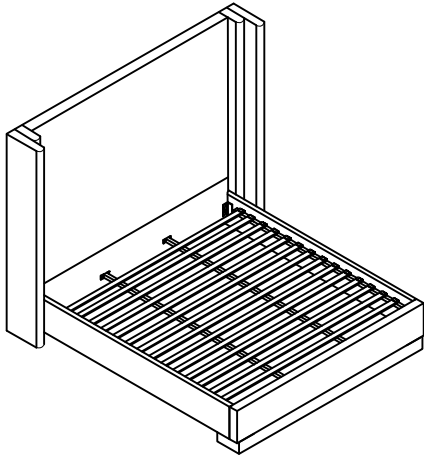

+ Do Not Use Power Tools



+ Suggested Adults

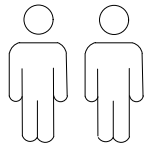

NOTE:

- 1 Read instructions cover to cover.
- 2 Save all packaging until assembly is completed.

### 1 IMPORTANT SAFETY INFORMATION

Do not assemble the product if any of the following parts arrived damaged:

- Part #③ -Side Rails
- Part #④ -Center Support Bar
- Part #⑤ -Support Legs
- Part #⑦ -Slats joint

### 2 IMPORTANT ASSEMBLY INFORMATION

Assembly Step ② Ensure the side rail bracket is fully hooked onto bolt **A** loosely threaded with both washers on the **OUTSIDE** of the bracket first, then proceed to fully tightening all 4 corners.

\*Slats come packed in the bottom of headboard carton.

### + Parts Included

① Head Board (1pc)

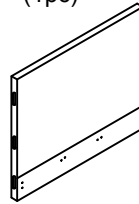

② Foot Board (1pc)

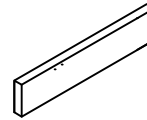

③ Side Rails (2pcs)

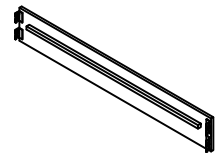

④ Center Support Bar (2pcs)



⑤ Support Legs (4pcs)

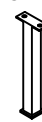

⑥ Foot board Base (1pc)

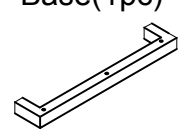

⑦ Slats joint (1set=13pcs)

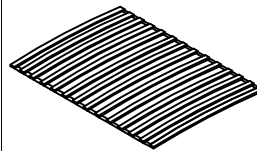

⑧ Left wing (1pc)

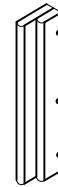

⑨ Right wing (1pc)



\*Slats come packed in the bottom of headboard carton.

### + Hardware Included

A Bolt M8\*40mm (32pcs)



B Bolt M8\*75mm (6pcs)



C Spring Washer (16pcs)



D Bolt M8\*125mm (3pcs)



E Flat Washer  $\phi 20$ (35pcs)



F M8 Allen Key (1pc)



G Flat Washer  $\phi 22$ (6pcs)



H Nut M8\*13mm (8pcs)



I Spanner (1pc)



# ASSEMBLY INSTRUCTIONS

## BED - KING

