

Fire Pit

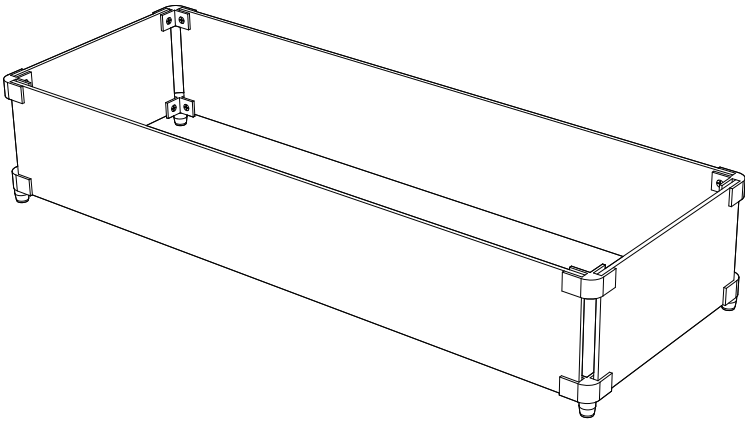

Glass Wind Guard



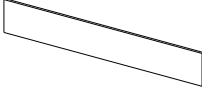
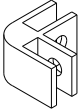
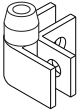

4327FTB-GWG-23

Instructions

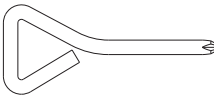
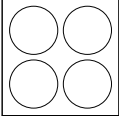
Paking Lists

Part	Img	Part Name	Qty
A		Short Glass	2 PCS
B		Long Glass	2 PCS
C		Top Corner Connector	4 PCS
D		Bottom Corner Connector	4 PCS
E		M8 x 10	16 PCS
F		Hand Screw Driver	1 PC
G		Rubber Mat	1 PC

Extra





Part	Description	Description	Qty
E		M8 x 10	2PCS
G		Rubber Mat	1PC

WARNING: Failure to locate parts in accordance with these diagrams, or failure to use special parts provided with this equipment, may result in property damage or personal injury.

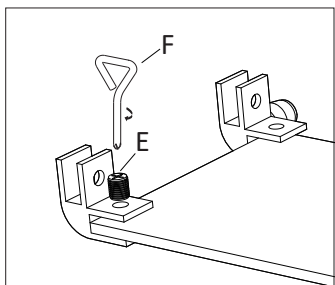
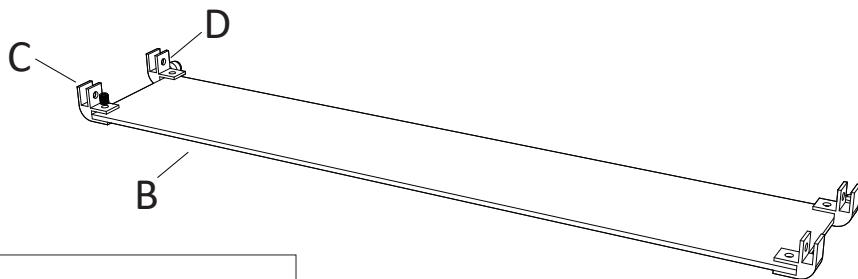
Step1:Fasten the top corner connector(C) and bottom corner connector(D) to the long glass(B) with screws(E).

Note: Please tighten the screws.







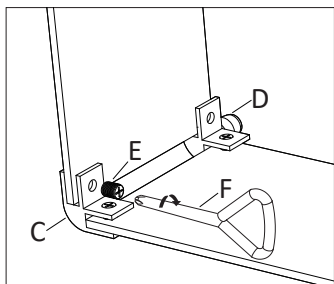
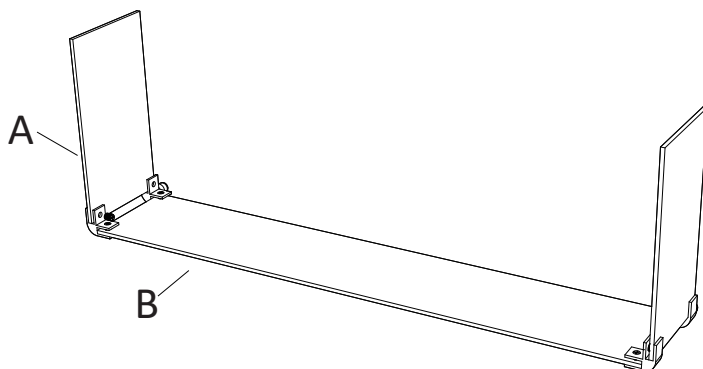

- B  Long Glass
- C  Top Corner Connector
- D  Bottom Corner Connector
- E  M8 x 10
- F  Hand Screw Driver

Step2:Fasten the short glass(A) with screws(E) on the top corner connector(C) and the bottom corner connector(D).

Note: Please tighten the screws.







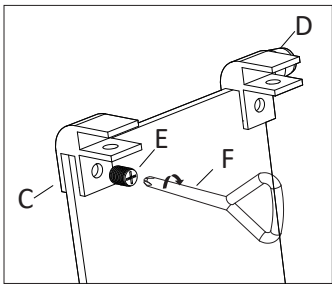
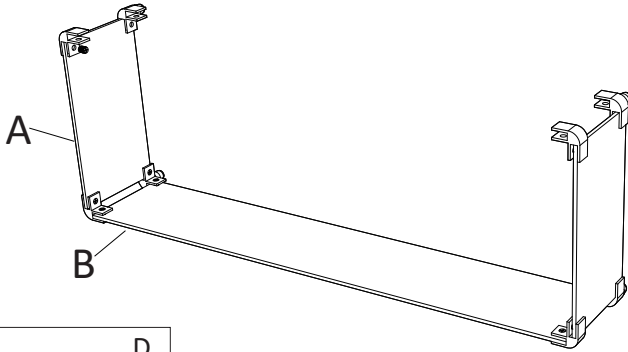

- A  Short Glass
- B  Long Glass
- C  Top Corner Connector
- D  Bottom Corner Connector
- E  M8 x 10
- F  Hand Screw Driver

Step3:Fasten the top corner connector(C) and bottom corner connector(D) to the short glass(A) with screws(E).

Note: Please tighten the screws.







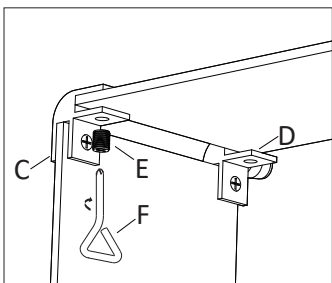
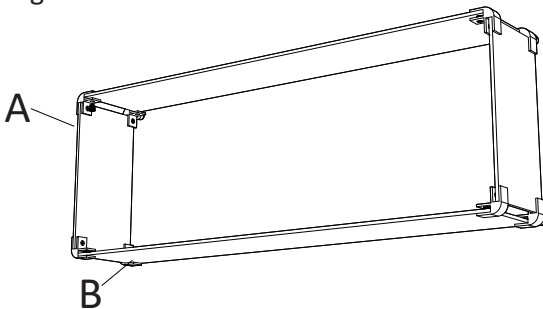

- A  Short Glass
- B  Long Glass
- C  Top Corner Connector
- D  Bottom Corner Connector
- E  M8 x 10
- F  Hand Screw Driver

Step4:Fasten the other long piece of glass(B) with screws(E) on the top corner connector(C) and the bottom corner connector(D).

Note: Please tighten the screws.



- A  Short Glass
- B  Long Glass
- C  Top Corner Connector
- D  Bottom Corner Connector
- E  M8 x 10
- F  Hand Screw Driver

Step5: Glue the rubber mat(G) to bottom corner connector(D) and press firmly.

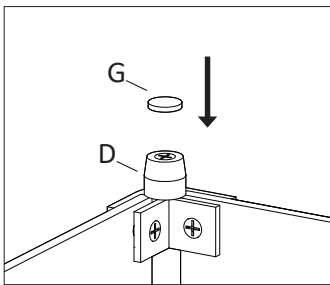
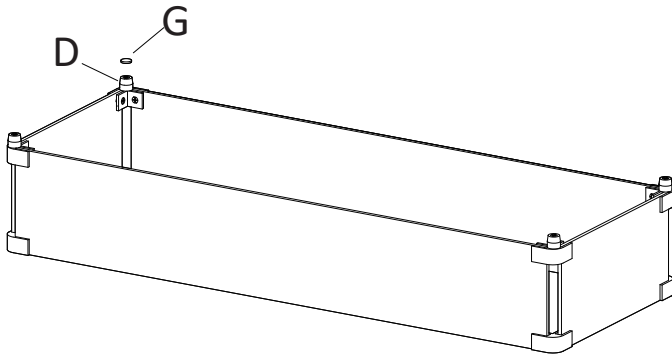

D



Bottom Corner Connector

G



Rubber Mat

Warning

Never place your wind guard directly on the fire pit insert.

Always ensure the rubber feet are used.

Always ensure the silicon insert is on the set screws.

Always ensure there is a 1/2gap between the glass panels.

Always check the glass panels for cracks. DO NOT use glass panels with a crack.

Maintenance:

Clean the glass 2-3 times per season or as needed.

CARE AND MAINTENANCE

Follow the instruction for the material of your special product to make sure that it stays in the best shape for as long as possible. The information below is only intended as a general guideline. For more information, please contact us.

- Only need to rinse it thoroughly with clean water to wash away dirt and grime. Never use abrasive cleansers on the furniture, since it can attack the surfaces and leave behind scratch marks.
- For the stubborn grime and stains, just use a soft sponge and mild soapy water and then dry it with a cloth or paper towel.
- Check the stability of the screws, nuts and nut caps prior to each use. Tighten up them after one to two month's use whenever required.
- Avoid improper use, and be careful not to scratch or damage the surface with sharp objects.
- When you move your furniture, make sure you lift it rather than pulling or pushing it to avoid damaging the floor, legs and mounting.

www.alaulm.com

Make Your Life Better.

