

For your safety, please secure the storage rack to the wall after installation to prevent tipping. Thank you for your cooperation.

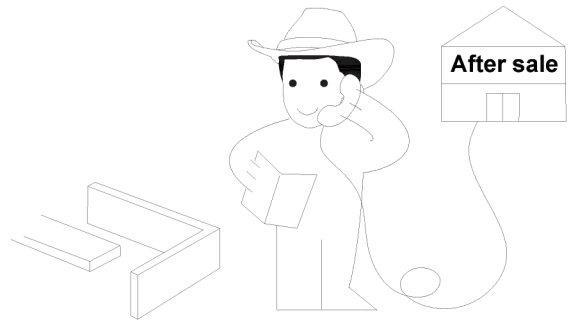

A×2pcs

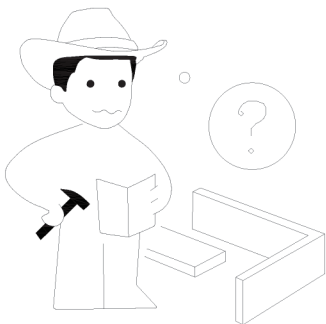
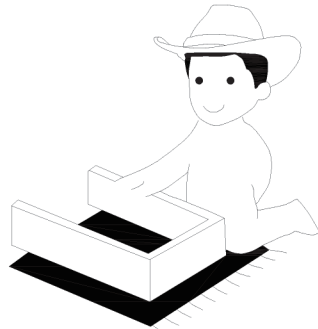
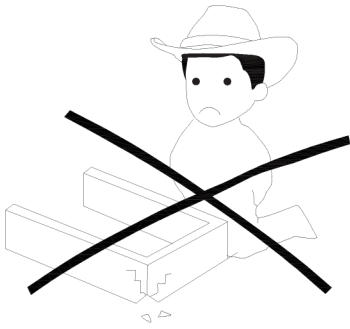
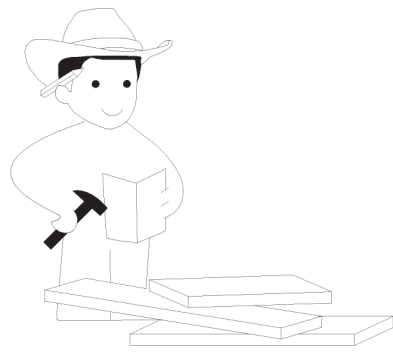
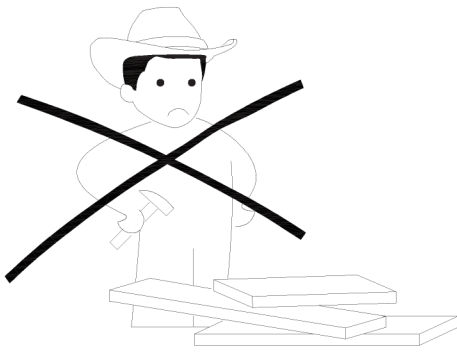
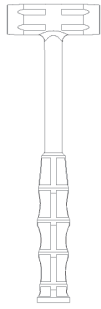
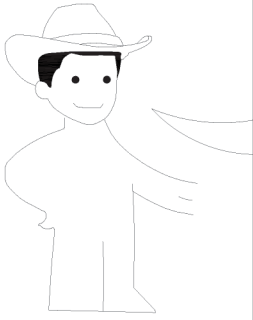
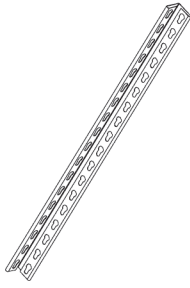

B×2pcs

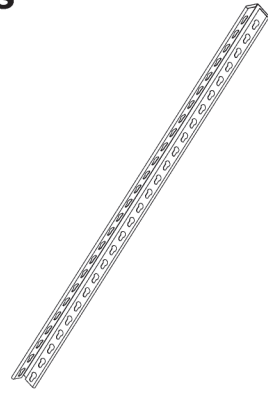

C×6pcs

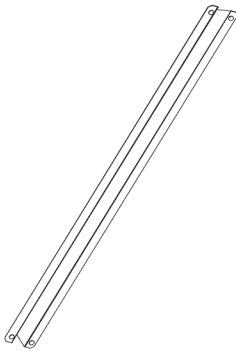

D×6pcs

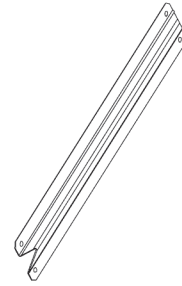

E×3pcs

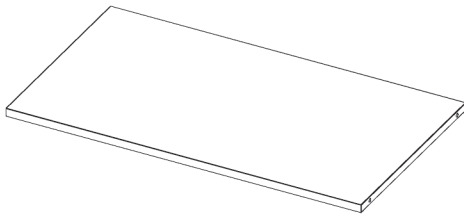

F×1pcs

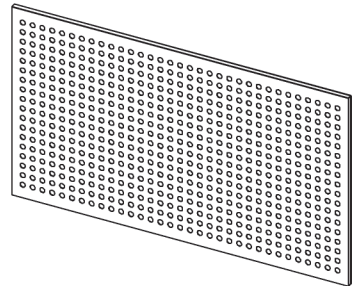

G×4pcs

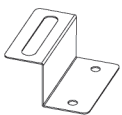

H×4pcs

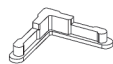

I×4pcs

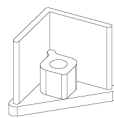

J×2pcs

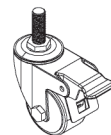

K×2pcs

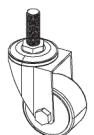

L×4pcs



M×4pcs



N×2pcs

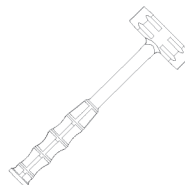
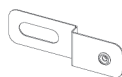

1

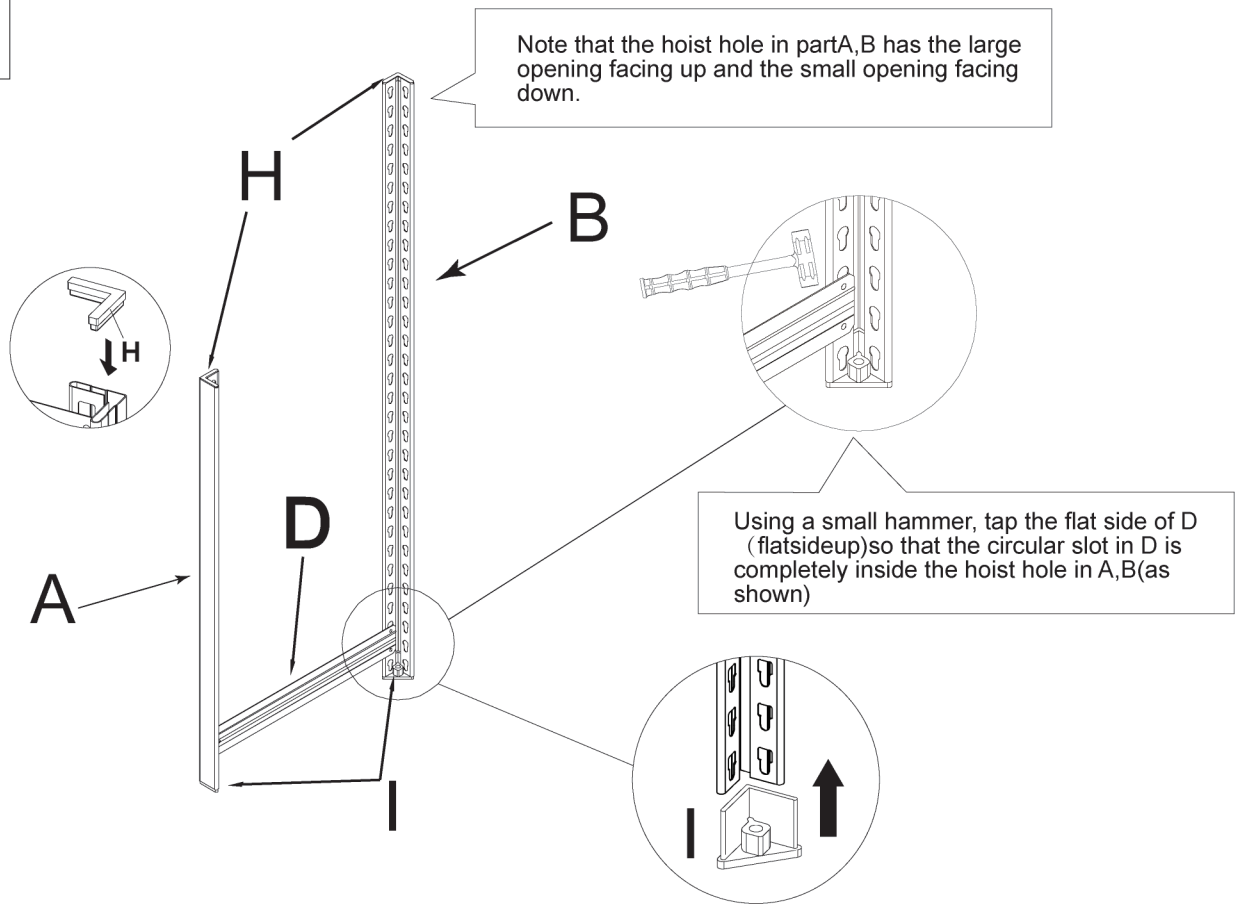

2

Installation Note:
Component D on this layer must be fixed to the top grid of Component A to prevent interference with subsequent processes.

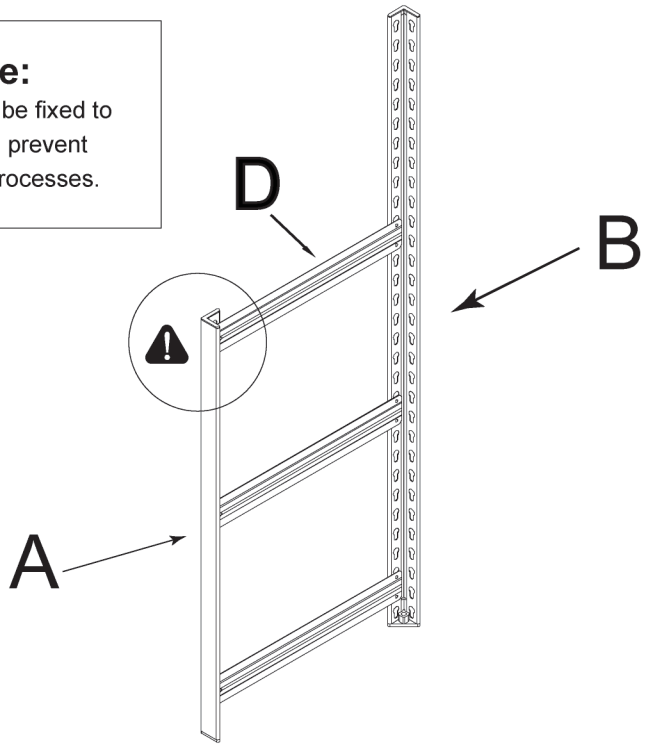

3

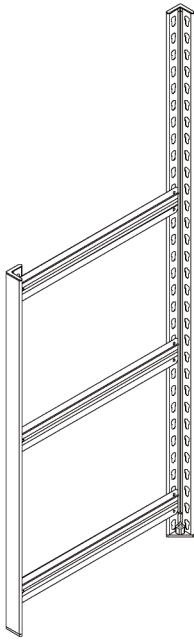

Install the other lower side frame in the same way, taking care to keep the installation height consistent

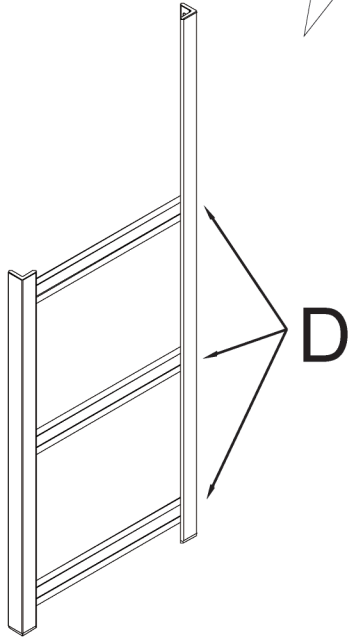

4

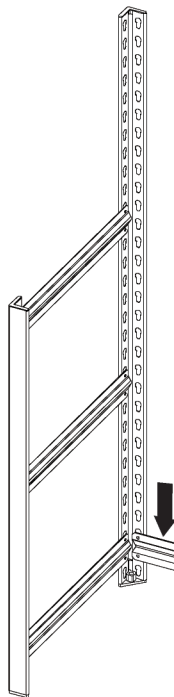

Using a small hammer, tap the flat side of C (flat side up) so that the circular slot in part C is completely inside the hoist hole in part B (as shown), and note that the hoist hole in part

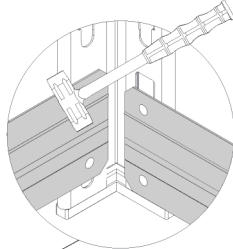
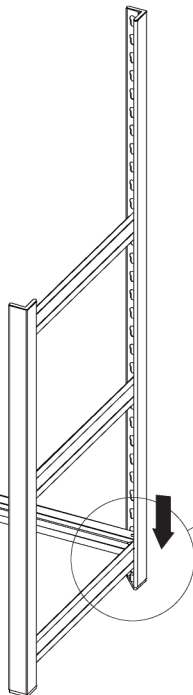

Note that the planes are aligned here

5

Installation for the second and third floors follows the same procedure.

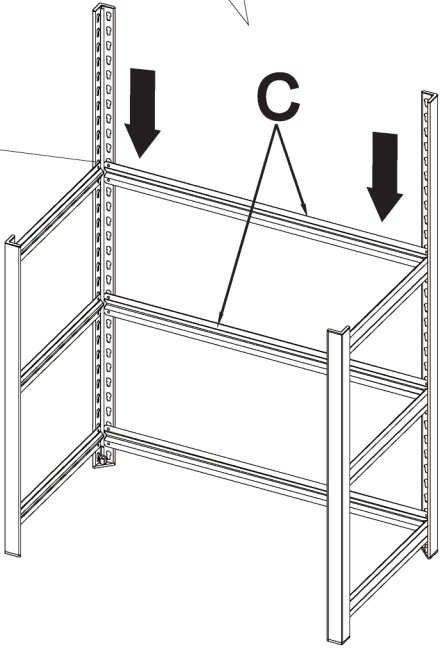
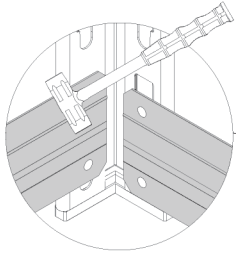

Note that the planes are aligned here

6

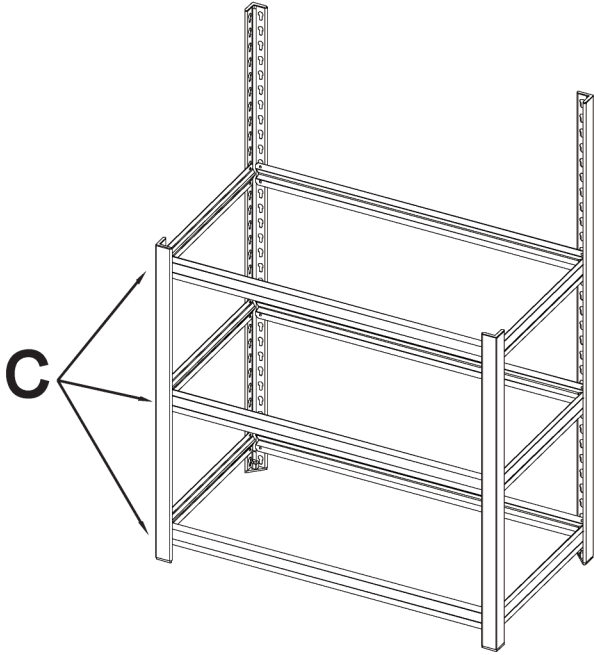

7

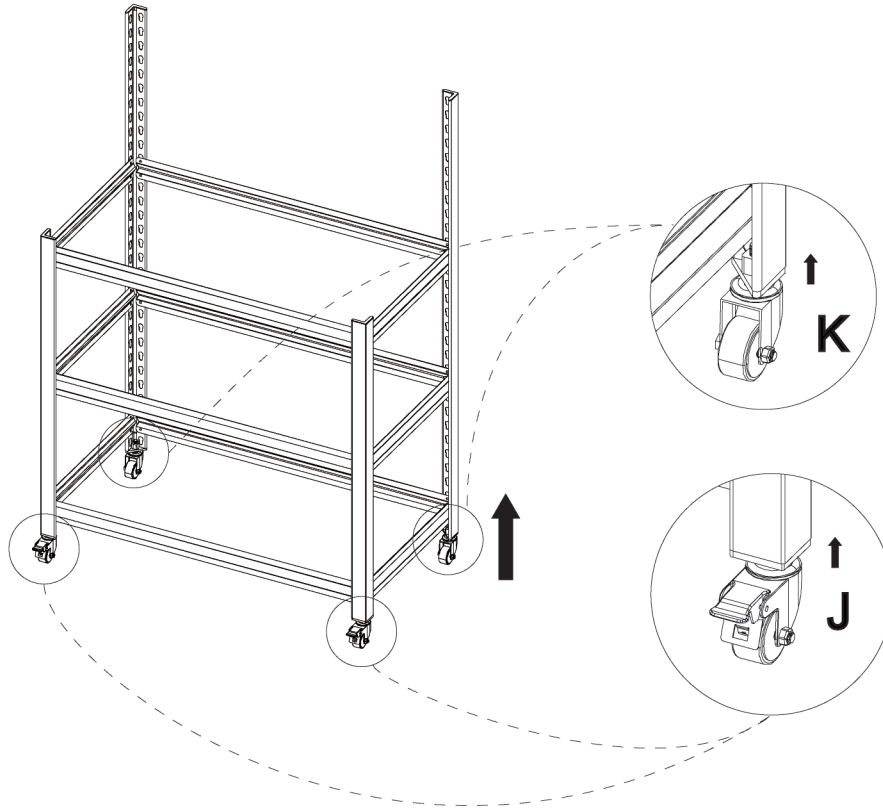

8

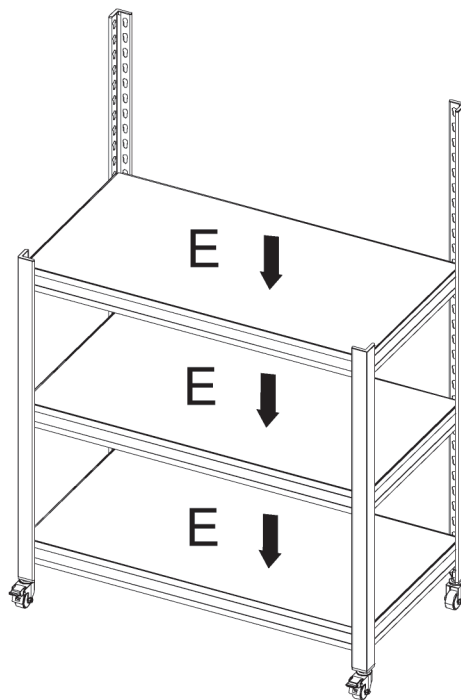

9

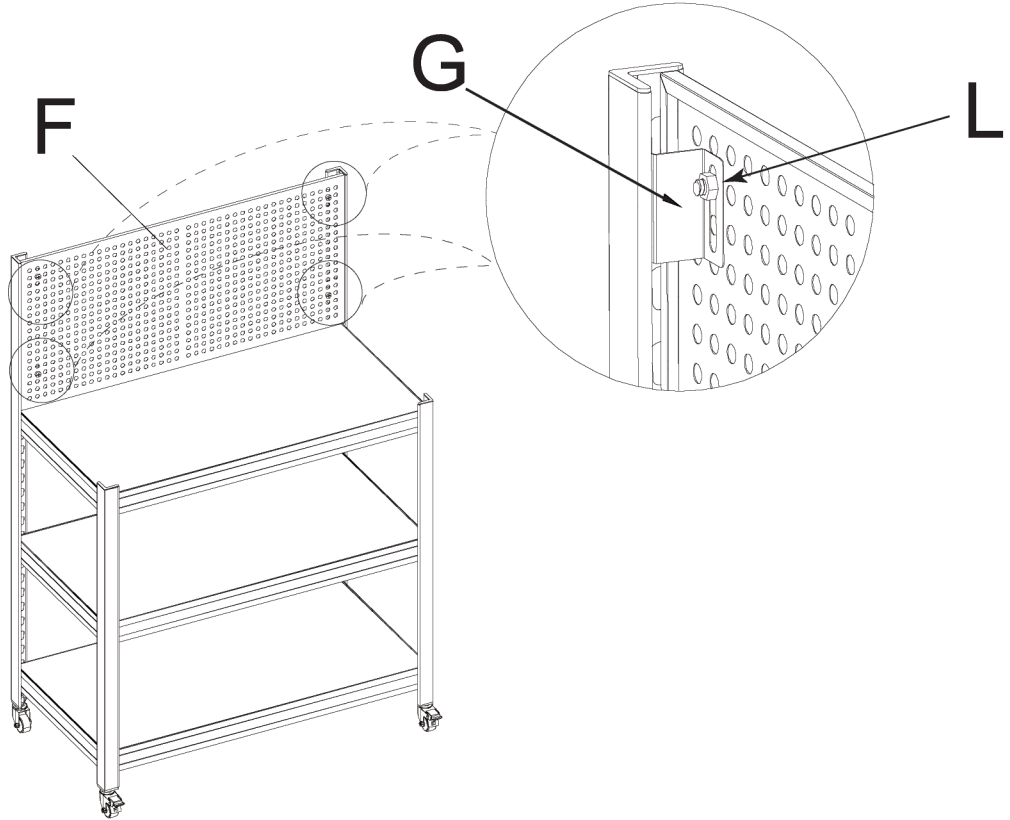

10

 This step connects the cabinet to the wall; skip it if not needed.

